



WOFI®

leben mit licht

...lights for living

Neuheiten 2018/2019

Novelties 2018/2019



Bitte beachten Sie, dass dies ein Ergänzungskatalog zum Katalog „Leben mit Licht“ 2018 ist, der weiterhin seine Gültigkeit behält.

Please note that this is a supplementary catalogue for the catalogue „Leben mit Licht“ 2018, which is still valid.



Gold & Silber / Gold & Silver



Modern / Modern



Kristall / Crystal



Retro / Retro



Cosy Living / Cosy Living



Wand- & Deckenleuchten / Wall & ceiling lights



Spotlightserien / Spotlight series



Gold & Silber

Gold & Silver

Einfach edel...

Die Farbe Gold hat ihren Namen vom gleichnamigen Edelmetall. Gold ist wegen seines „Sonnenglanzes“ schon seit frühen Zeiten das Metall der Götter, der Kaiser und der Könige. Die Farbe wird vor allem wegen ihrer warmen Wirkung geschätzt. Bei Einrichtungsaccessoires kehrt diese immer häufiger auch in moderne Wohnräume zurück.

Simply noble...

The colour gold takes its name from the precious metal of the same name. Gold has been the metal of gods, emperors and kings since early days because of its radiance. The colour is mainly appreciated because of its warm effect. When using furnishing with an accessory character, this also increasingly reflected in modern living spaces.

SAFIRA | Seite 4 - 6

ANGERS | Seite 7

ELIOT | Seite 8 - 11

OPUS | Seite 12 - 13

JULS | Seite 14



LED LIGHT by
WOFI®

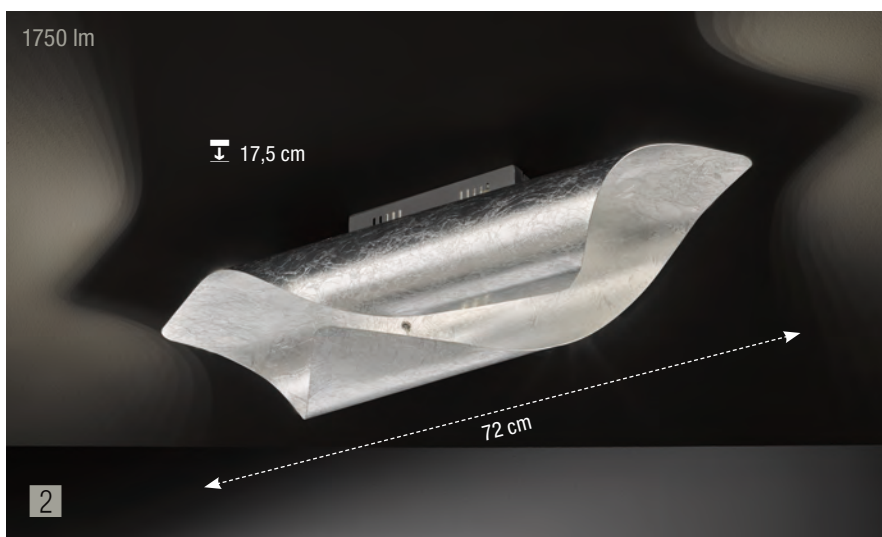
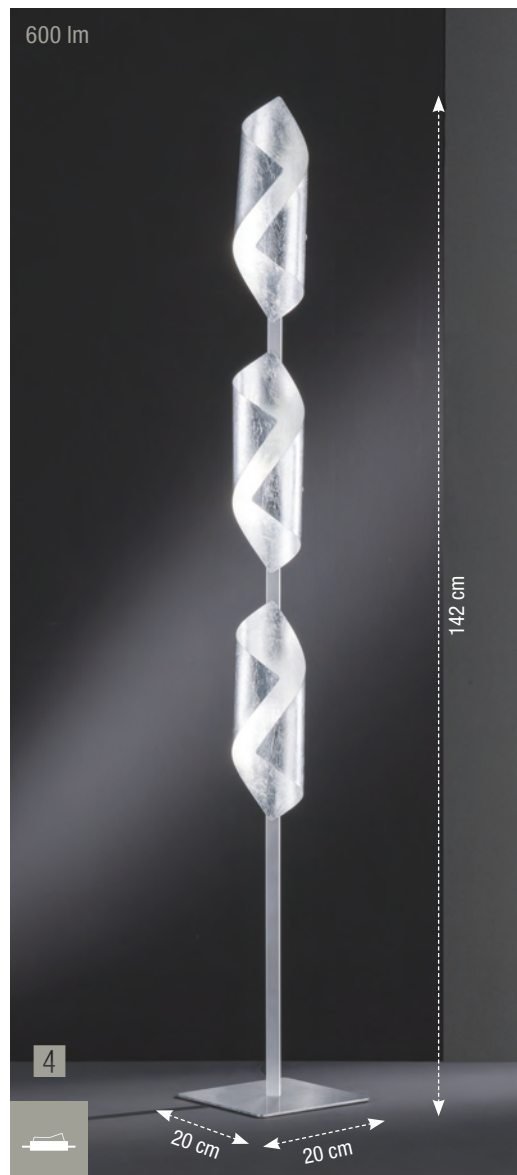
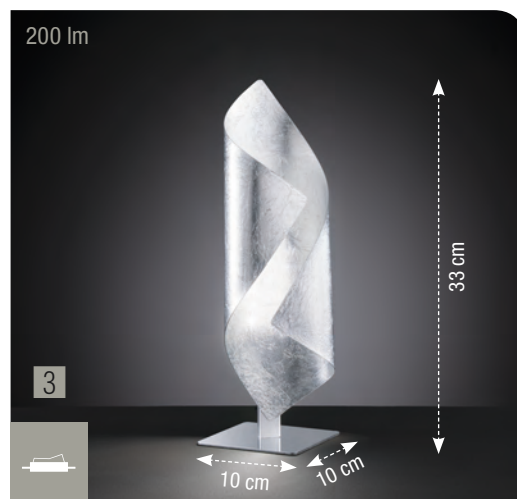
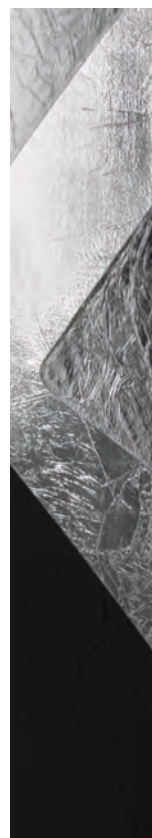
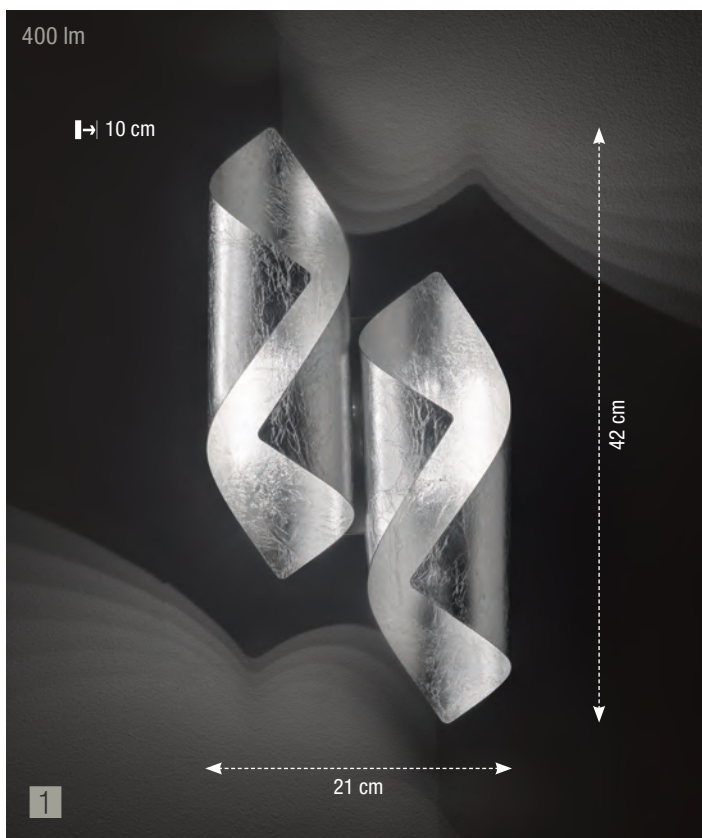

Serie / Series	EAN-Nr. / EAN-No.	Material / Material	Leuchtmittel / Lamp	Kelvin / Kelvin	Lumen / Lumen	Glas / Glass	Eek / EEC
1 Safira 325 4325.02.70.8000	4003474348605	Silber / Silver	2 x LED / 3 W (incl.)	3000 K	2 x 200 lm		A
2 Safira 325 9325.01.70.8000	4003474348629	Silber / Silver	1 x LED / 26 W (incl.)	3000 K	1 x 1750 lm		A
3 Safira 325 8325.01.70.8000	4003474348568	Silber / Silver	1 x LED / 3 W (incl.)	3000 K	1 x 200 lm		A+
4 Safira 325 3325.03.70.8000	4003474348582	Silber / Silver	3 x LED / 3 W (incl.)	3000 K	3 x 200 lm		A

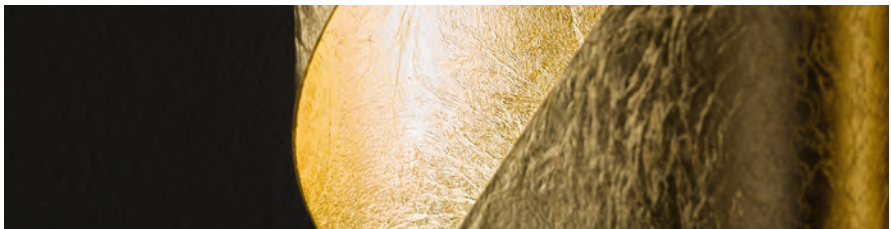
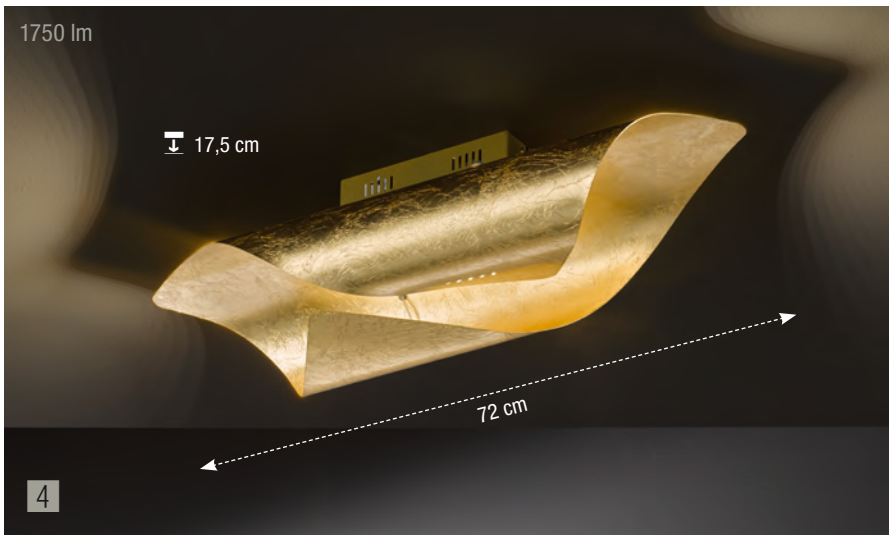
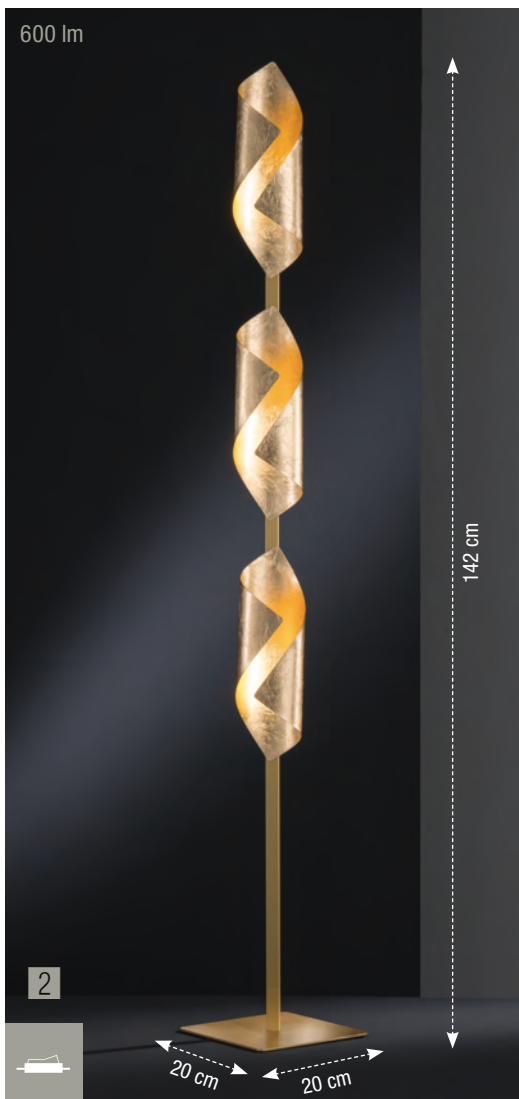
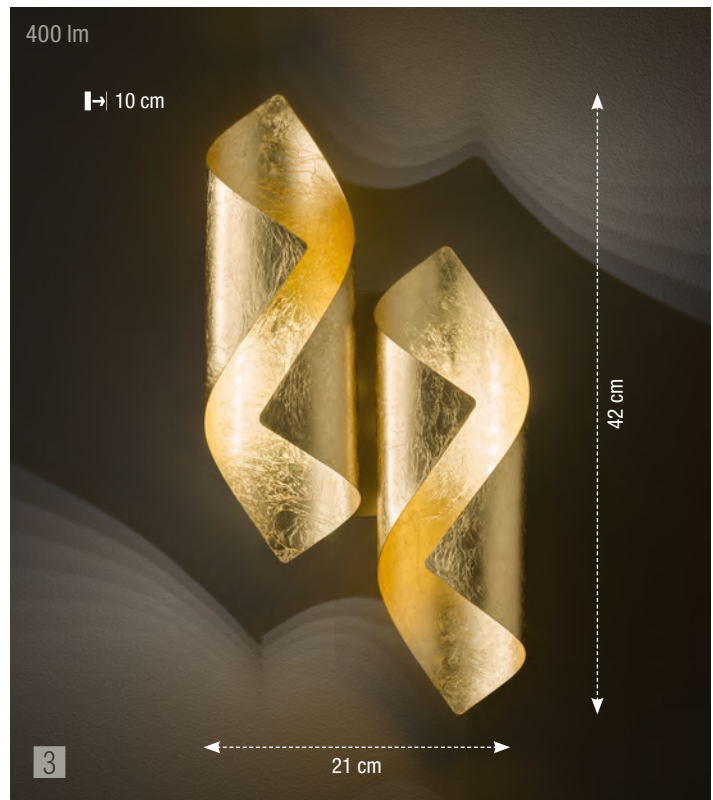
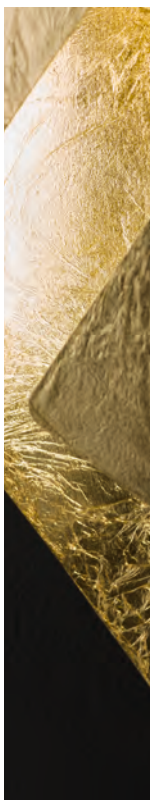
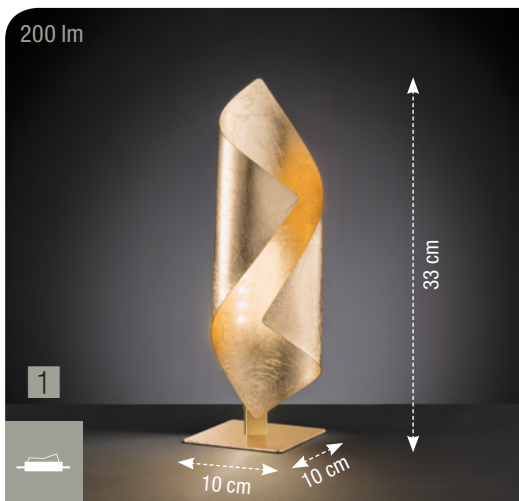

	Serie / Series	EAN-Nr. / EAN-No.	Material / Material	Leuchtmittel / Lamp	Kelvin / Kelvin	Lumen / Lumen	Glas / Glass	EEK / EEC
1	Safira 325 8325.01.15.8000	4003474348551	Goldfarbig / Gold coloured	1 x LED / 3 W (incl.)	3000 K	1 x 200 lm		A+
2	Safira 325 3325.03.15.8000	4003474348575	Goldfarbig / Gold coloured	3 x LED / 3 W (incl.)	3000 K	3 x 200 lm		A
3	Safira 325 4325.02.15.8000	4003474348599	Goldfarbig / Gold coloured	2 x LED / 3 W (incl.)	3000 K	2 x 200 lm		A
4	Safira 325 9325.01.15.8000	4003474348612	Goldfarbig / Gold coloured	1 x LED / 26 W (incl.)	3000 K	1 x 1750 lm		A

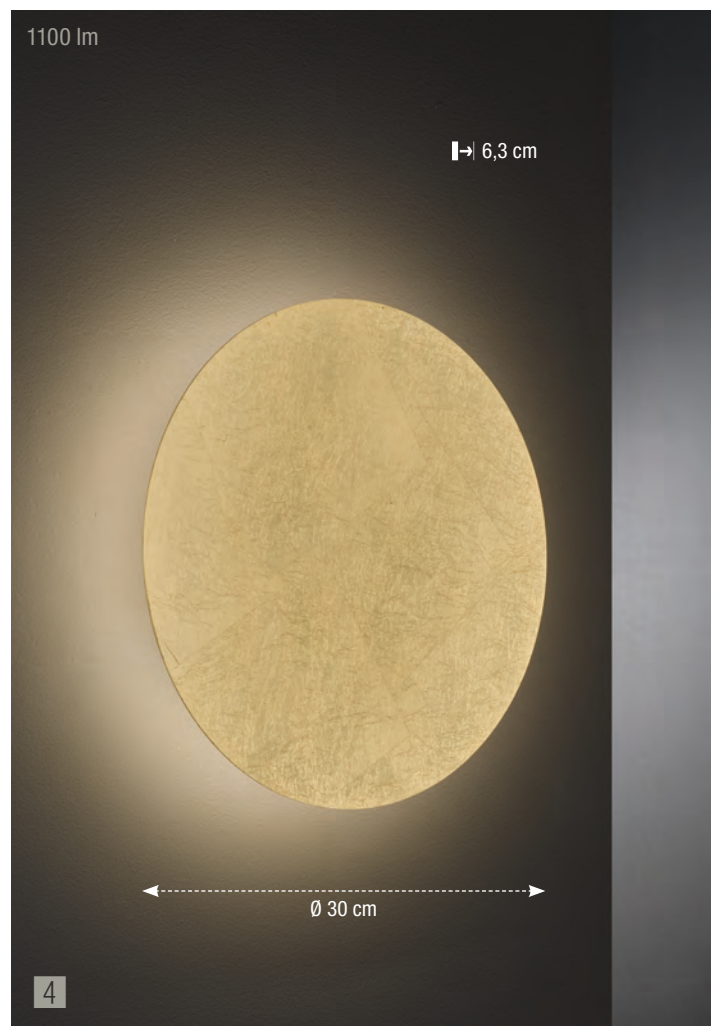
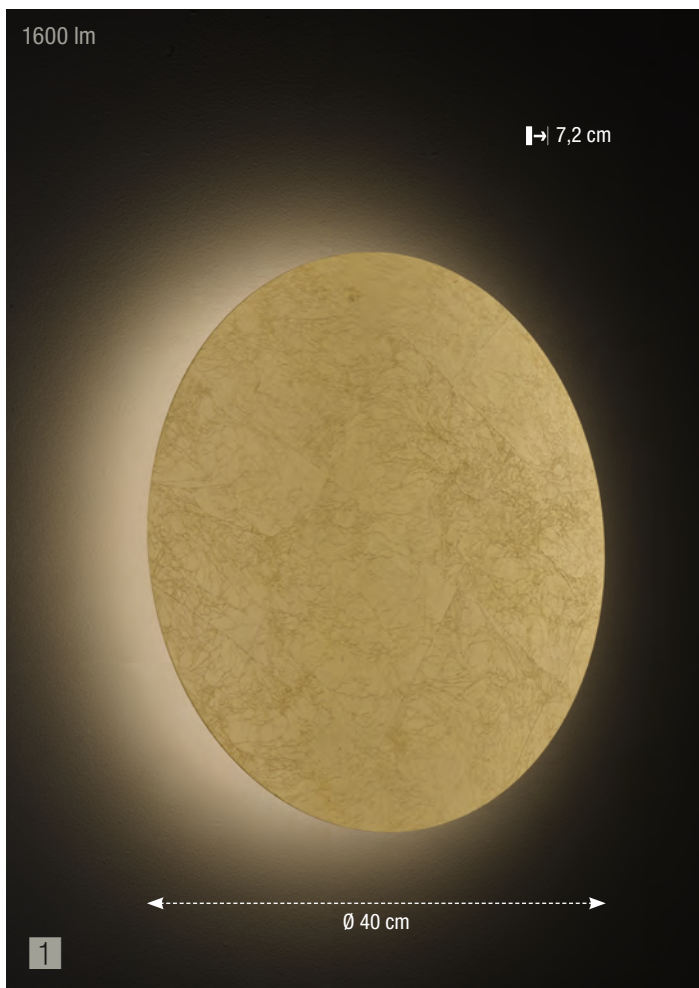

Serie / Series	EAN-Nr. / EAN-No.	Material / Material	Leuchtmittel / Lamp	Kelvin / Kelvin	Lumen / Lumen	Glas / Glass	EEK / EEC
1 Angers 330 4330.01.15.8400	4003474348667	Goldfarbig / Gold coloured	1 x LED / 18 W (incl.)	3000 K	1 x 1600 lm		A
2 Angers 330 4330.01.15.8170	4003474348643	Goldfarbig / Gold coloured	1 x LED / 6 W (incl.)	3000 K	1 x 600 lm		A+
3 Angers 330 4330.01.15.8120	4003474348636	Goldfarbig / Gold coloured	1 x LED / 5 W (incl.)	3000 K	1 x 400 lm		A+
4 Angers 330 4330.01.15.8300	4003474348650	Goldfarbig / Gold coloured	1 x LED / 12 W (incl.)	3000 K	1 x 1100 lm		A+

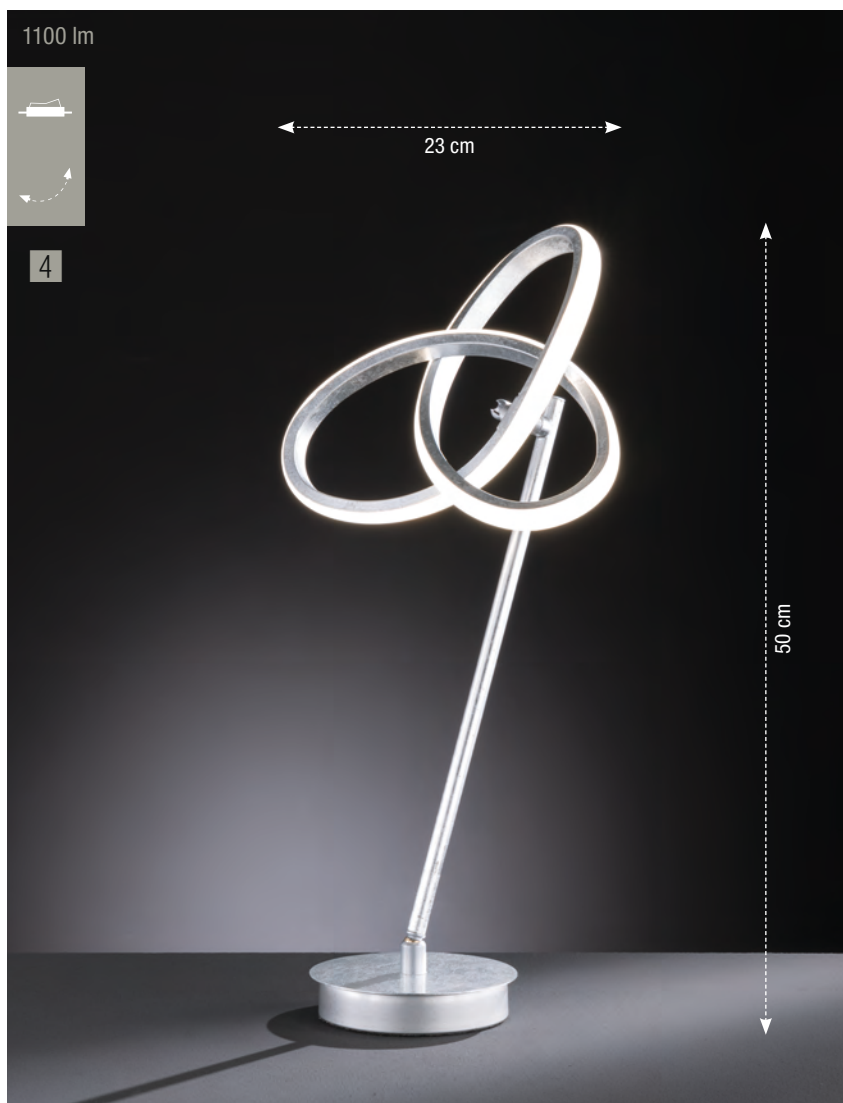
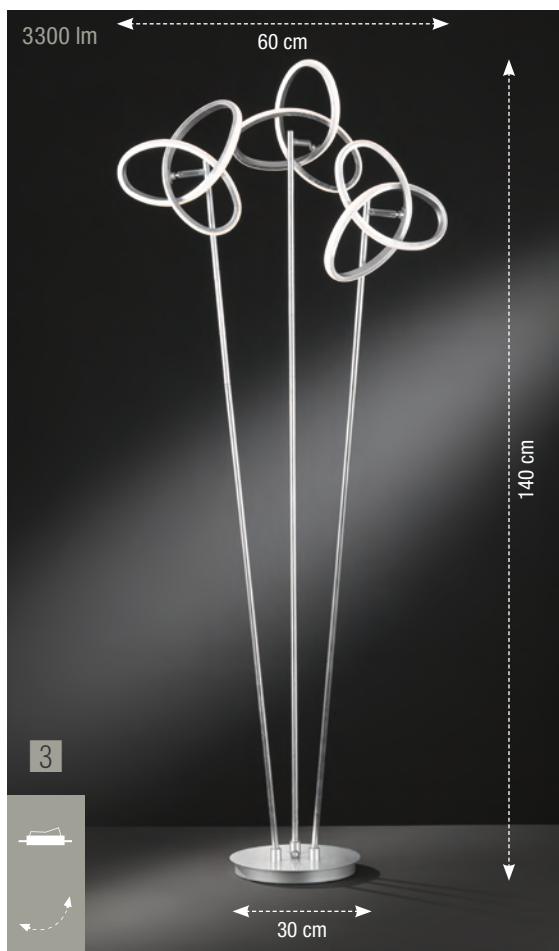
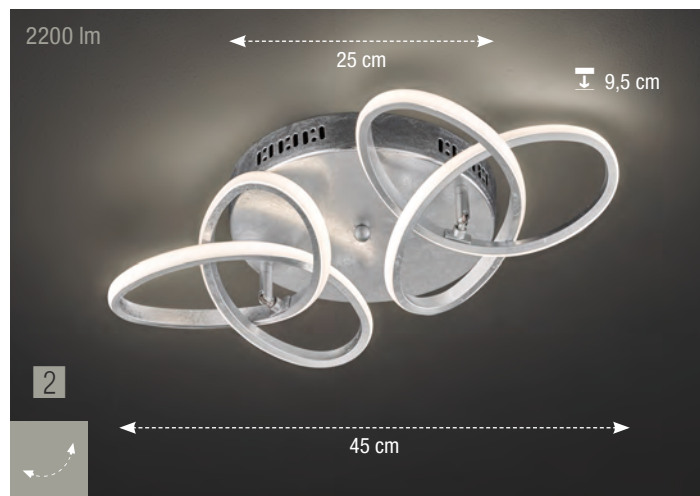
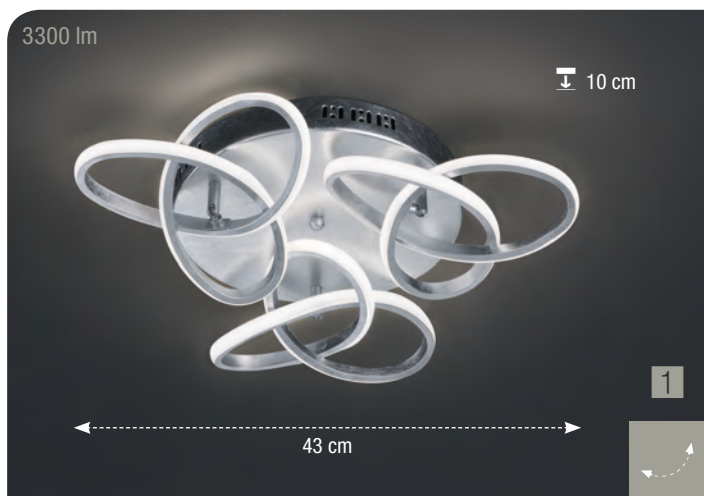

Serie / Series	EAN-Nr. / EAN-No.	Material / Material	Leuchtmittel / Lamp	Kelvin / Kelvin	Lumen / Lumen	Glas / Glass	EEK / EEC
1 Eliot 410 9410.03.70.8000	4003474349312	Silber / Silver	3 x LED / 13 W (incl.) LED Board	3000 K	3 x 1100 lm		A
2 Eliot 410 9410.02.70.8000	4003474349305	Silber / Silver	2 x LED / 13 W (incl.) LED Board	3000 K	2 x 1100 lm		A
3 Eliot 410 3410.03.70.8000	4003474349367	Silber / Silver	3 x LED / 13 W (incl.) LED Board	3000 K	3 x 1100 lm		A
4 Eliot 410 8410.01.70.8000	4003474349350	Silber / Silver	1 x LED / 13 W (incl.) LED Board	3000 K	1 x 1100 lm		A

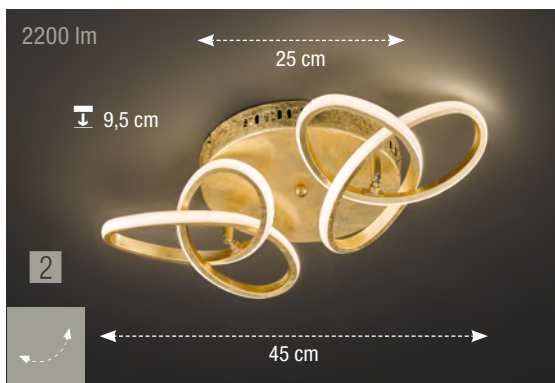
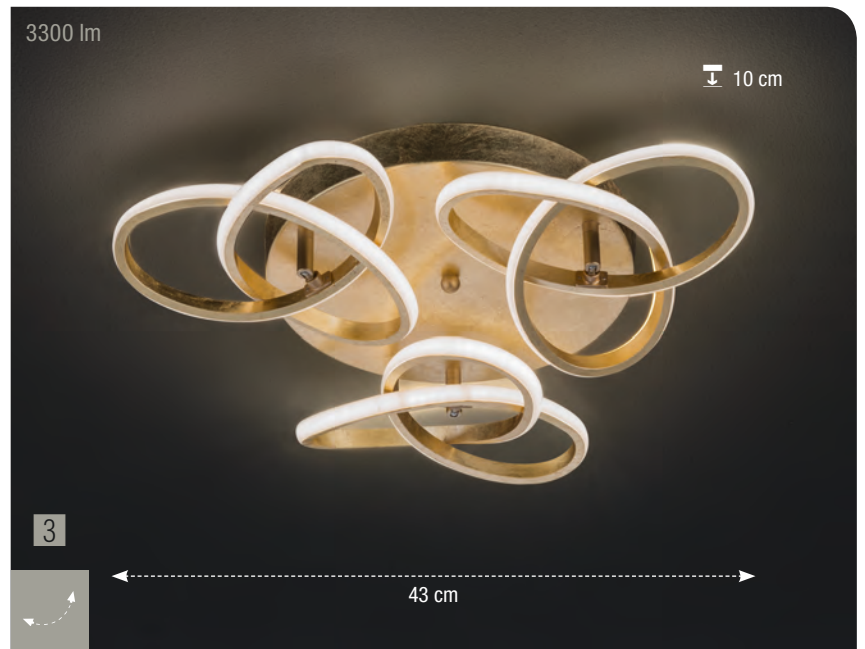

Serie / Series	EAN-Nr. / EAN-No.	Material / Material	Leuchtmittel / Lamp	Kelvin / Kelvin	Lumen / Lumen	Glas / Glass	EEK / EEC
1 Eliot 410 3410.03.15.8000	4003474349299	Goldfarbig / Gold coloured	3 x LED / 13 W (incl.) LED Board	3000 K	3 x 1100 lm		A
2 Eliot 410 9410.02.15.8000	4003474349237	Goldfarbig / Gold coloured	2 x LED / 13 W (incl.) LED Board	3000 K	2 x 1100 lm		A
3 Eliot 410 9410.03.15.8000	4003474349244	Goldfarbig / Gold coloured	3 x LED / 13 W (incl.) LED Board	3000 K	3 x 1100 lm		A
4 Eliot 410 8410.01.15.8000	4003474349282	Goldfarbig / Gold coloured	1 x LED / 13 W (incl.) LED Board	3000 K	1 x 1100 lm		A

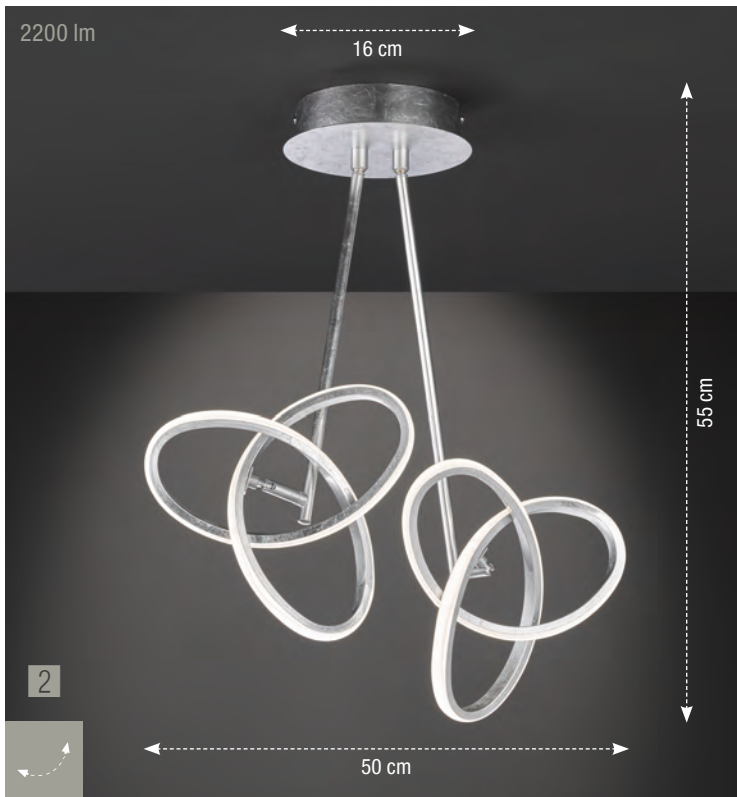
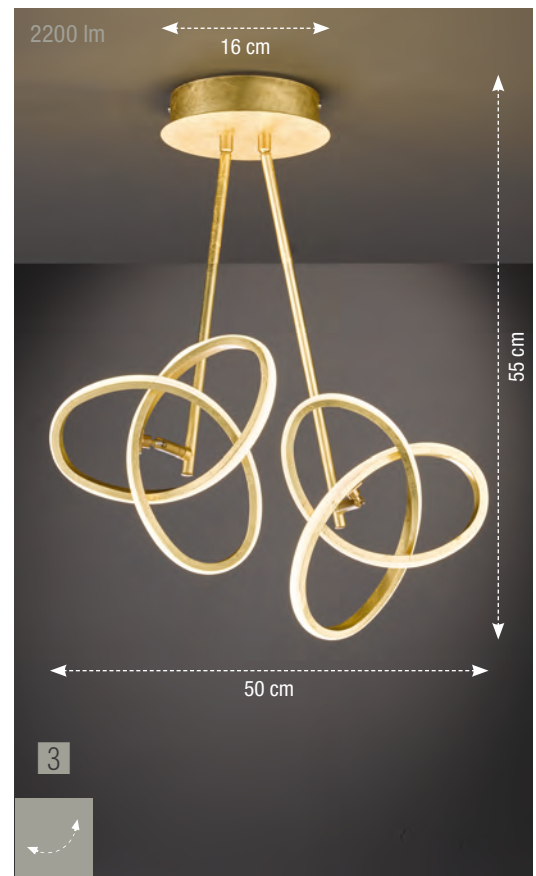





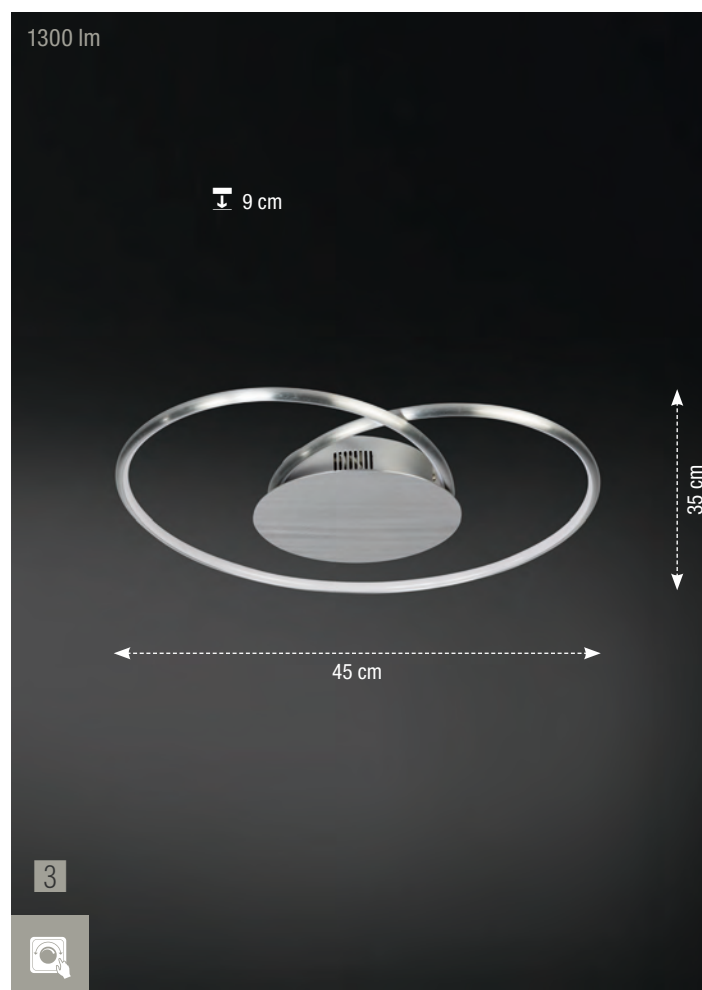
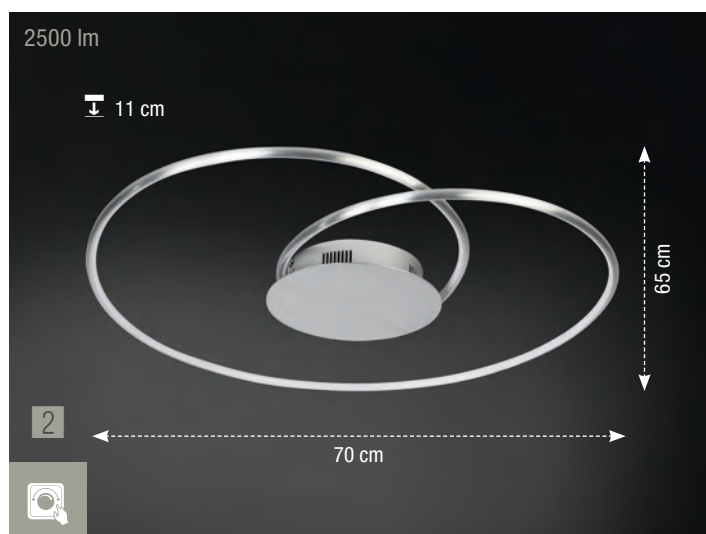
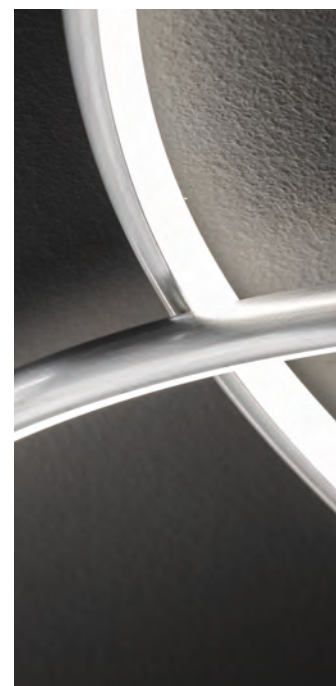
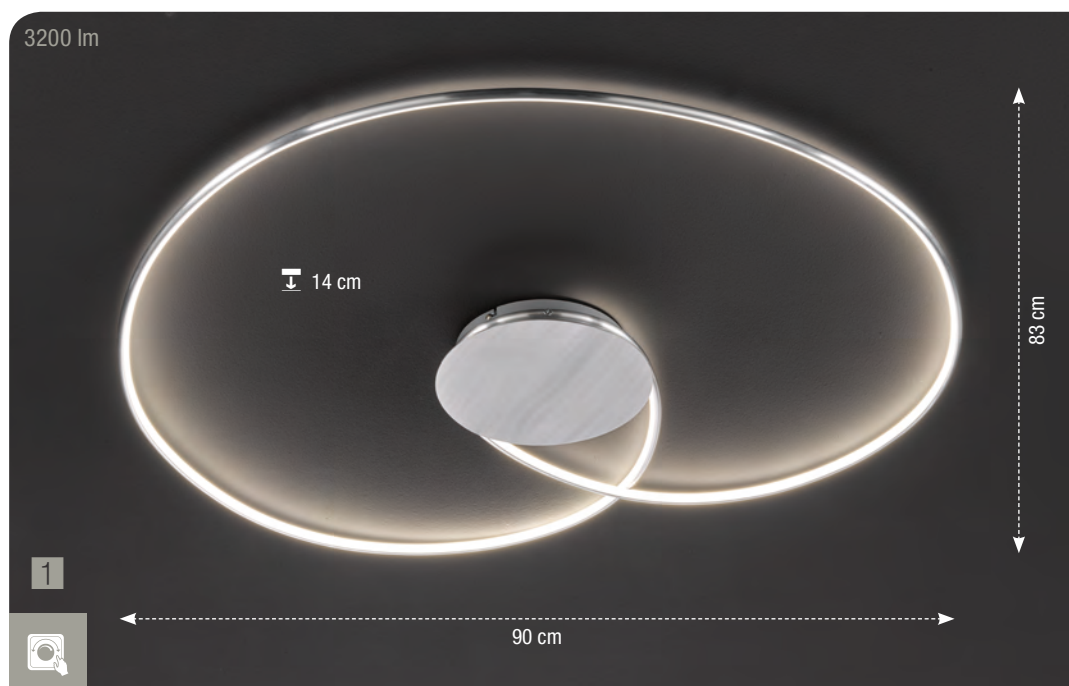

Serie / Series	EAN-Nr. / EAN-No.	Material / Material	Leuchtmittel / Lamp	Kelvin / Kelvin	Lumen / Lumen	Glas / Glass	EEK / EEC
1 Eliot 410 9410.03.70.8100	4003474349343	Silber / Silver	3 x LED / 13 W (incl.) LED Board	3000 K	3 x 1100 lm		A
2 Eliot 410 9410.02.70.8100	4003474349336	Silber / Silver	2 x LED / 13 W (incl.) LED Board	3000 K	2 x 1100 lm		A
3 Eliot 410 9410.02.15.8100	4003474349268	Goldfarbig / Gold coloured	2 x LED / 13 W (incl.) LED Board	3000 K	2 x 1100 lm		A
4 Eliot 410 9410.03.15.8100	4003474349275	Goldfarbig / Gold coloured	3 x LED / 13 W (incl.) LED Board	3000 K	3 x 1100 lm		A







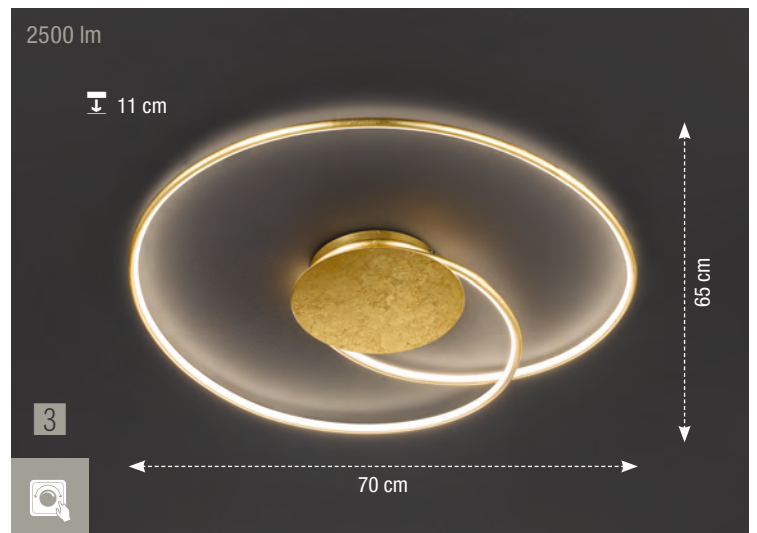
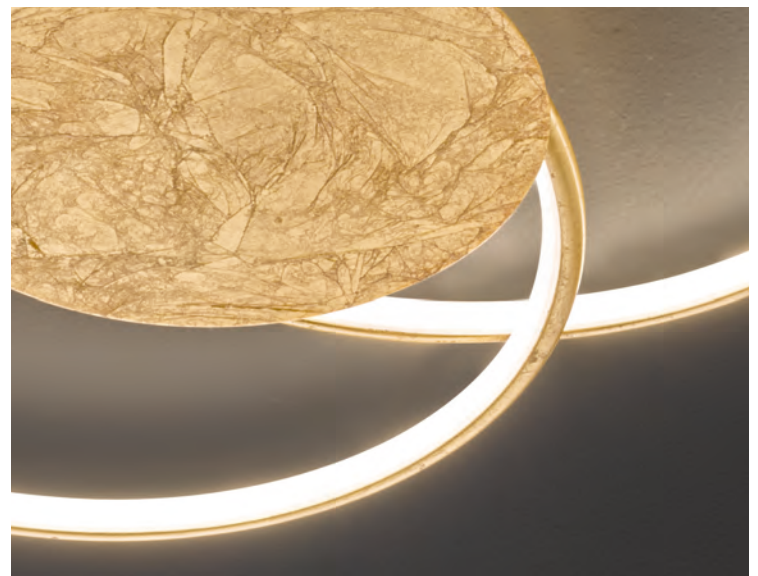
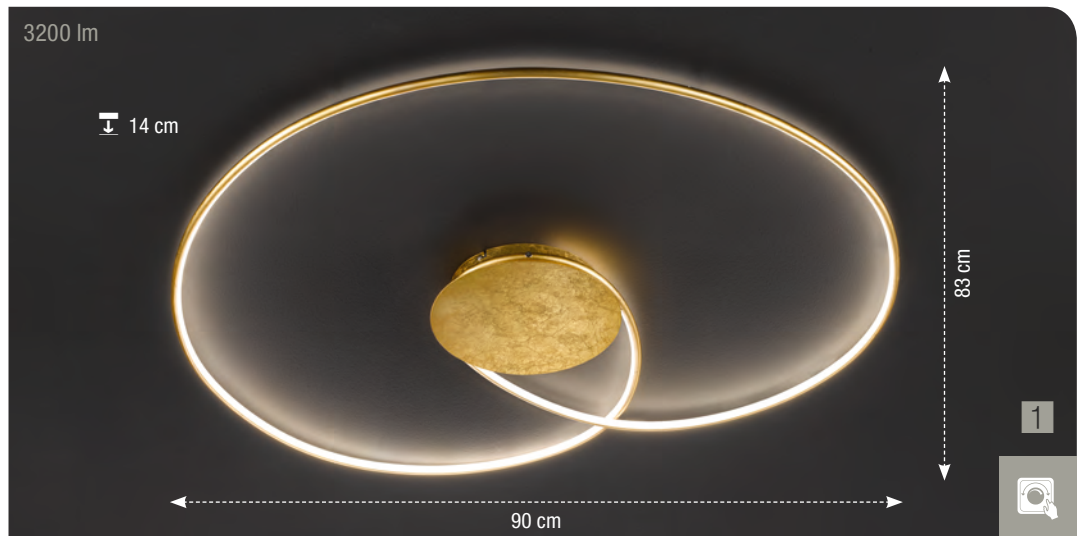
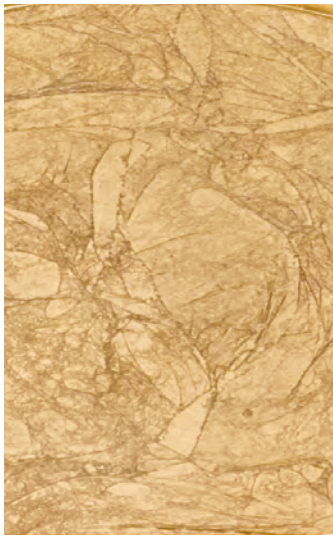

Serie / Series	EAN-Nr. / EAN-No.	Material / Material	Leuchtmittel / Lamp	Kelvin / Kelvin	Lumen / Lumen	Glas / Glass	EEK / EEC
1 Eliot I 410 6410.03.15.8000	4003474349251	Goldfarbig / Gold coloured	3 x LED / 13 W (incl.) LED Board	3000 K	3 x 1100 lm		
2 Eliot I 410 6410.03.70.8000	4003474349329	Silber / Silver	3 x LED / 13 W (incl.) LED Board	3000 K	3 x 1100 lm		







	Serie / Series	EAN-Nr. / EAN-No.	Material / Material	Leuchtmittel / Lamp	Kelvin / Kelvin	Lumen / Lumen	Glas / Glass	EEK / EEC
1	Opus I 422 9422.01.63.8900	4003474346984	Aluminium gebürstet / Aluminium brushed finished	 1 x LED / 32 W (incl.)	3000 K	1 x 3200 lm		
2	Opus I 422 9422.01.63.8700	4003474346960	Aluminium gebürstet / Aluminium brushed finished	 1 x LED / 31 W (incl.)	3000 K	1 x 2500 lm		
3	Opus I 422 9422.01.63.8450	4003474346953	Aluminium gebürstet / Aluminium brushed finished	 1 x LED / 16 W (incl.)	3000 K	1 x 1300 lm		

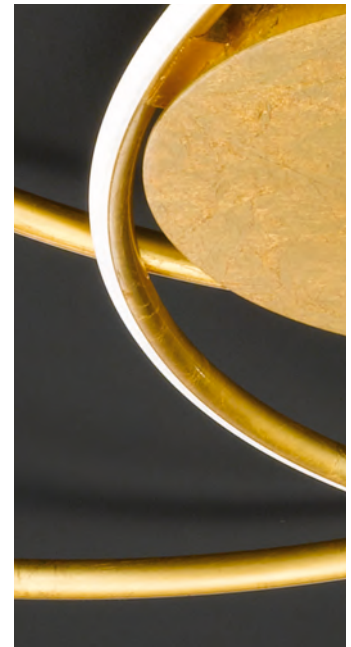
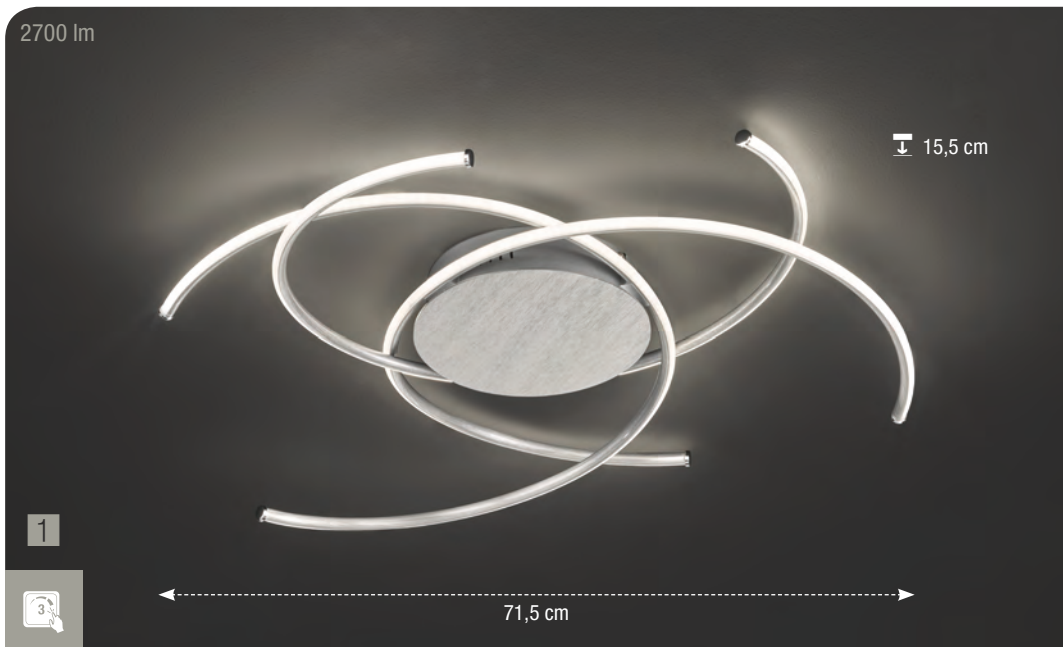

	Serie / Series	EAN-Nr. / EAN-No.	Material / Material	Leuchtmittel / Lamp	Kelvin / Kelvin	Lumen / Lumen	Glas / Glass	EEK / EEC
1	Opus 422 9422.01.15.8900	4003474346977	Goldfarbig / Gold coloured	 1 x LED / 32 W (incl.)	3000 K	1 x 3200 lm		
2	Opus 422 9422.01.15.8450	4003474346939	Goldfarbig / Gold coloured	 1 x LED / 16 W (incl.)	3000 K	1 x 1300 lm		
3	Opus 422 9422.01.15.8700	4003474346946	Goldfarbig / Gold coloured	 1 x LED / 31 W (incl.)	3000 K	1 x 2500 lm		



	Serie / Series	EAN-Nr. / EAN-No.	Material / Material	Leuchtmittel / Lamp	Kelvin / Kelvin	Lumen / Lumen	Glas / Glass	EEK / EEC
1	Juls 344 9344.03.63.8000	4003474347004	Aluminium gebürstet / Aluminium brushed finished	 LED / 24 W (incl.)	3000 K	2700 lm		
2	Juls 344 9344.03.15.8000	4003474346991	Goldfarbig / Gold coloured	 LED / 24 W (incl.)	3000 K	2700 lm		

Weitere attraktive Leuchten in den Farben Gold bzw. Silber
finden Sie auf den folgenden Seiten:

*Additional attractive lamps in the colours gold or silver
please find on the following pages:*

INDIGO | 134
6134.01.70.8000
Seite / Page 29



INDIGO | 134
9134.01.70.8000
Seite / Page 29



DINA | 185
6185.06.15.8000
Seite / Page 55



DINA | 185
8185.03.15.8000
Seite / Page 55



DINA | 185
3185.05.15.8000
Seite / Page 55



AVERY | 188
9188.07.15.8000
Seite / Page 56

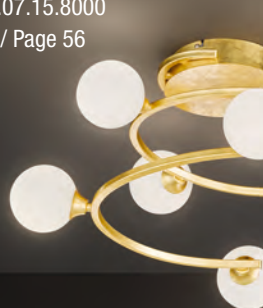

VERRE | 399
8399.01.15.8150
Seite / Page 56



DYLAN | 351
3351.01.15.8000
Seite / Page 59



DYLAN | 351
8351.01.15.8000
Seite / Page 59



BELLE | 268
8268.03.15.8000
Seite / Page 68



BELLE | 268
9268.02.15.8400
Seite / Page 68

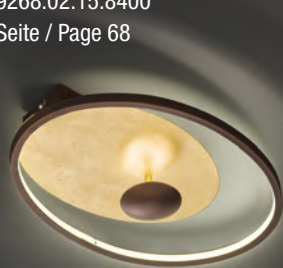

BELLE | 268
9268.02.15.8300
Seite / Page 68

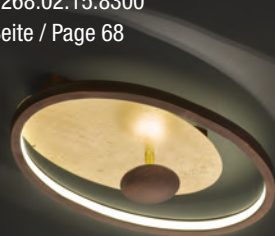

QUEBEC | 416
4416.01.15.8000
Seite / Page 85

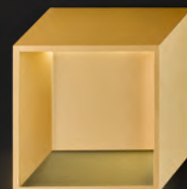

GALWAY | 567
4567.01.15.8000
Seite / Page 85





Modern

Modern

Innovationen für Morgen

Seit der Erfindung der Glühlampe hat sich viel getan. Nicht nur in der Technologie, sondern auch im Design. So hat sich manche praktische Lichtquelle inzwischen zu einem modernen Leuchtoobjekt entwickelt und wird immer öfter als schöner Blickfang platziert.

Innovations for tomorrow

Much has changed since the invention of the light bulb – both in terms of technology and design. Many practical light sources have become modern lighting objects and are being used as beautiful eye catchers.

VISO | Seite 18 - 22

MODESTO | Seite 23

SKIP | Seite 24 - 25

MONTREAL | Seite 26

SIGNE | Seite 27

LIVIA | Seite 28

INDIGO | Seite 29

SPRING | Seite 30

RISA | Seite 30

KIT | Seite 31

SYDNEY | Seite 32 - 33

AURELIA | Seite 34 - 35



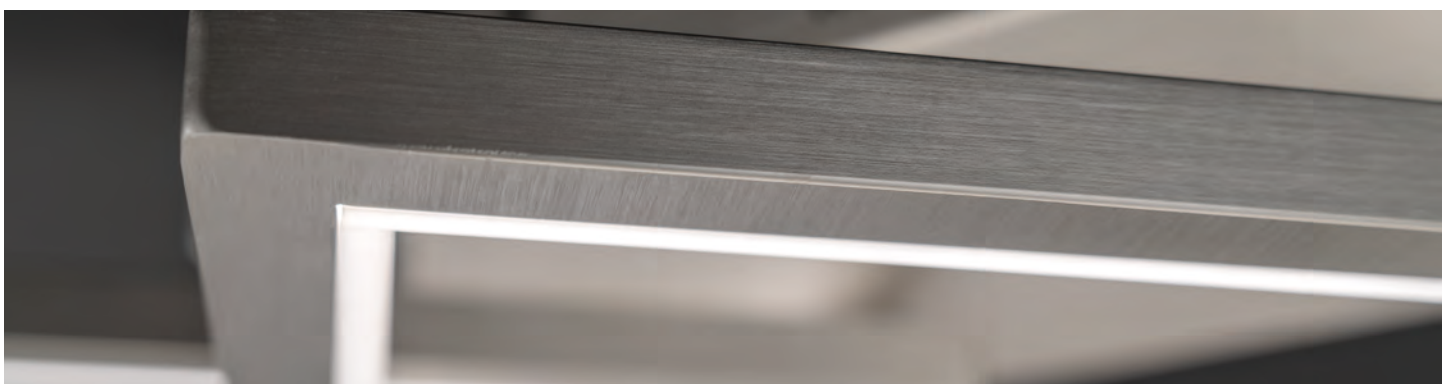
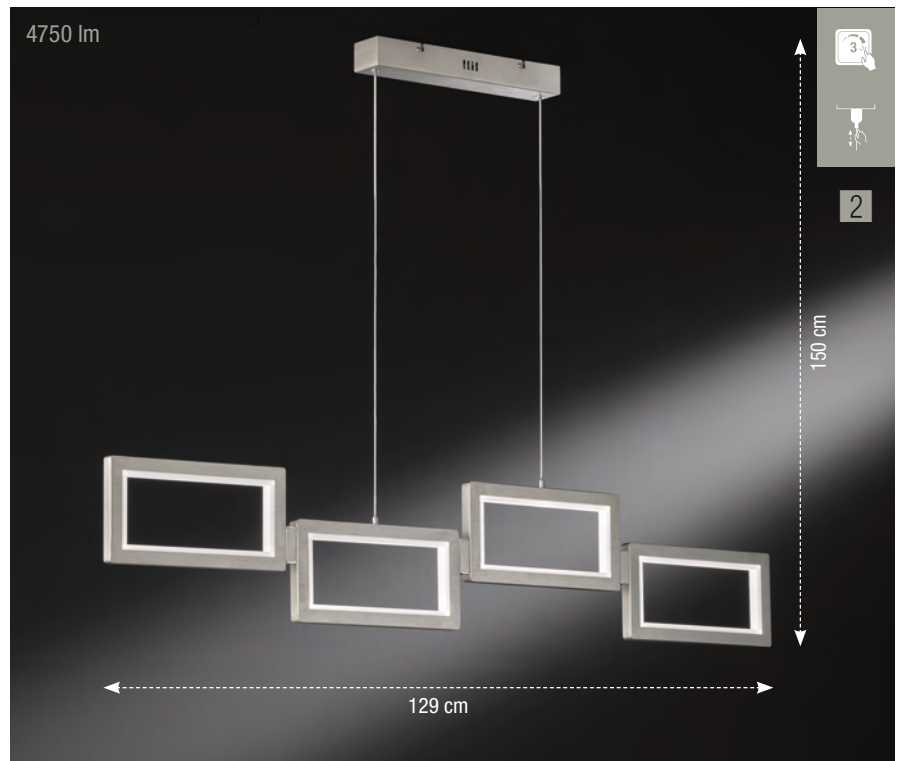
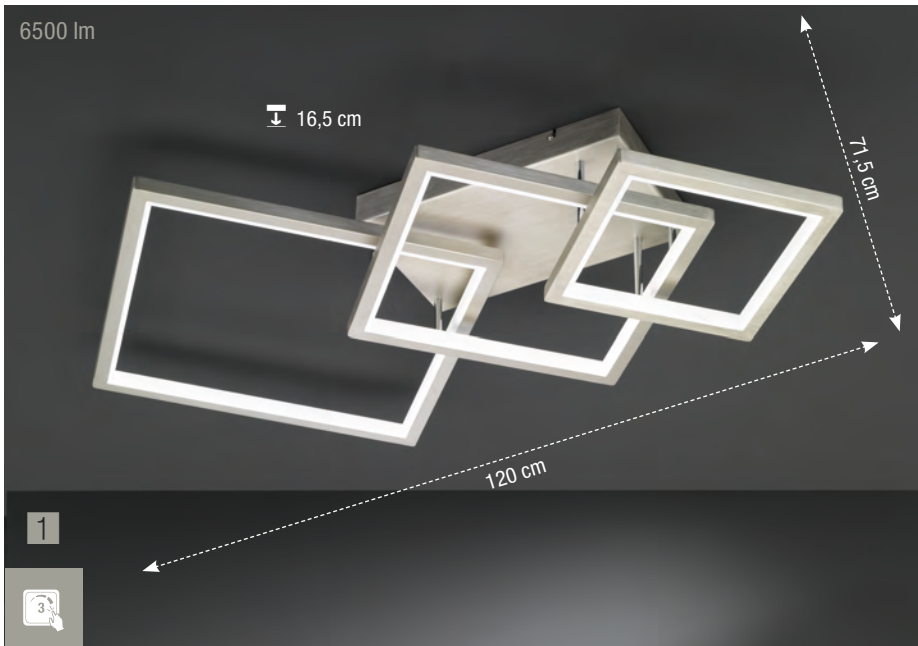

Serie / Series	EAN-Nr. / EAN-No.	Material / Material	Leuchtmittel / Lamp	Kelvin / Kelvin	Lumen / Lumen	Glas / Glass	EEK / EEC
1 Viso 531 9531.03.64.8000	4003474347943	Nickel-matt / Nickel matt finished	LED / 93 W (incl.)	3000 K	6500 lm		
2 Viso 531 7531.04.64.8100	4003474348063	Nickel-matt / Nickel matt finished	LED / 66 W (incl.)	3000 K	4750 lm		

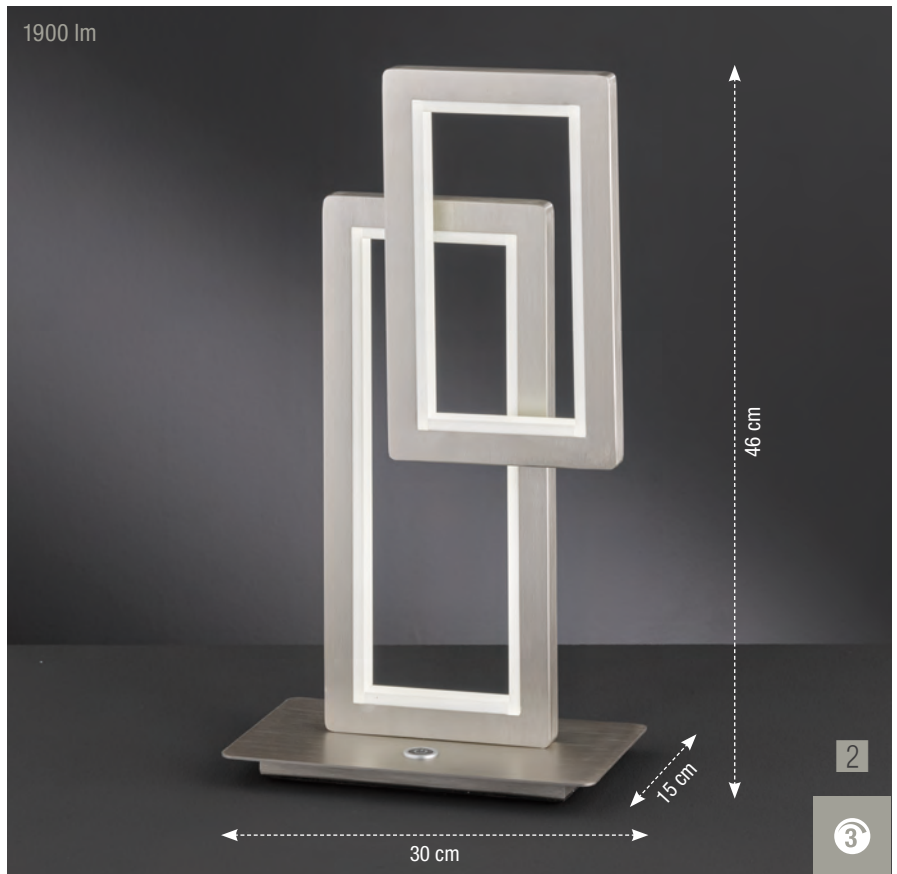
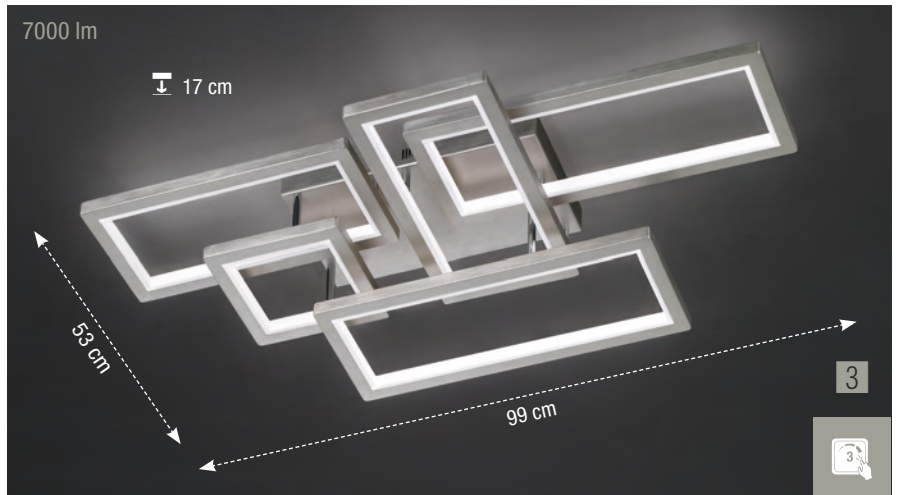
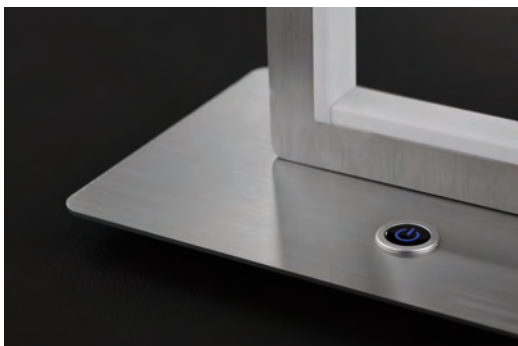
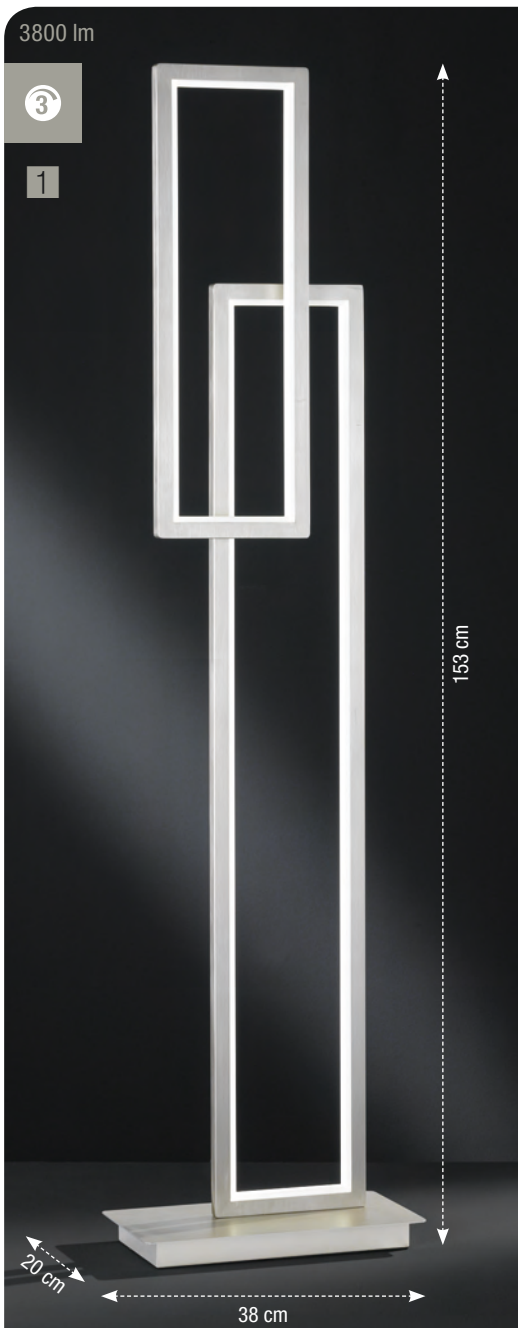

Serie / Series	EAN-Nr. / EAN-No.	Material / Material	Leuchtmittel / Lamp	Kelvin / Kelvin	Lumen / Lumen	Glas / Glass	EEK / EEC
1 VISO 531 3531.02.64.8000	4003474347974	Nickel-matt / Nickel matt finished	LED / 50 W (incl.)	3000 K	3800 lm		
2 VISO 531 8531.02.64.8000	4003474348056	Nickel-matt / Nickel matt finished	LED / 29 W (incl.)	3000 K	1900 lm		
3 VISO 531 9531.05.64.8000	4003474350370	Nickel-matt / Nickel matt finished	LED / 112 W (incl.)	3000 K	7000 lm		

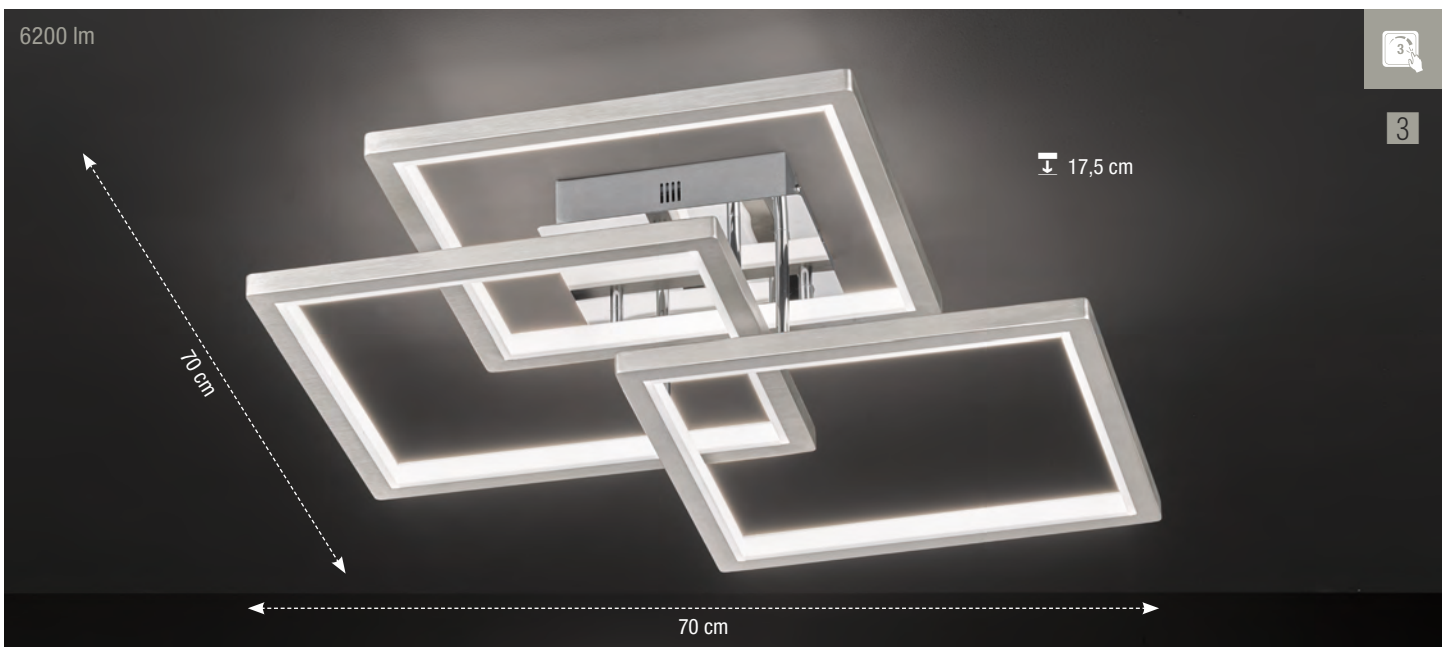
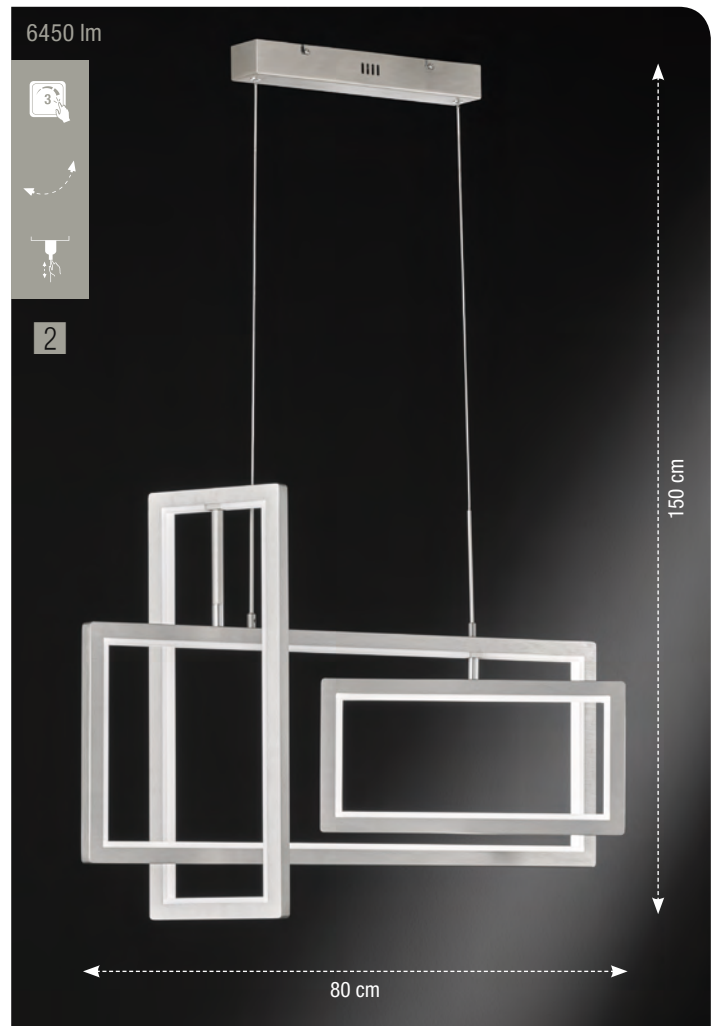
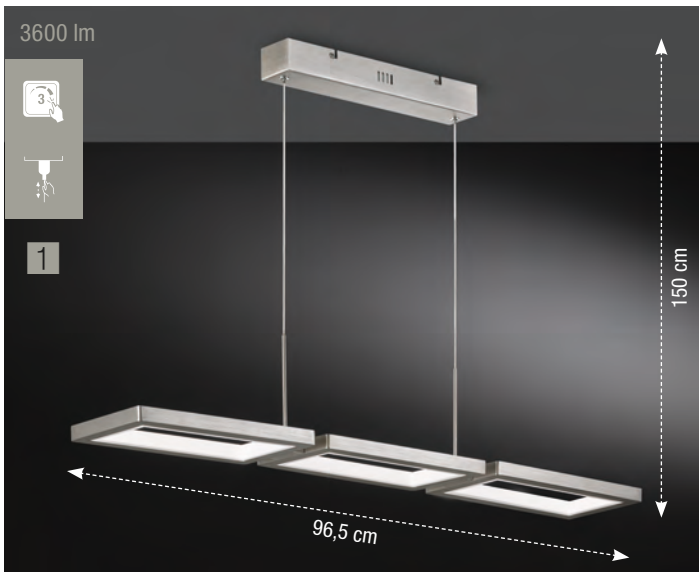
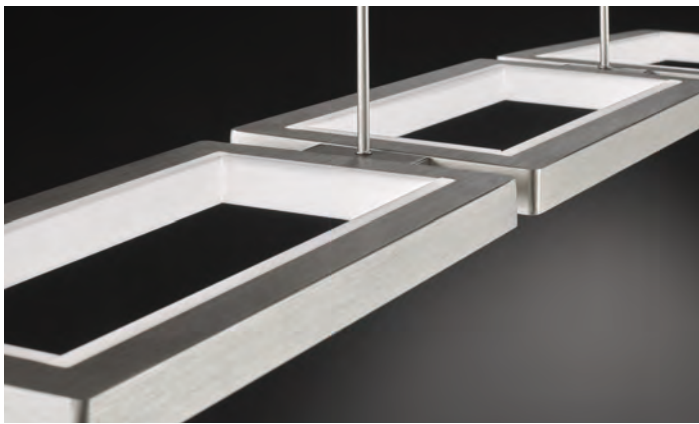



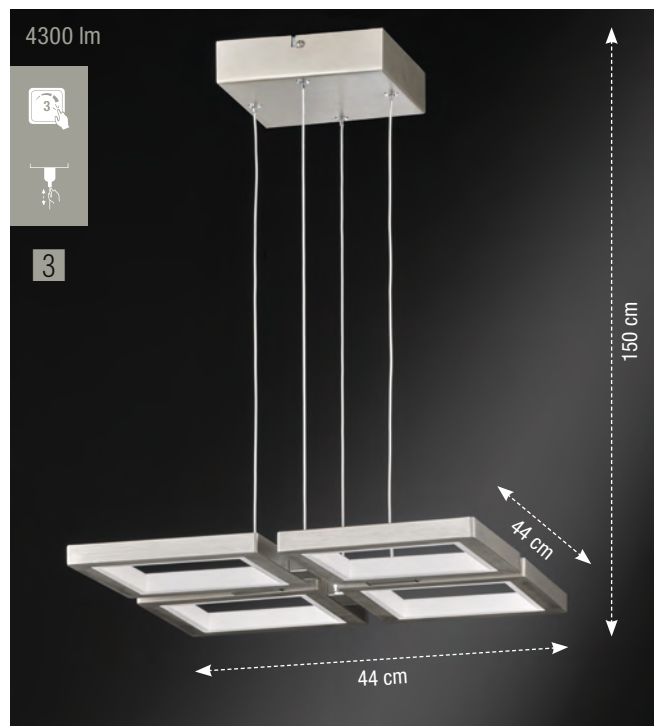
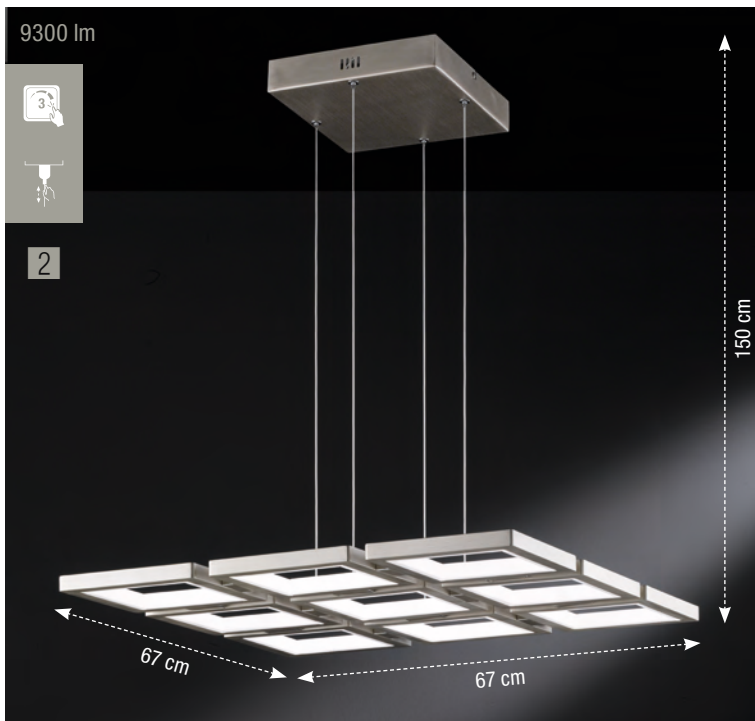
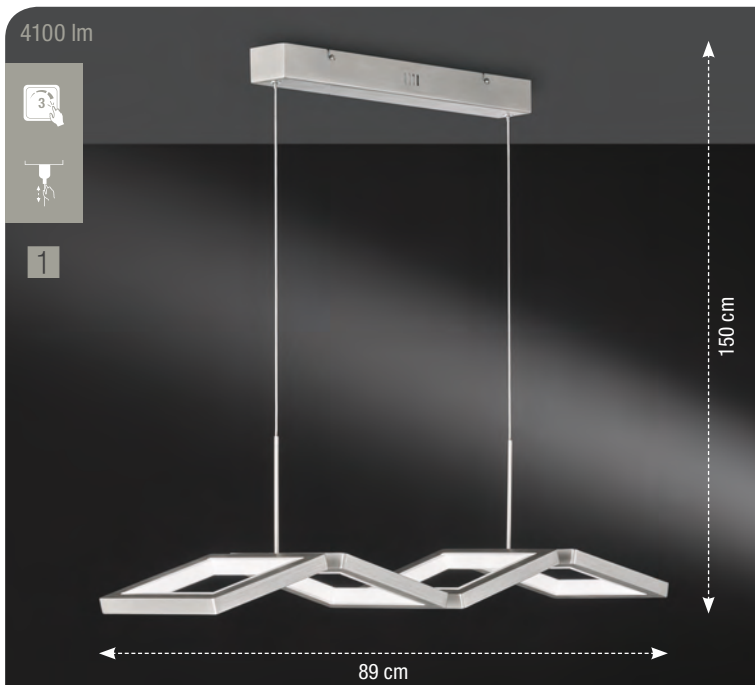

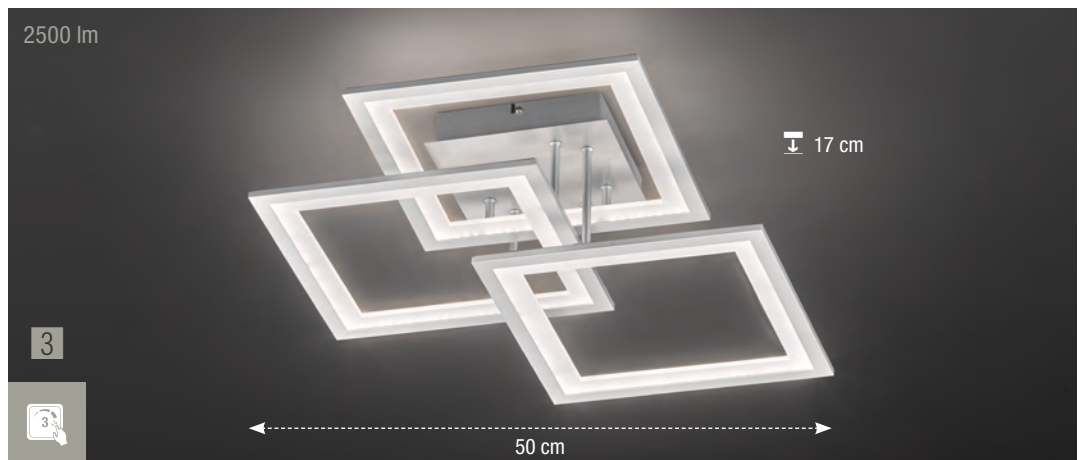
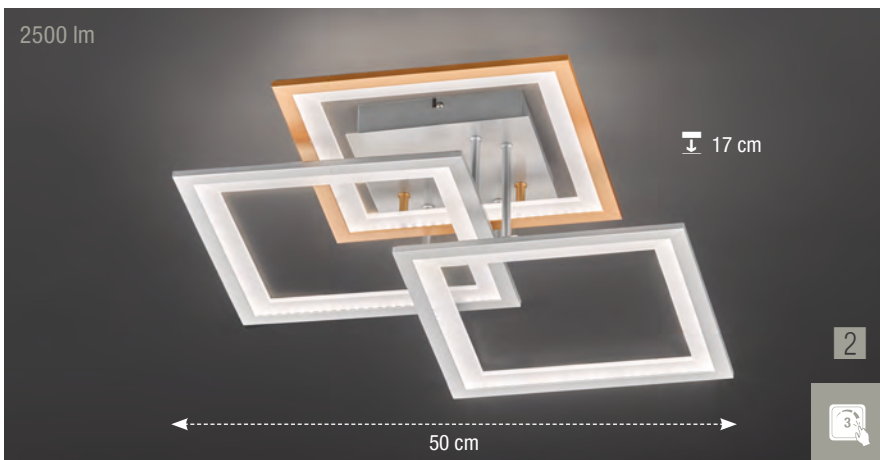
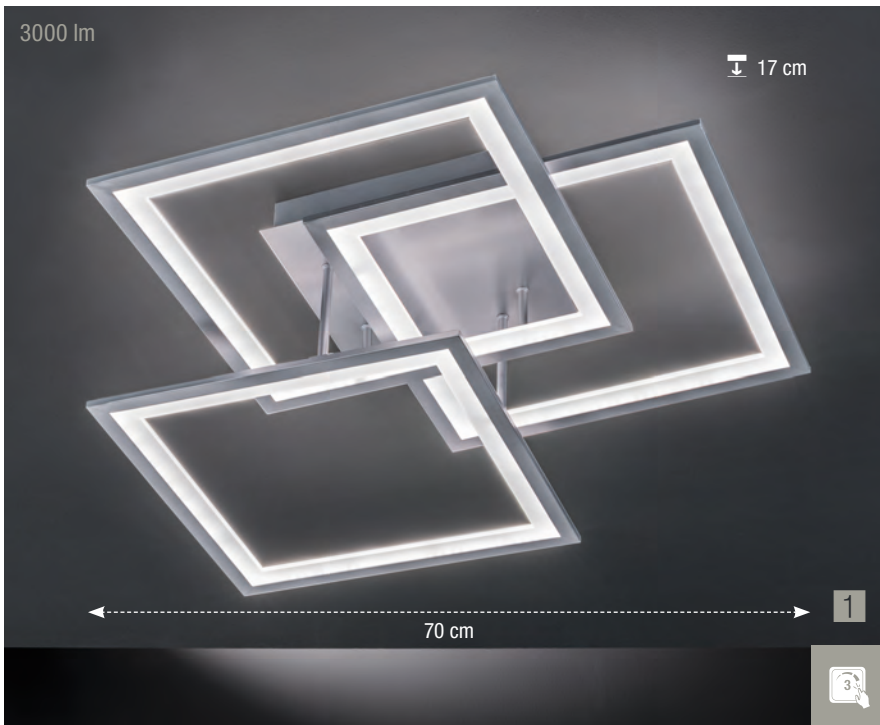

	Serie / Series	EAN-Nr. / EAN-No.	Material / Material	Leuchtmittel / Lamp	Kelvin / Kelvin	Lumen / Lumen	Glas / Glass	EEK / EEC
1	Viso 531 7531.03.64.8000	4003474347981	Nickel-matt / Nickel matt finished	LED / 45 W (incl.)	3000 K	3600 lm		
2	Viso 531 6531.03.64.8000	4003474349718	Nickel-matt / Nickel matt finished	LED / 87 W (incl.)	3000 K	6450 lm		
3	Viso 531 9531.03.64.8400	4003474347967	Nickel-matt / Nickel matt finished	LED / 88 W (incl.)	3000 K	6200 lm		



Serie / Series	EAN-Nr. / EAN-No.	Material / Material	Leuchtmittel / Lamp	Kelvin / Kelvin	Lumen / Lumen	Glas / Glass	EEK / EEC
1 VISO I 531 7531.04.64.8000	4003474348001	Nickel-matt / Nickel matt finished	LED / 55 W (incl.)	3000 K	4100 lm		
2 VISO I 531 6531.09.64.8000	4003474348070	Nickel-matt / Nickel matt finished	LED / 139 W (incl.)	3000 K	9300 lm		
3 VISO I 531 6531.04.64.8000	4003474347998	Nickel-matt / Nickel matt finished	LED / 55 W (incl.)	3000 K	4300 lm		





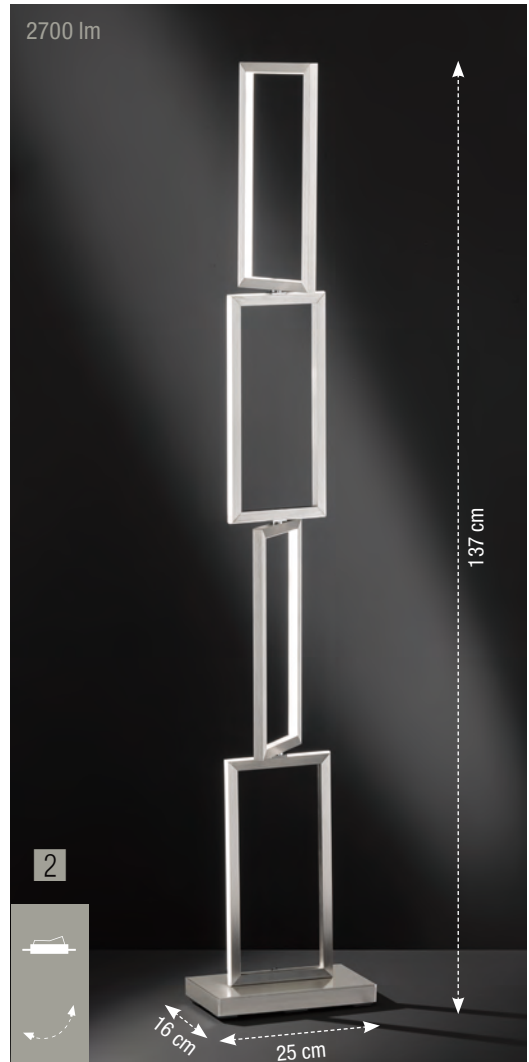

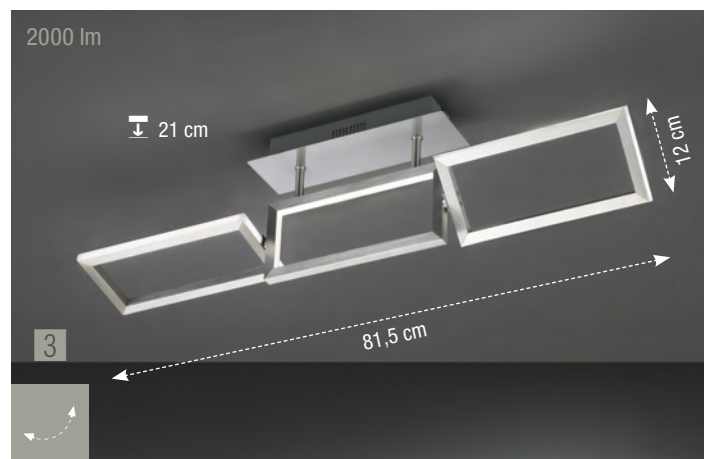
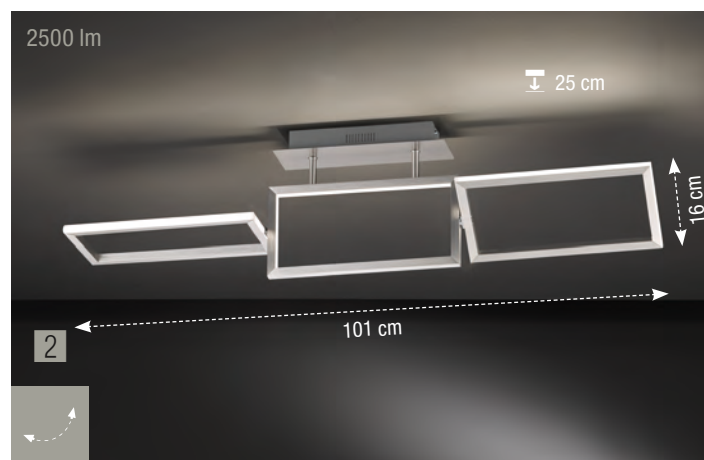
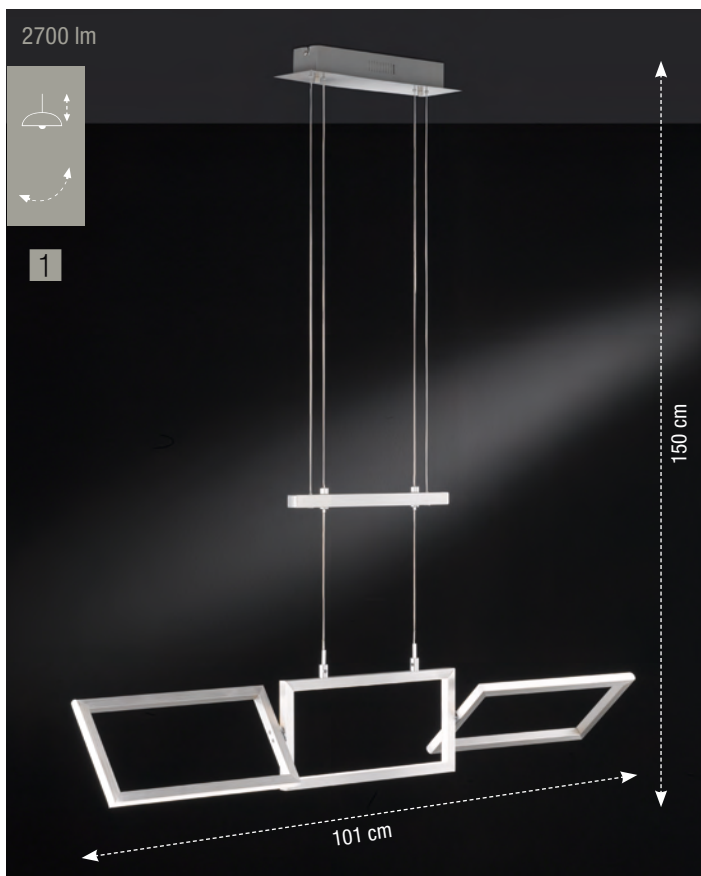

	Serie / Series	EAN-Nr. / EAN-No.	Material / Material	Leuchtmittel / Lamp	Kelvin / Kelvin	Lumen / Lumen	Glas / Glass	EEK / EEC
1	Modesto 243 9243.03.70.8400	4003474350905	Silber / Silver	 LED / 37 W (incl.)	3000 K	3000 lm		
2	Modesto 243 9243.03.44.8000	4003474351629	Multi Color / Multi Colour	 LED / 33 W (incl.)	3000 K	2500 lm		
3	Modesto 243 9243.03.70.8300	4003474350899	Silber / Silver	 LED / 33 W (incl.)	3000 K	2500 lm		





	Serie / Series	EAN-Nr. / EAN-No.	Material / Material	Leuchtmittel / Lamp	Kelvin / Kelvin	Lumen / Lumen	Glas / Glass	EEK / EEC
1	Skip I 159 7159.01.63.8000	4003474352954	Aluminium gebürstet / Aluminium brushed finished	1 x LED / 25 W (incl.)	3000 K	1 x 2100 lm		A
2	Skip I 159 3159.01.63.8000	4003474352947	Aluminium gebürstet / Aluminium brushed finished	1 x LED / 40 W (incl.)	3000 K	1 x 2700 lm		A
3	Skip I 159 8159.01.63.8000	4003474352978	Aluminium gebürstet / Aluminium brushed finished	1 x LED / 10 W (incl.)	3000 K	1 x 750 lm		A

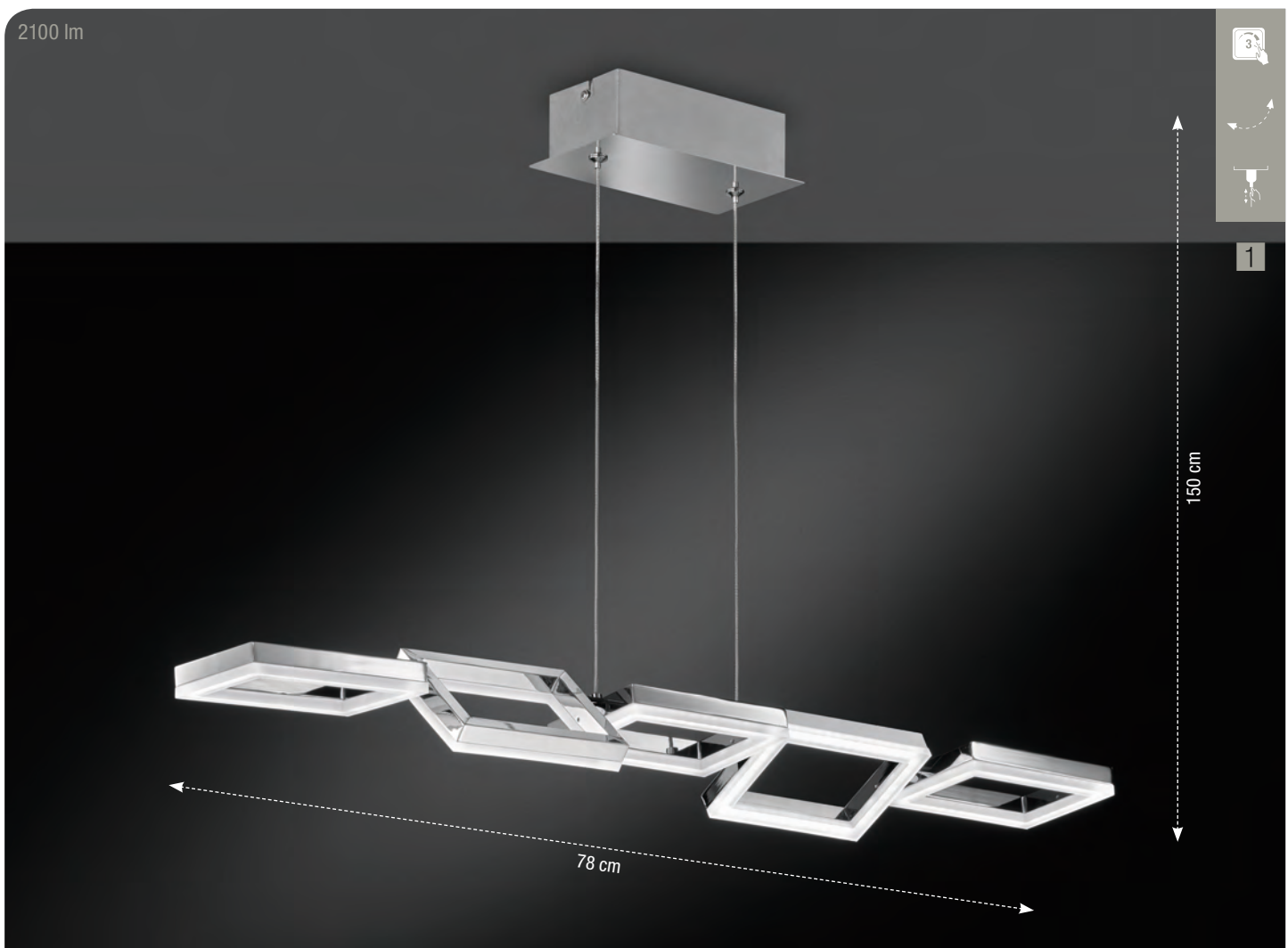

	Serie / Series	EAN-Nr. / EAN-No.	Material / Material	Leuchtmittel / Lamp	Kelvin / Kelvin	Lumen / Lumen	Glas / Glass	EEK / EEC
1	Skip I 159 7159.01.63.8100	4003474352961	Aluminium gebürstet / Aluminium brushed finished	 1 x LED / 32 W (incl.)	3000 K	1 x 2700 lm		
2	Skip I 159 9159.01.63.8100	4003474353005	Aluminium gebürstet / Aluminium brushed finished	 1 x LED / 32 W (incl.)	3000 K	1 x 2500 lm		
3	Skip I 159 9159.01.63.8000	4003474352985	Aluminium gebürstet / Aluminium brushed finished	 1 x LED / 26 W (incl.)	3000 K	1 x 2000 lm		





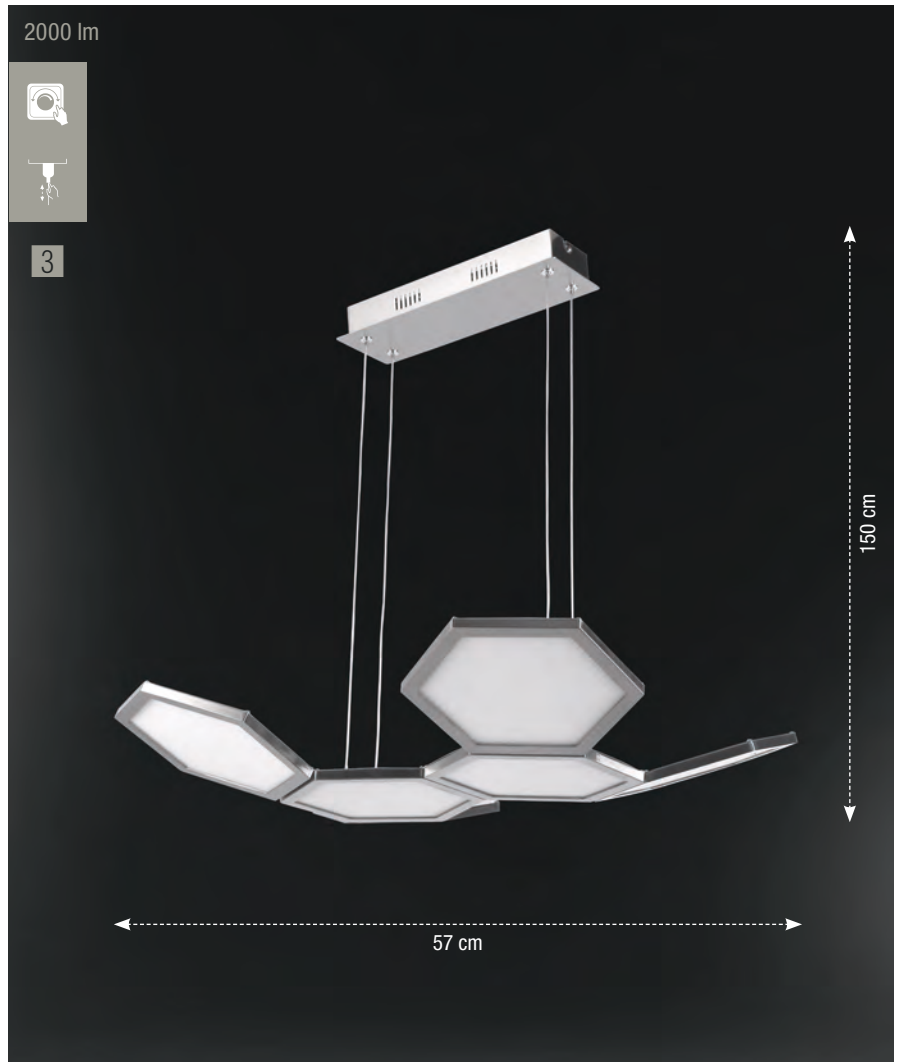
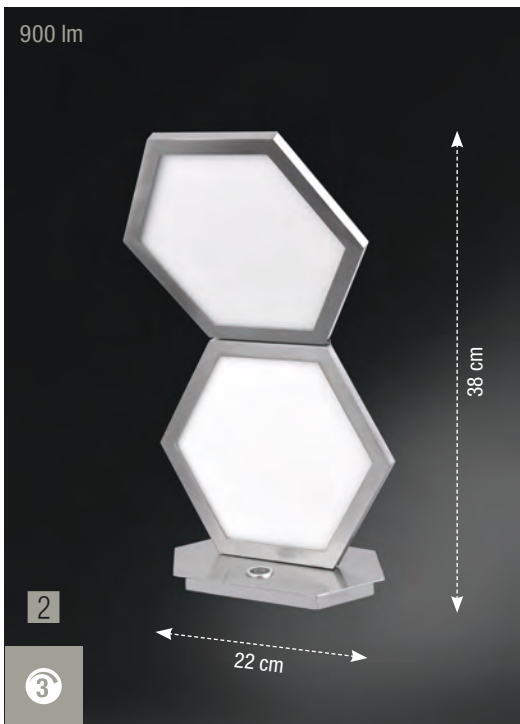
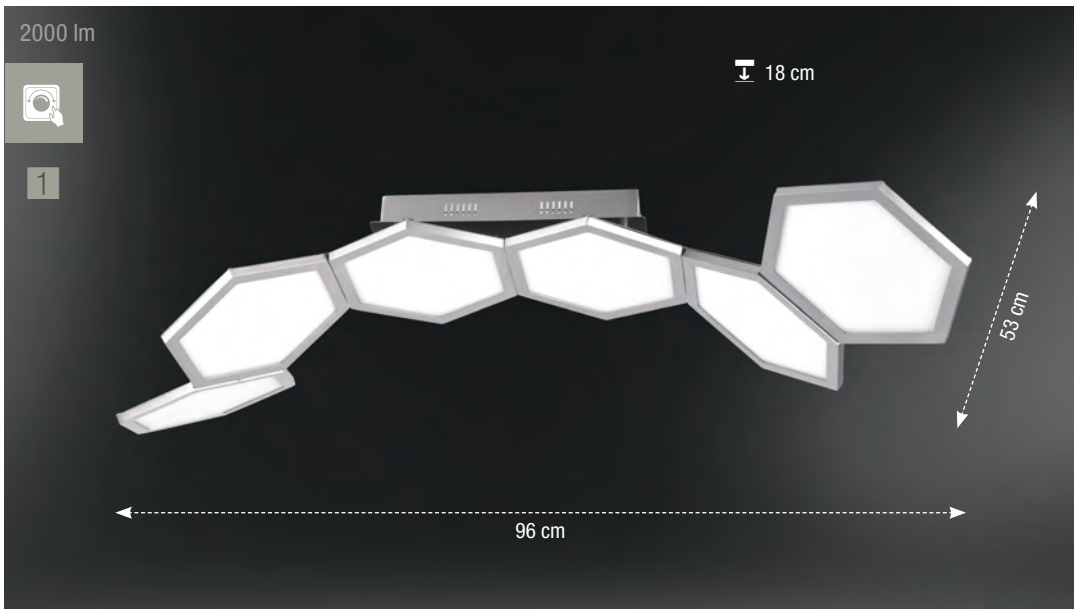

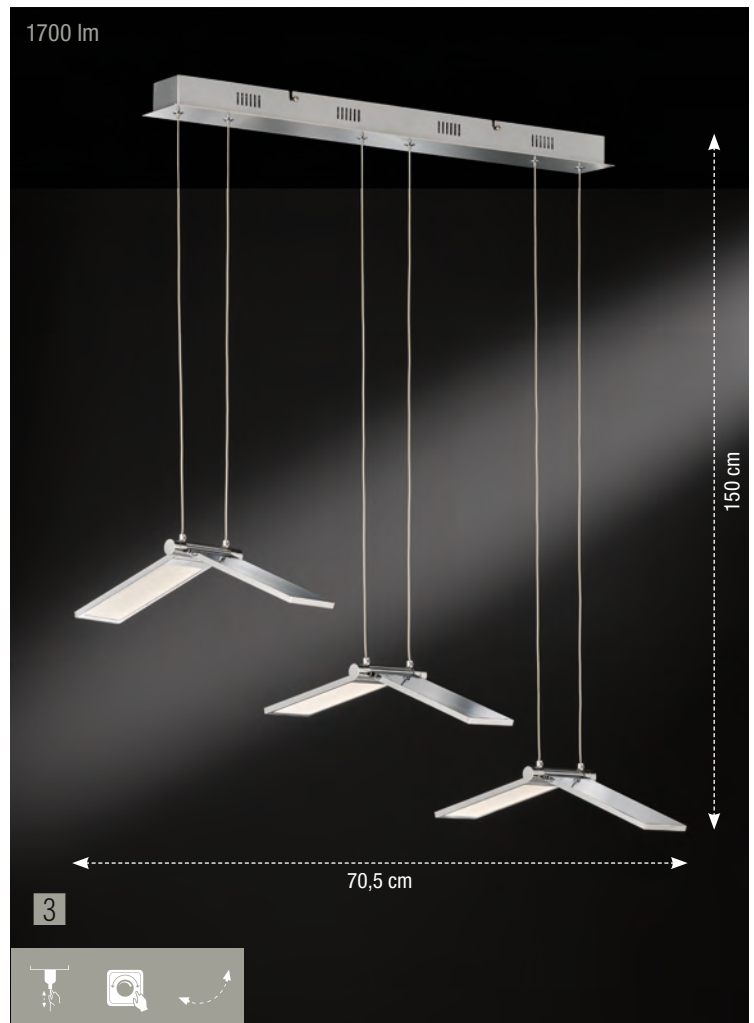

Serie / Series	EAN-Nr. / EAN-No.	Material / Material	Leuchtmittel / Lamp	Kelvin / Kelvin	Lumen / Lumen	Glas / Glass	EEK / EEC
1 Montreal 414 6414.05.64.8000	4003474351957	Nickel-matt / Nickel matt finished	 LED / 25 W (incl.)	3000 K	2100 lm		







Serie / Series	EAN-Nr. / EAN-No.	Material / Material	Leuchtmittel / Lamp	Kelvin / Kelvin	Lumen / Lumen	Glas / Glass	EEK / EEC
1 Signe I 323 9323.01.64.8000	4003474343518	Nickel-matt / Nickel matt finished	1 x LED / 26 W (incl.)	3000 K	1 x 2000 lm		A
2 Signe I 323 8323.01.64.8000	4003474343549	Nickel-matt / Nickel matt finished	1 x LED / 10 W (incl.)	3000 K	1 x 900 lm		A+
3 Signe I 323 6323.01.64.8000	4003474343532	Nickel-matt / Nickel matt finished	1 x LED / 26 W (incl.)	3000 K	1 x 2000 lm		A

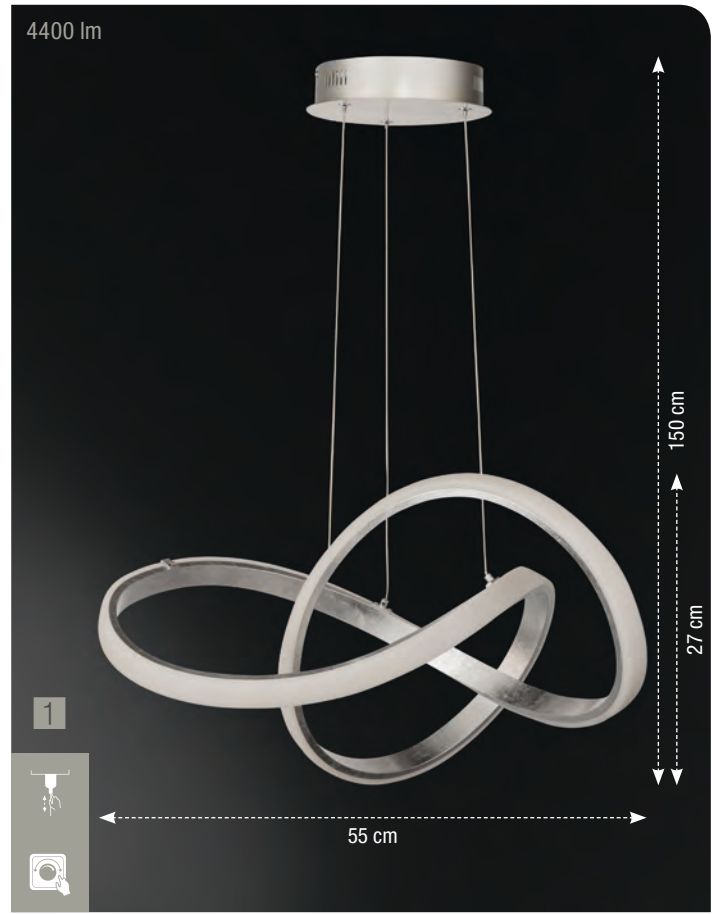





	Serie / Series	EAN-Nr. / EAN-No.	Material / Material	Leuchtmittel / Lamp	Kelvin / Kelvin	Lumen / Lumen	Glas / Glass	EEK / EEC
1	Livia 319 9319.01.64.8000	4003474351940	Nickel-matt / Nickel matt finished	 1 x LED / 26.5 W (incl.)	3000 K	1 x 1700 lm		
2	Livia 319 6319.01.64.8000	4003474351926	Nickel-matt / Nickel matt finished	 1 x LED / 26.5 W (incl.)	3000 K	1 x 1700 lm		
3	Livia 319 7319.03.64.8000	4003474351933	Nickel-matt / Nickel matt finished	 LED / 26.5 W (incl.)	3000 K	1700 lm		

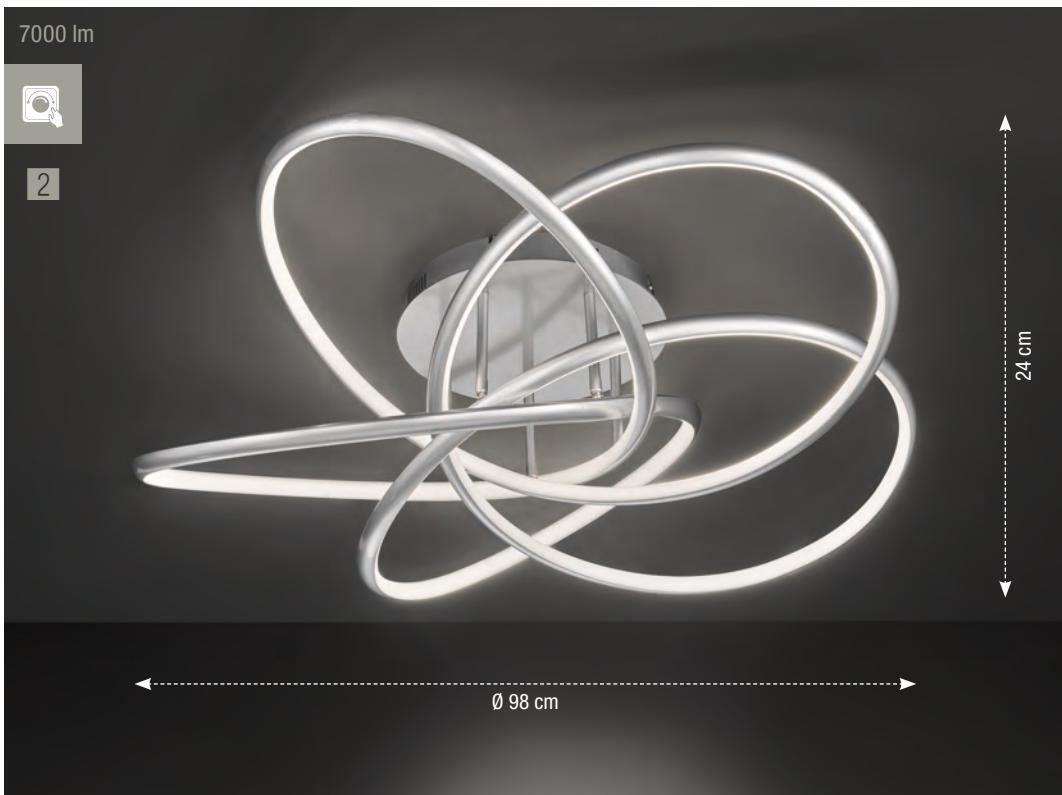
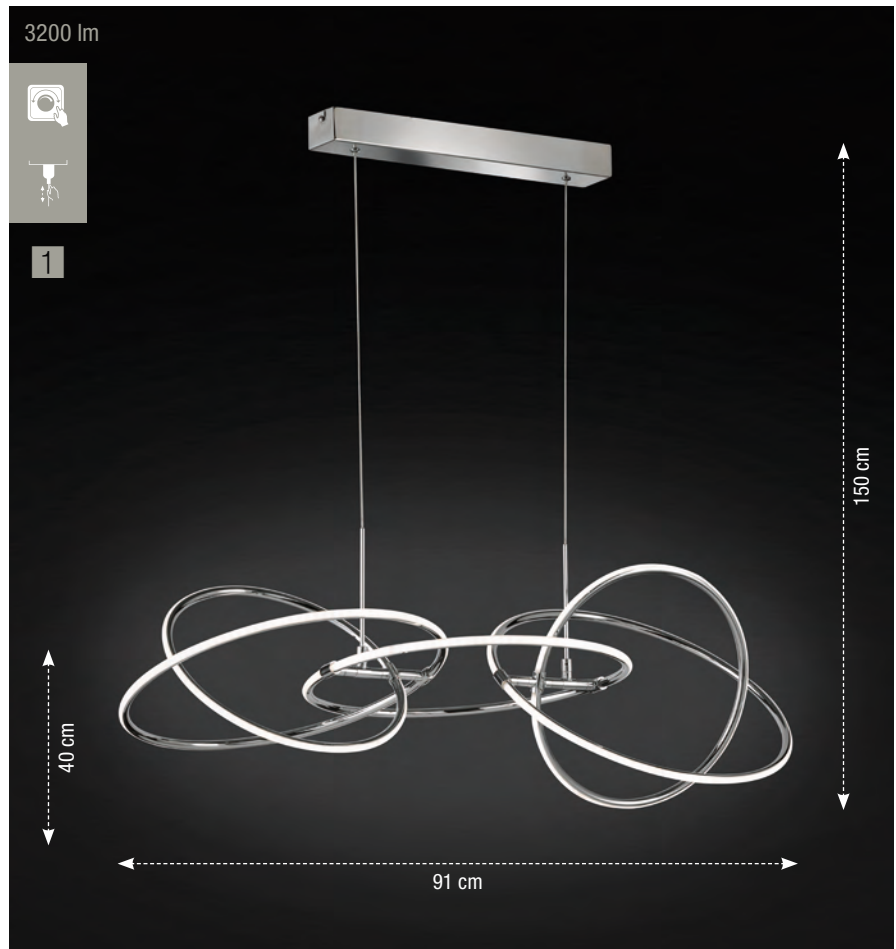

Serie / Series	EAN-Nr. / EAN-No.	Material / Material	Leuchtmittel / Lamp	Kelvin / Kelvin	Lumen / Lumen	Glas / Glass	EEK / EEC
1 Indigo 134 6134.01.70.8000	4003474346878	Silber / Silver	 1 x LED / 44 W (incl.)	3000 K	1 x 4400 lm		
2 Indigo 134 9134.01.70.8000	4003474349657	Silber / Silver	 1 x LED / 49 W (incl.)	3000 K	1 x 3900 lm		



Serie / Series	EAN-Nr. / EAN-No.	Material / Material	Leuchtmittel / Lamp	Kelvin / Kelvin	Lumen / Lumen	Glas / Glass	EEK / EEC
1 Spring 086 6086.01.01.8100	4003474342733	Chrom / Chrome	 1 x LED / 47 W (incl.)	3000 K	1 x 3200 lm		
2 Risa 170 9170.01.70.8000	4003474346915	Silber / Silver	 1 x LED / 98 W (incl.)	3000 K	1 x 7000 lm		

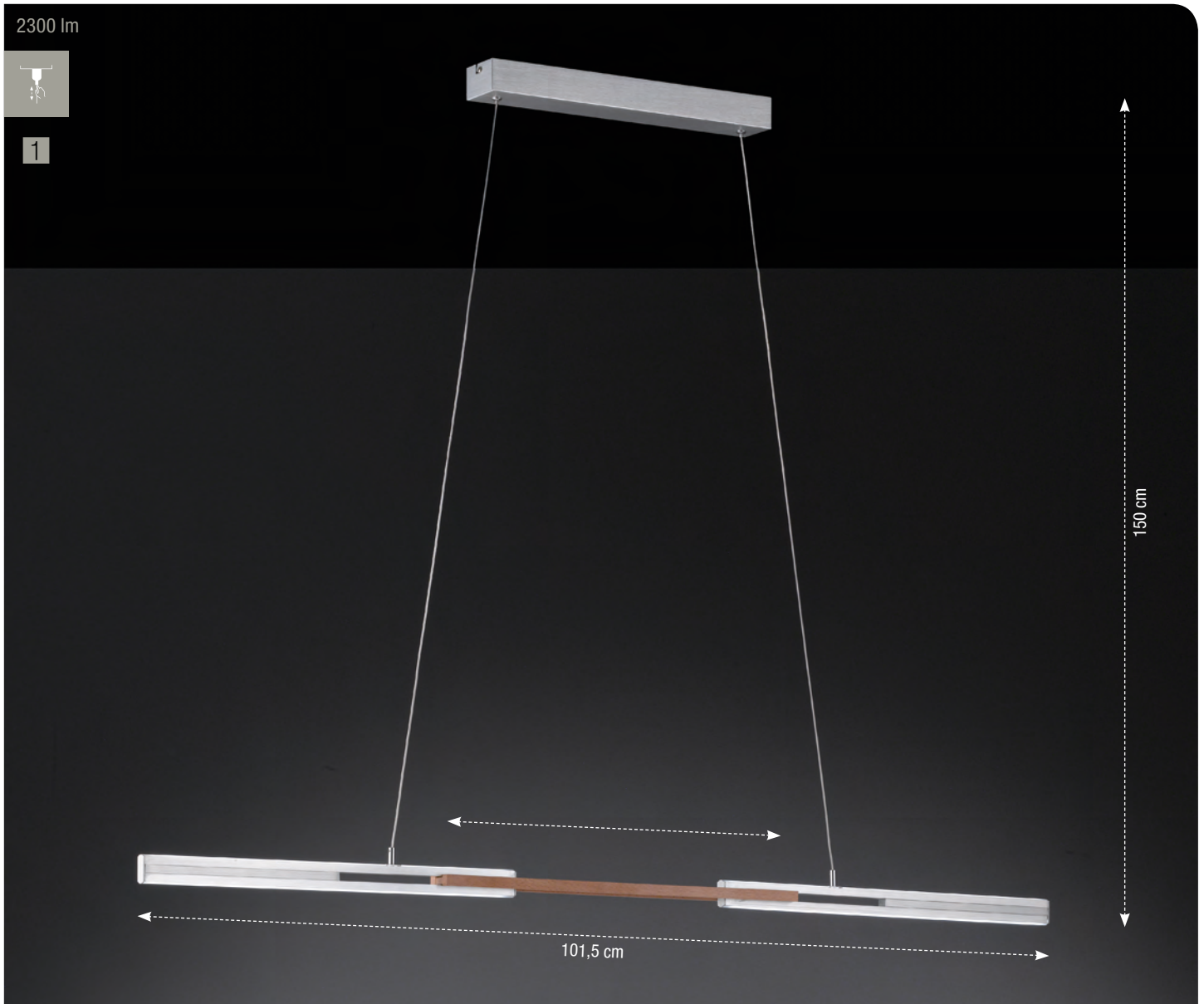

Serie / Series	EAN-Nr. / EAN-No.	Material / Material	Leuchtmittel / Lamp	Kelvin / Kelvin	Lumen / Lumen	Glas / Glass	EEK / EEC
1 Kit I 266 6266.01.63.8000	4003474347561	Aluminium gebürstet / Aluminium brushed finished	 1 x LED / 32 W (incl.)	3000 K	1 x 2300 lm		



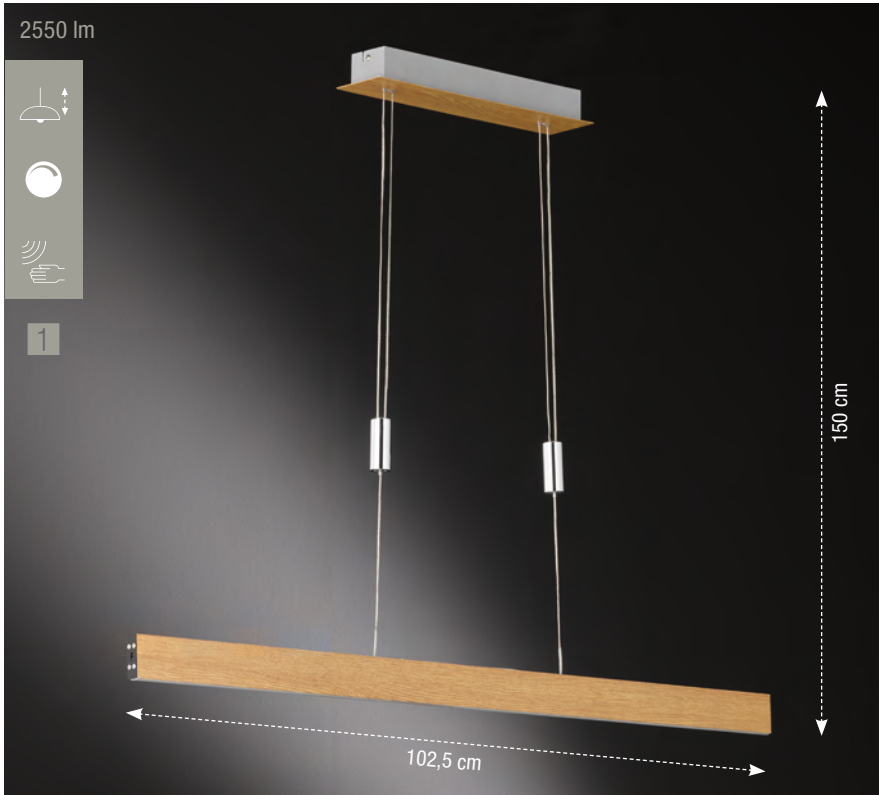

Serie / Series	EAN-Nr. / EAN-No.	Material / Material	Leuchtmittel / Lamp	Kelvin / Kelvin	Lumen / Lumen	Glas / Glass	EEK / EEC
1 Sydney 096 7096.01.51.8000	4003474350677	Holz / Wood	1 x LED / 31 W (incl.) LED Board	3000 K	1 x 2550 lm		A
2 Sydney 096 3096.01.51.8000	4003474350714	Holz / Wood	1 x LED / 35 W (incl.) LED Board	3000 K	1 x 2880 lm		A
3 Sydney 096 8096.01.51.8000	4003474350707	Holz / Wood	1 x LED / 13 W (incl.) LED Board	3000 K	1 x 1200 lm		A+



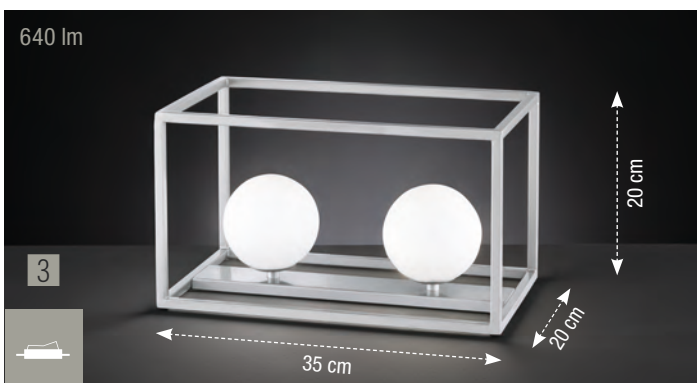
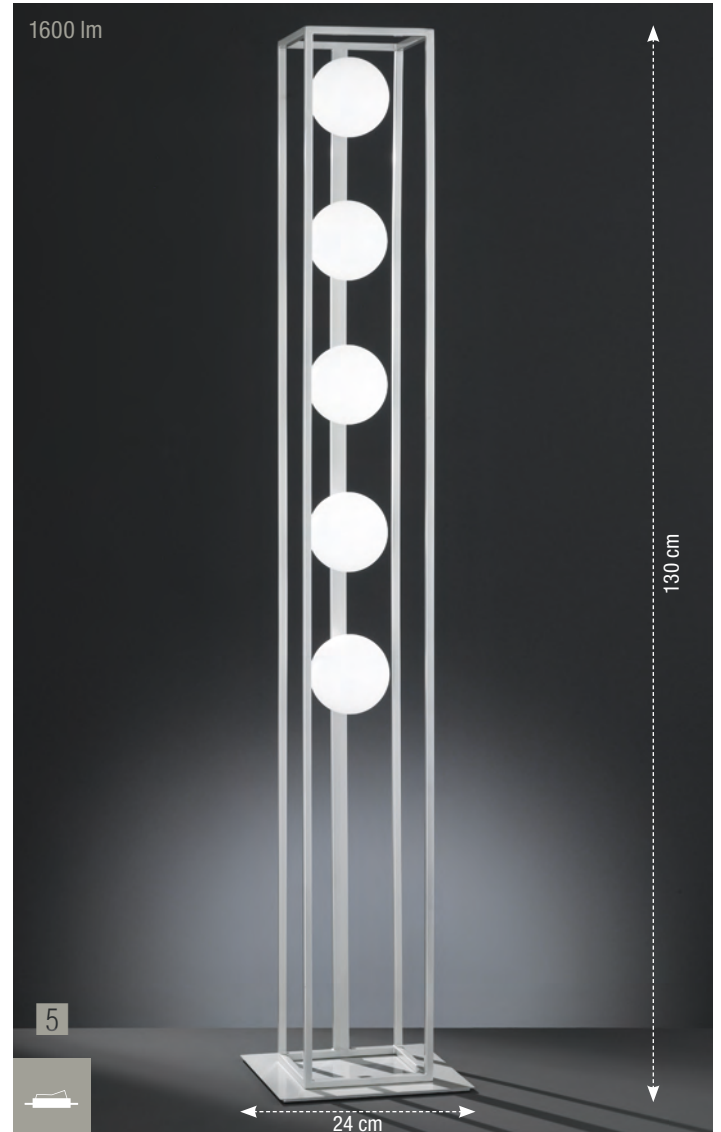
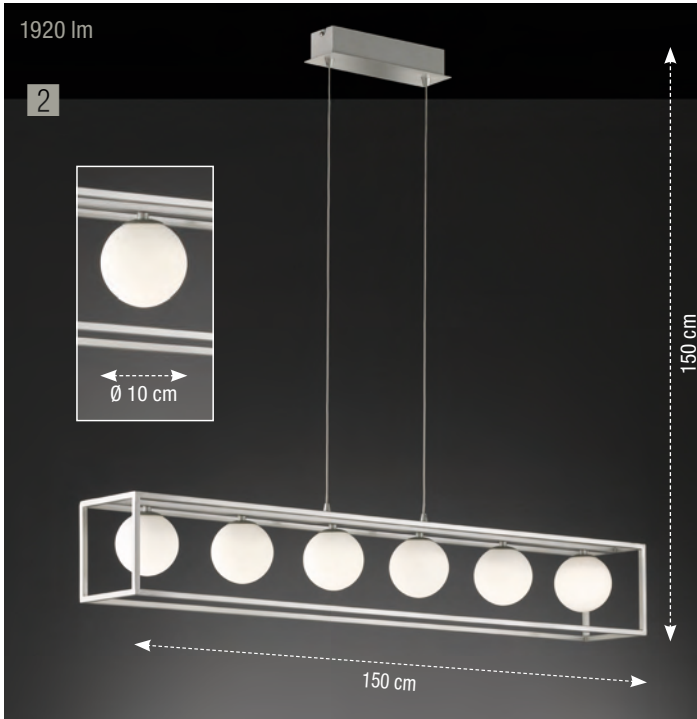
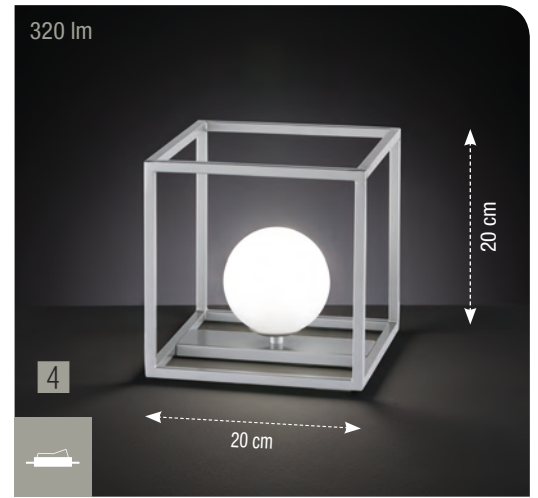
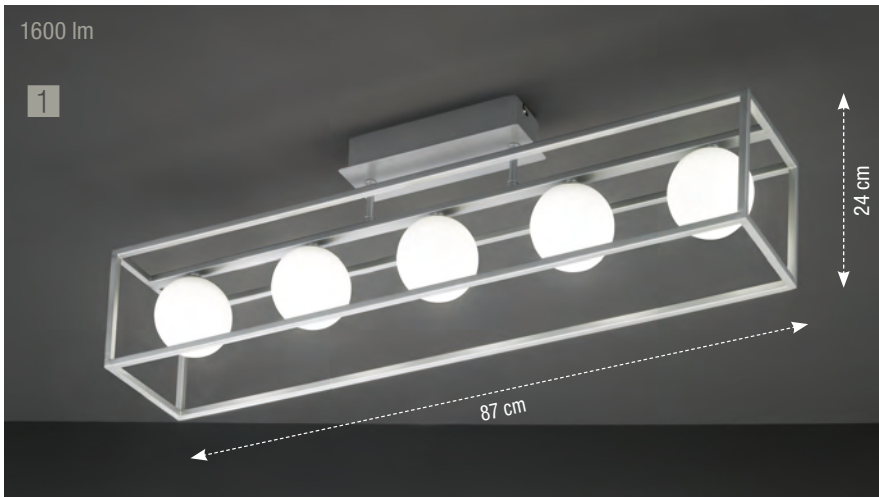

	Serie / Series	EAN-Nr. / EAN-No.	Material / Material	Leuchtmittel / Lamp	Kelvin / Kelvin	Lumen / Lumen	Glas / Glass	EEK / EEC
1	Aurelia 341 9341.05.64.8000	4003474346182	Nickel-matt / Nickel matt finished	5 x G9 LED 3.5 W (incl.)	3000 K	5 x 320 lm	3116	A+
2	Aurelia 341 7341.06.64.8000	4003474343884	Nickel-matt / Nickel matt finished	6 x G9 LED 3.5 W (incl.)	3000 K	6 x 320 lm	3116	A+
3	Aurelia 341 8341.02.64.8000	4003474343860	Nickel-matt / Nickel matt finished	2 x G9 LED 3.5 W (incl.)	3000 K	2 x 320 lm	3116	A+
4	Aurelia 341 8341.01.64.8000	4003474343853	Nickel-matt / Nickel matt finished	1 x G9 LED 3.5 W (incl.)	3000 K	1 x 320 lm	3116	A+
5	Aurelia 341 3341.05.64.8000	4003474346175	Nickel-matt / Nickel matt finished	5 x G9 LED 3.5 W (incl.)	3000 K	5 x 320 lm	3116	A+



Why
HELLO

LOVE

Spiel mit Reflexionen

Ob modern, verspielt oder glamourös: Kristall-Leuchten sind luxuriöses Wohnelement und schöne Beleuchtung in einem. Mit unseren exklusiven Modellen haben wir den Kronleuchter von damals neu interpretiert. Damit Sie jeden Tag zauberhafte Lichtspiele genießen können.

Playing with reflections





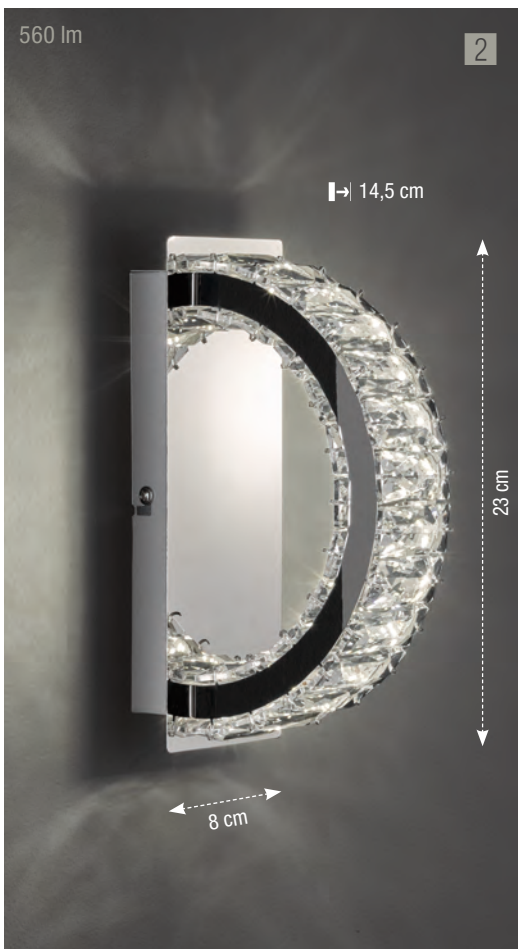

Modern, playful or luxurious: crystal chandeliers provide a luxurious ambience and beautiful lighting. Our exclusive models reinterpret yesterday's chandelier so you can enjoy magical light effects every day.

ANESA | Seite 38 - 39





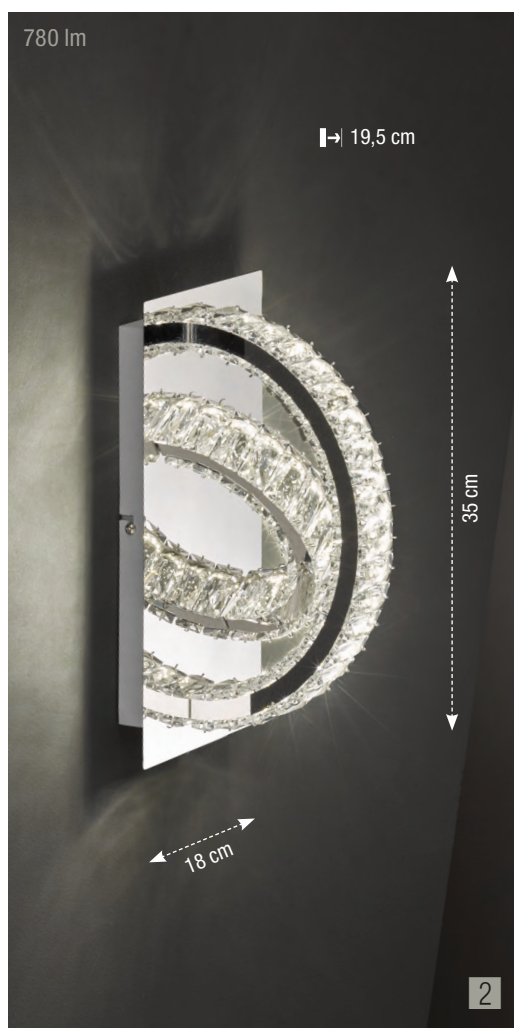
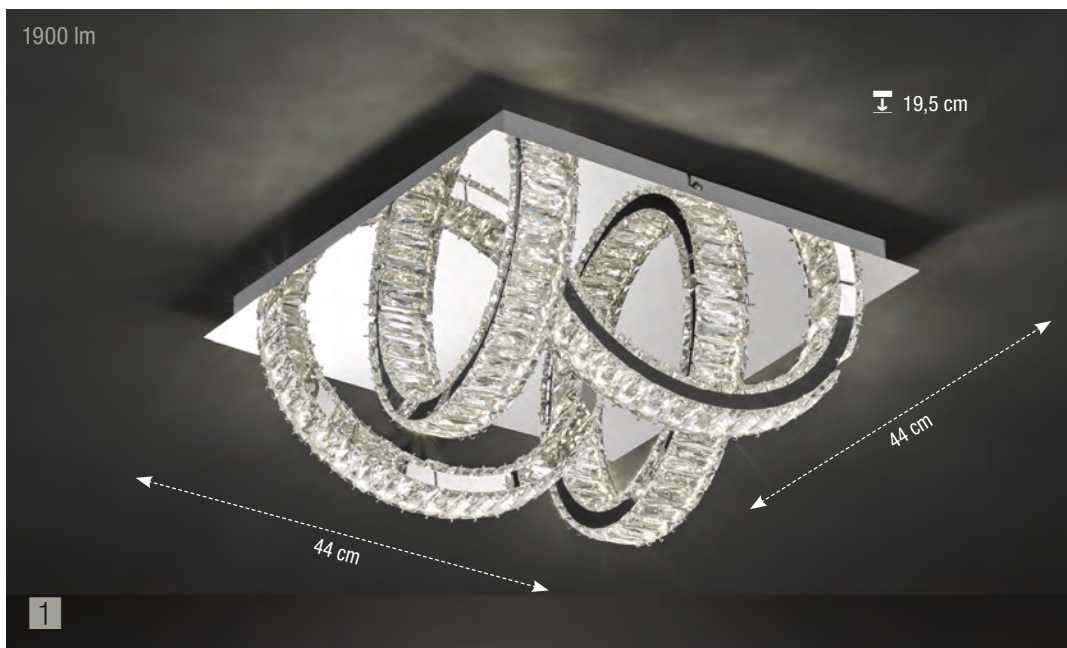

MEDLEY | Seite 40

GINO | Seite 41







	Serie / Series	EAN-Nr. / EAN-No.	Material / Material	Leuchtmittel / Lamp	Kelvin / Kelvin	Lumen / Lumen	Glas / Glass	EEK / EEC
1	Anesa 293 9293.04.01.8100	4003474351438	Chrom / Chrome	 LED / 26 W (incl.)	3000 K	1900 lm		
2	Anesa 293 4293.01.01.8000	4003474347783	Chrom / Chrome	 LED / 6 W (incl.)	3000 K	560 lm		
3	Anesa 293 6293.03.01.8000	4003474347813	Chrom / Chrome	 LED / 16 W (incl.)	3000 K	1600 lm		





	Serie / Series	EAN-Nr. / EAN-No.	Material / Material	Leuchtmittel / Lamp	Kelvin / Kelvin	Lumen / Lumen	Glas / Glass	EEK / EEC
1	Anesa 293 9293.04.01.8000	4003474351421	Chrom / Chrome	 LED / 20.5 W (incl.)	3000 K	1900 lm		
2	Anesa 293 4293.02.01.8000	4003474347790	Chrom / Chrome	 LED / 8 W (incl.)	3000 K	780 lm		
3	Anesa 293 4293.03.01.8000	4003474347806	Chrom / Chrome	 LED / 11 W (incl.)	3000 K	1050 lm		



Serie / Series	EAN-Nr. / EAN-No.	Material / Material	Leuchtmittel / Lamp	Kelvin / Kelvin	Lumen / Lumen	Glas / Glass	EEK / EEC
1 Medley I 103 9103.01.01.8460	4003474350790	Chrom / Chrome	 1 x LED / 46 W (incl.)	3000 K	1 x 3100 lm		
2 Medley I 103 9103.01.01.8420	4003474350806	Chrom / Chrome	 1 x LED / 37 W (incl.)	3000 K	1 x 2500 lm		



	Serie / Series	EAN-Nr. / EAN-No.	Material / Material	Leuchtmittel / Lamp	Kelvin / Kelvin	Lumen / Lumen	Glas / Glass	Eek / EEC
1	Gino I 359 6359.01.01.8300	4003474348797	Chrom / Chrome	 1 x LED / 17 W (incl.)	3000 K	1 x 1500 lm		A ⁺
2	Gino I 359 6359.01.01.8400	4003474348803	Chrom / Chrome	 1 x LED / 28 W (incl.)	3000 K	1 x 2200 lm		A
3	Gino I 359 8359.01.01.8250	4003474348810	Chrom / Chrome	 1 x LED / 18 W (incl.)	3000 K	1 x 1500 lm		A ⁺



LIVE
A DREAMER LIVES FOREVER
LOVE
EVERYTHING GROWS WITH LOVE
LAUGH
LAUGH WITH YOUR HEART

&

Retro

Retro

Die Liebe zum Style vergangener Tage

Retro ist zur Zeit ein allseits beliebter Stil. Immer mehr Menschen berufen sich auf den Geschmack vergangener Zeiten. Lassen Sie sich inspirieren.

Passion for the style of the good old days

Retro is currently a popular trending style.

More and more people are inspired by the taste of the past.

Let yourself be inspired

MIA | Seite 44 - 45

GRACE | Seite 44, 46

RONDA | Seite 47

CARMONA | Seite 48

TANDIL | Seite 49

YORK | Seite 50 - 51

SARA | Seite 52 - 53

DINA | Seite 54 - 55

AVERY | Seite 56

VERRE | Seite 56

ERIN | Seite 57

VANN | Seite 57

ANUR | Seite 57

MAYRA | Seite 58

VALENCIA | Seite 58

DYLAN | Seite 59

LENOX | Seite 60

CARAT | Seite 60

CESENA | Seite 61

MIA | Serie 166

GRACE | Serie 164





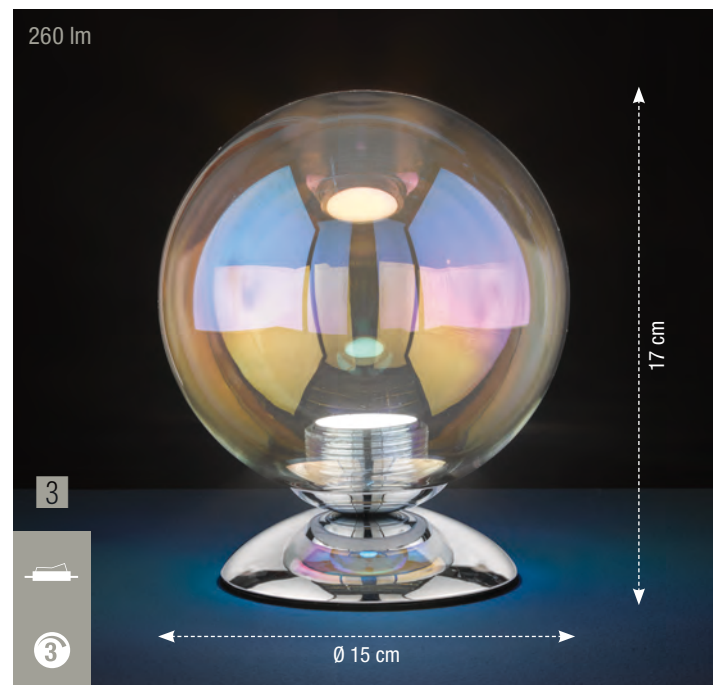
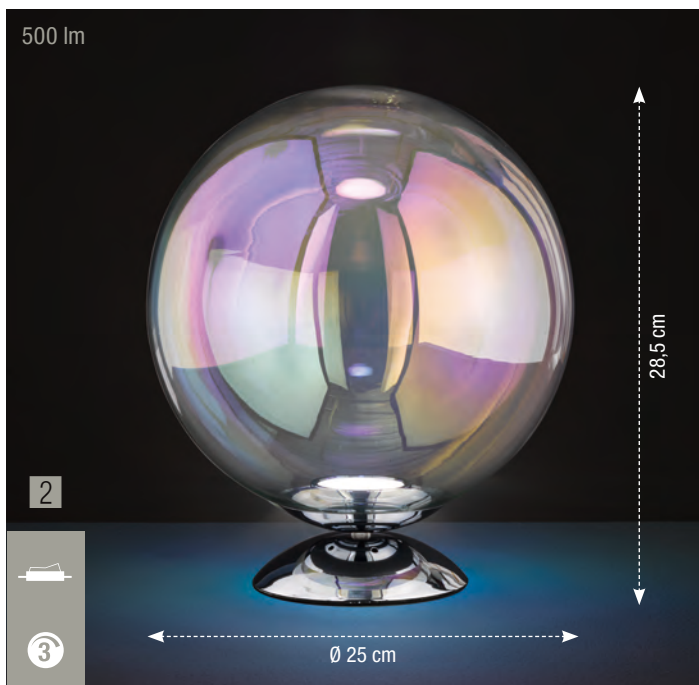
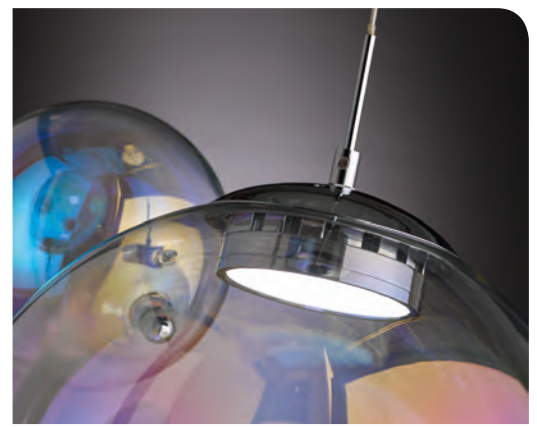

LED LIGHT by
WOFI®

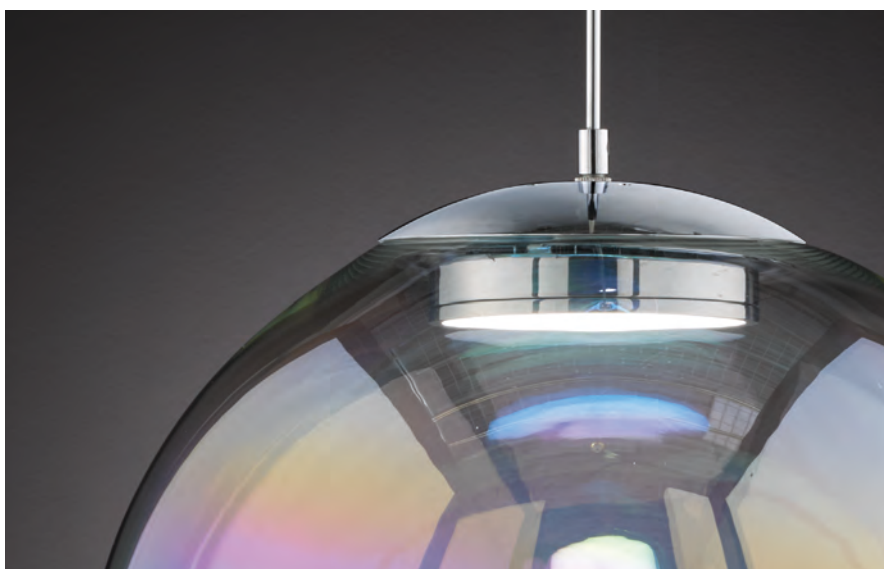
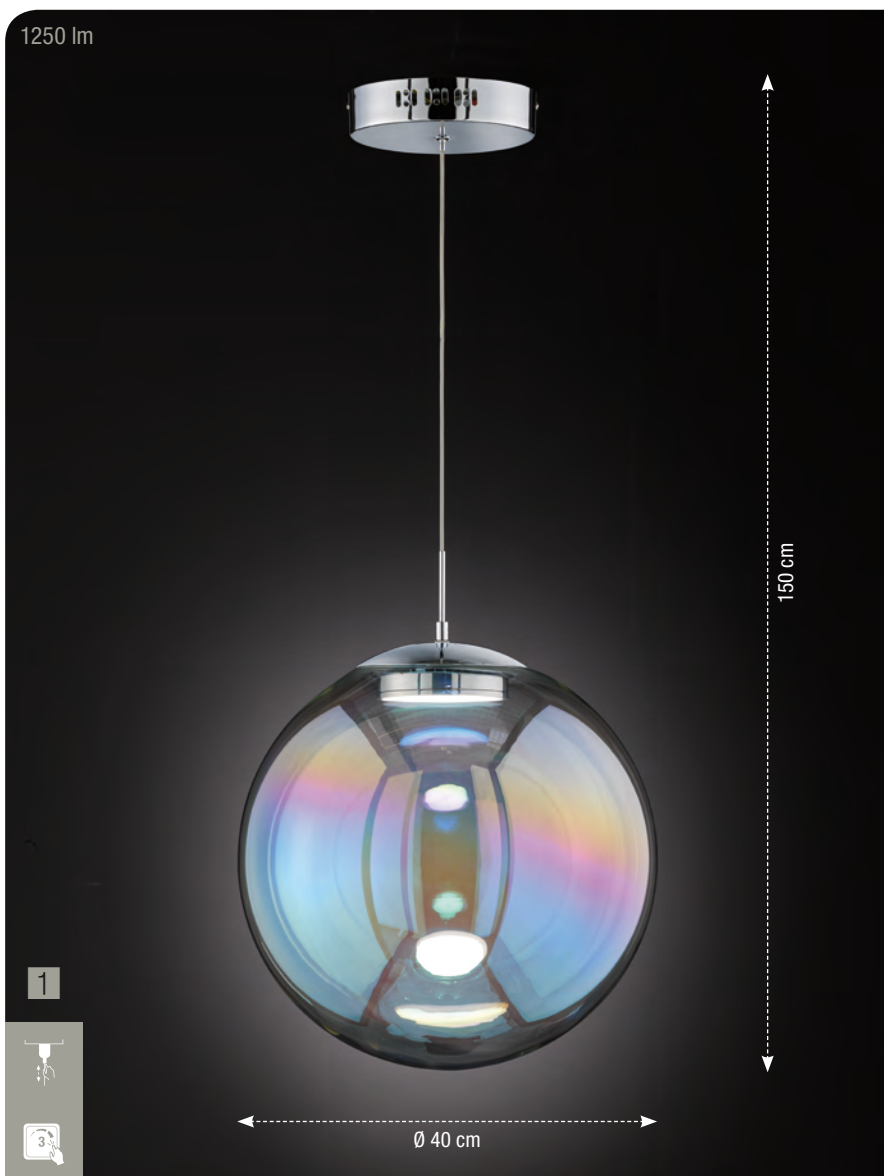

	Serie / Series	EAN-Nr. / EAN-No.	Material / Material	Leuchtmittel / Lamp	Kelvin / Kelvin	Lumen / Lumen	Glas / Glass	Eek / EEC
1	Mia I 166 6166.04.01.8000	4003474346885	Chrom / Chrome	LED / 8,5 W (incl.)	3000 K	750 lm	3141 3143 3144	A+
2	Mia I 166 8166.01.01.8250	4003474346854	Chrom / Chrome	1 x LED / 7 W (incl.)	3000 K	1 x 500 lm	3146	A
3	Mia I 166 8166.01.01.8150	4003474346861	Chrom / Chrome	1 x LED / 4 W (incl.)	3000 K	1 x 260 lm	3145	A+



	Serie / Series	EAN-Nr. / EAN-No.	Material / Material	Leuchtmittel / Lamp	Kelvin / Kelvin	Lumen / Lumen	Glas / Glass	EEK / EEC
1	Grace I 164 6164.01.01.8400	4003474346830	Chrom / Chrome	 1 x LED / 14 W (incl.)	3000 K	1 x 1250 lm	3140	A+ 
2	Grace I 164 6164.01.01.8300	4003474346847	Chrom / Chrome	 1 x LED / 8.5 W (incl.)	3000 K	1 x 750 lm	3139	A+ 

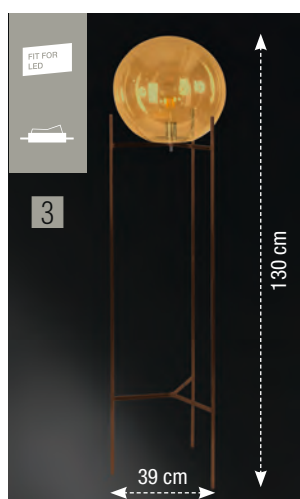

Serie / Series	EAN-Nr. / EAN-No.	Material / Material	Leuchtmittel / Lamp	Kelvin / Kelvin	Lumen / Lumen	Glas / Glass	EEK / EEC
1 Ronda 539 3539.01.01.8000	4003474344317	Chrom / Chrome	1 x E27 / max. 40 W			3148	A++ E
2 Ronda 539 8539.01.09.8000	4003474344324	Antik braun / Antique brown	1 x E27 / max. 40 W			3151	A++ E
3 Ronda 539 3539.01.09.8000	4003474344300	Antik braun / Antique brown	1 x E27 / max. 40 W			3149	A++ E
4 Ronda 539 8539.01.01.8000	4003474344331	Chrom / Chrome	1 x E27 / max. 40 W			3150	A++ E



Serie / Series	EAN-Nr. / EAN-No.	Material / Material	Leuchtmittel / Lamp	Kelvin / Kelvin	Lumen / Lumen	Glas / Glass	EEK / EEC
1 Carmona 445 6445.12.09.8000	4003474345420	Antik braun / Antique brown	12 x E27 / max. 25 W				
2 Carmona 445 6445.06.09.8000	4003474344102	Antik braun / Antique brown	6 x E27 / max. 25 W				



Serie / Series	EAN-Nr. / EAN-No.	Material / Material	Leuchtmittel / Lamp	Kelvin / Kelvin	Lumen / Lumen	Glas / Glass	EEK / EEC
1 Tanil 565 9565.06.46.8200	4003474344577	Schwarz gold / Black gold	6 x E27 / max. 60 W				A++ E
2 Tanil 565 9565.06.46.8100	4003474344560	Schwarz gold / Black gold	6 x E27 / max. 60 W				A++ E
3 Tanil 565 9565.04.46.8000	4003474344584	Schwarz gold / Black gold	4 x E27 / max. 60 W				A++ E

YORK | Serie 255

TANIL | Serie 565



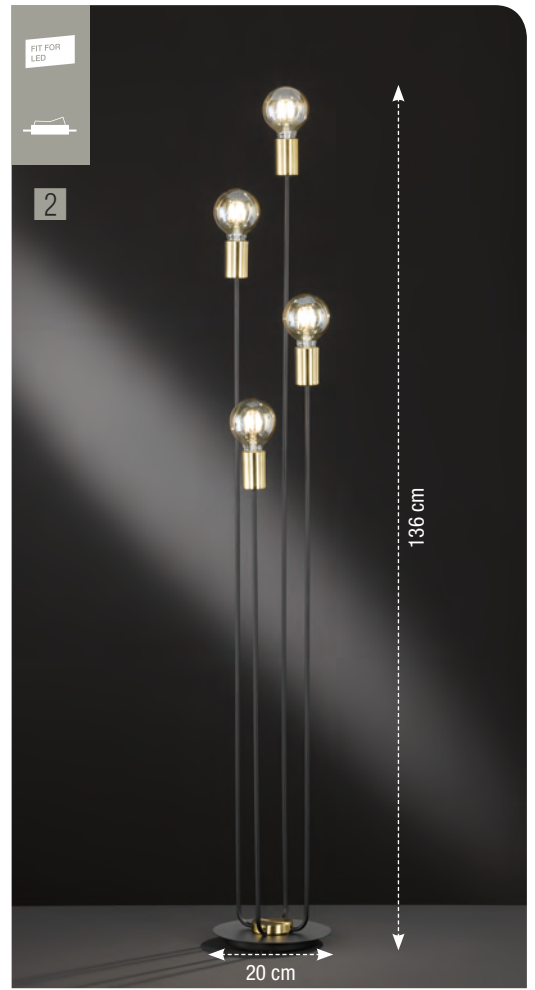



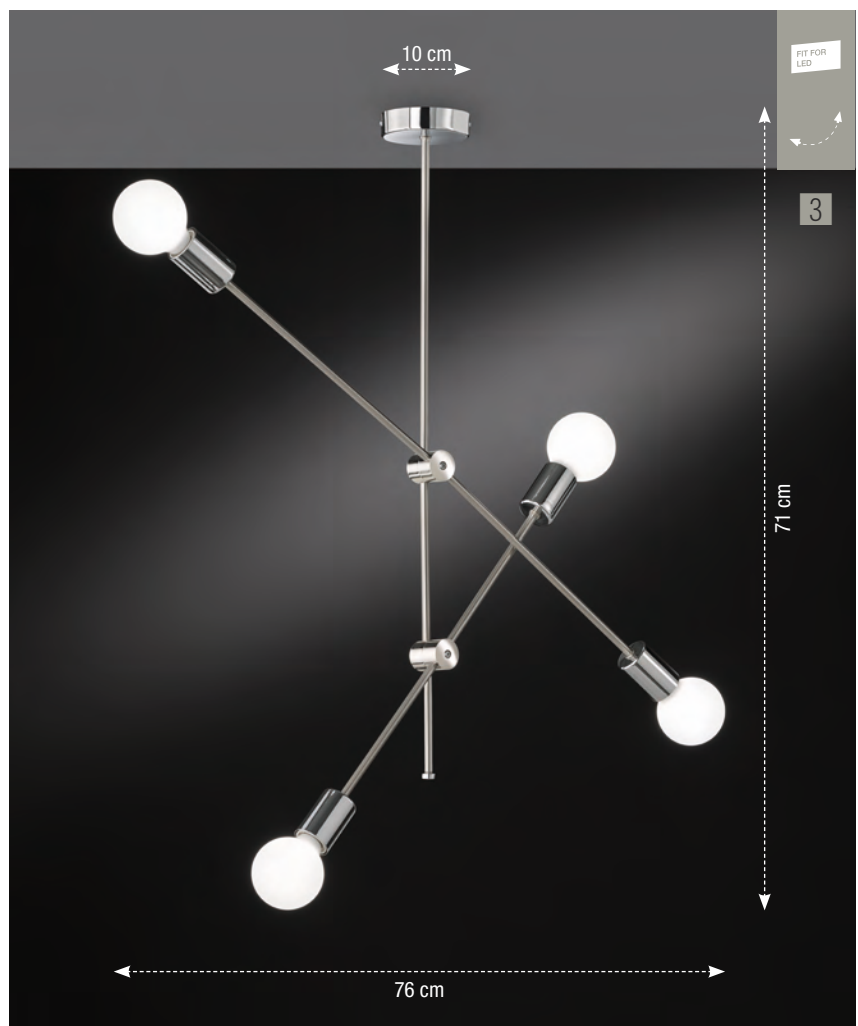
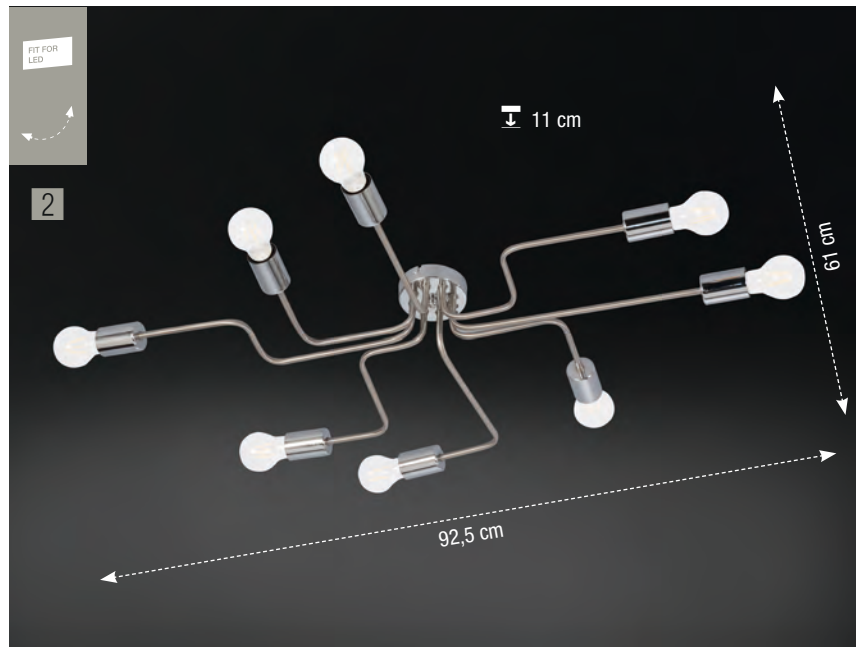
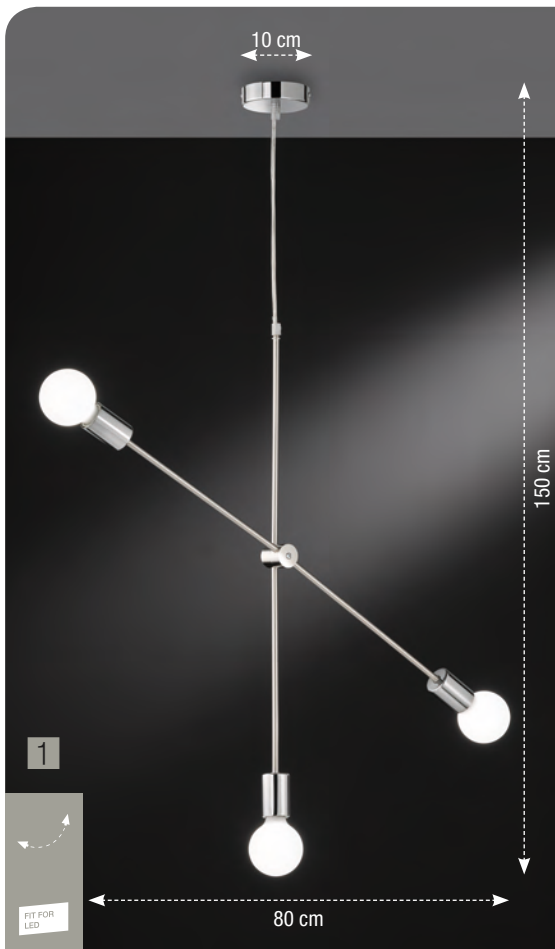

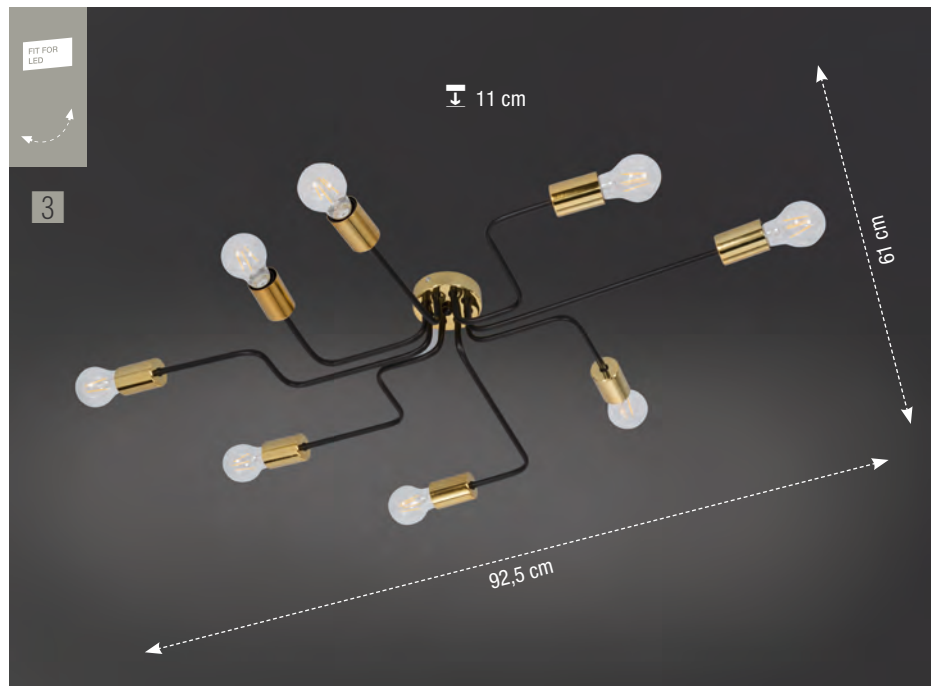

Serie / Series	EAN-Nr. / EAN-No.	Material / Material	Leuchtmittel / Lamp	Kelvin / Kelvin	Lumen / Lumen	Glas / Glass	EEK / EEC
1 York 255 9255.05.10.8000	4003474347479	Schwarz / Black	5 x E27 / max. 60 W				
2 York 255 3255.04.10.8000	4003474347462	Schwarz / Black	4 x E27 / max. 60 W				
3 York 255 8255.02.10.8000	4003474347455	Schwarz / Black	2 x E27 / max. 60 W				



	Serie / Series	EAN-Nr. / EAN-No.	Material / Material	Leuchtmittel / Lamp	Kelvin / Kelvin	Lumen / Lumen	Glas / Glass	EEK / EEC
1	Sara 365 6365.03.54.8000	4003474348988	Nickel-matt/Chrom / Nickel matt finished/Chrome	3 x E27 / max. 60 W				
2	Sara 365 9365.08.54.8000	4003474348940	Nickel-matt/Chrom / Nickel matt finished/Chrome	8 x E27 / max. 60 W				
3	Sara 365 6365.04.54.8000	4003474349824	Nickel-matt/Chrom / Nickel matt finished/Chrome	4 x E27 / max. 60 W				



Serie / Series	EAN-Nr. / EAN-No.	Material / Material	Leuchtmittel / Lamp	Kelvin / Kelvin	Lumen / Lumen	Glas / Glass	EEK / EEC
1 Sara 365 6365.03.46.8000	4003474348971	Schwarz gold / Black gold	 3 x E27 / max. 60 W				
2 Sara 365 6365.04.46.8000	4003474349817	Schwarz gold / Black gold	 4 x E27 / max. 60 W				
3 Sara 365 9365.08.46.8000	4003474348933	Schwarz gold / Black gold	 8 x E27 / max. 60 W				



LED LIGHT by
WOFI®

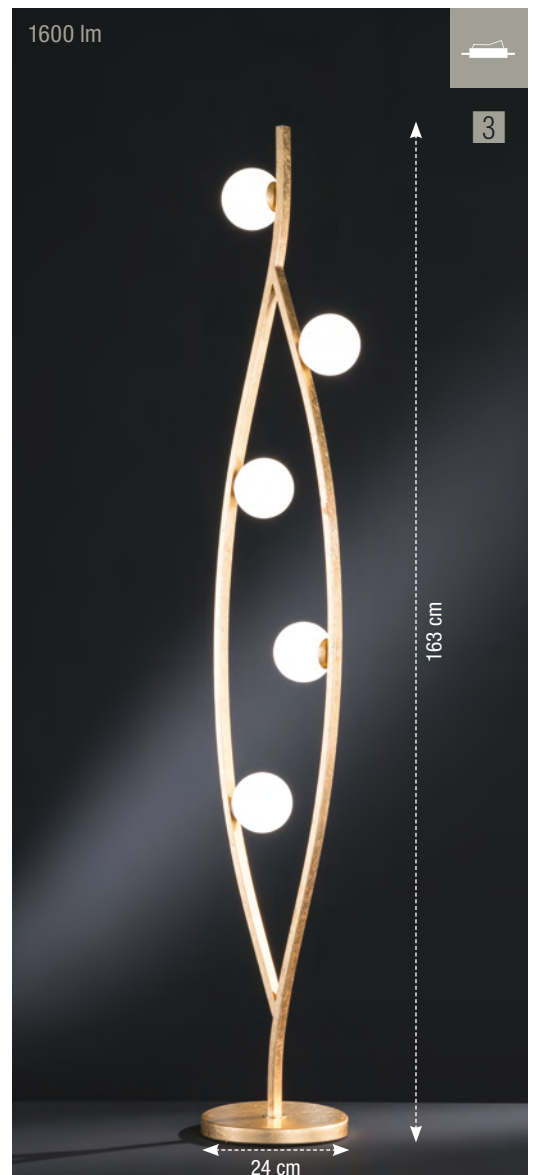
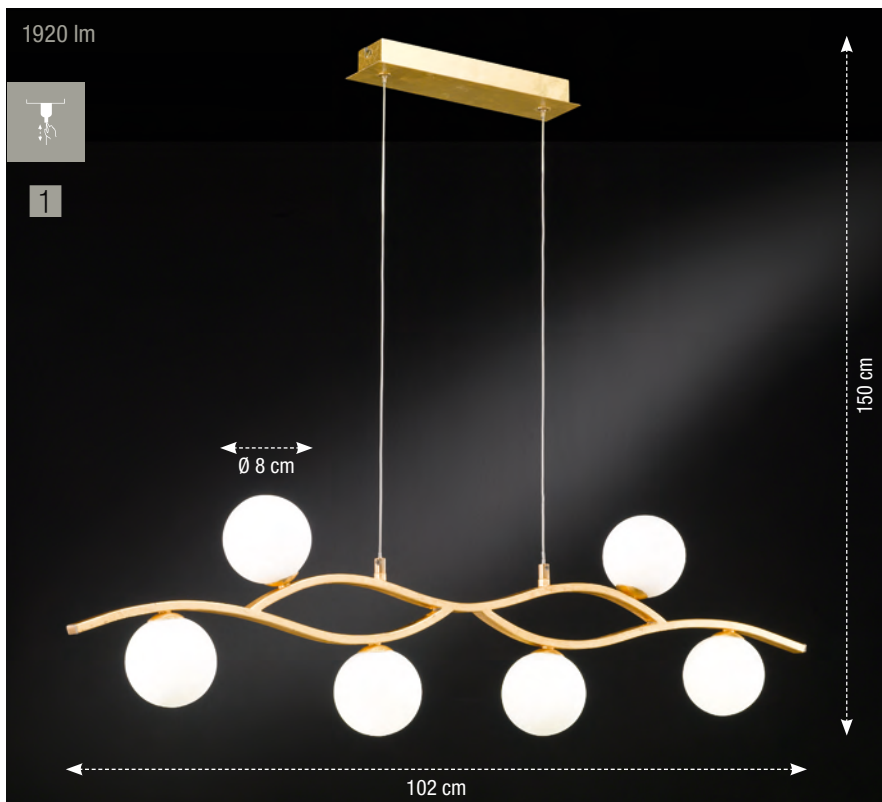

Serie / Series	EAN-Nr. / EAN-No.	Material / Material	Leuchtmittel / Lamp	Kelvin / Kelvin	Lumen / Lumen	Glas / Glass	EEK / EEC
1 Dina 185 6185.06.15.8000	4003474343150	Goldfarbig / Gold coloured	6 x G9 LED/ 3,5 W (incl.)	3000 K	6 x 320 lm	5156	A+
2 Dina 185 8185.03.15.8000	4003474343136	Goldfarbig / Gold coloured	3 x G9 LED/ 3,5 W (incl.)	3000 K	3 x 320 lm	5157	A+
3 Dina 185 3185.05.15.8000	4003474343167	Goldfarbig / Gold coloured	5 x G9 LED/ 3,5 W (incl.)	3000 K	5 x 320 lm	5156	A+

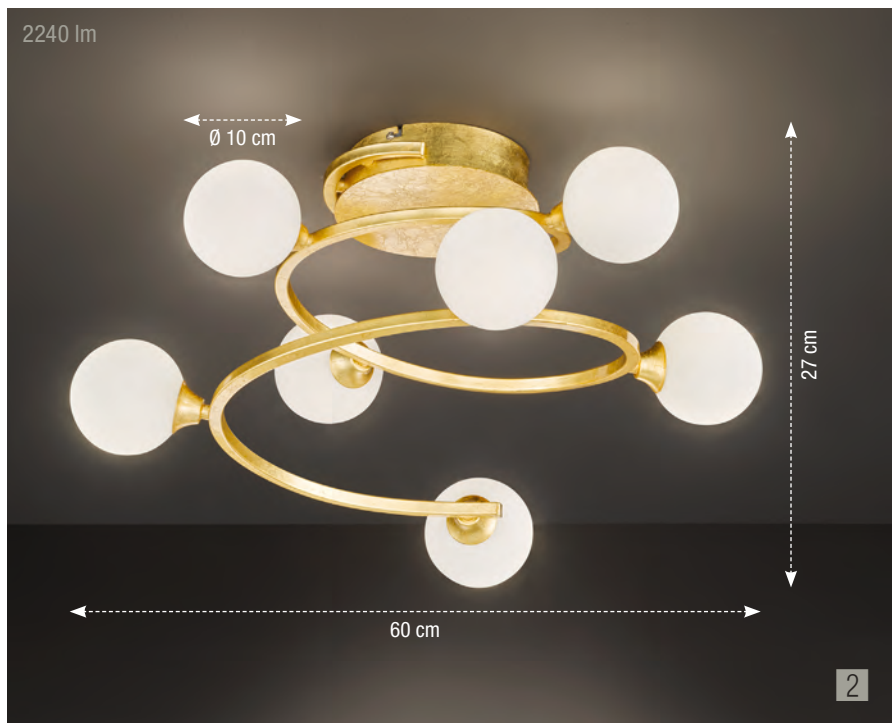
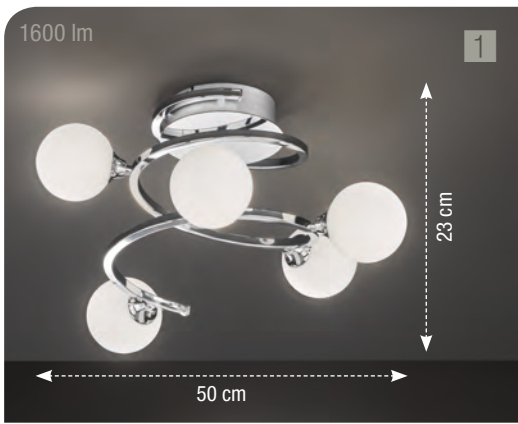

Serie / Series	EAN-Nr. / EAN-No.	Material / Material	Leuchtmittel / Lamp	Kelvin / Kelvin	Lumen / Lumen	Glas / Glass	EEK / EEC
1 Avery 188 9188.05.01.8000	4003474347080	Chrom / Chrome	5 x G9 LED / 3,5 W (incl.)	3000 K	5 x 320 lm	3116	A+
2 Avery 188 9188.07.15.8000	4003474347110	Goldfarbig / Gold coloured	7 x G9 LED / 3,5 W (incl.)	3000 K	7 x 320 lm	3116	A+
3 Verre 399 8399.01.64.8150	4003474351506	Nickel-matt / Nickel matt finished	1 x G9 / max. 28 W			3138	A++ E
4 Verre 399 8399.01.15.8150	4003474349190	Goldfarbig / Gold coloured	1 x G9 / max. 28 W			3138	A++ E

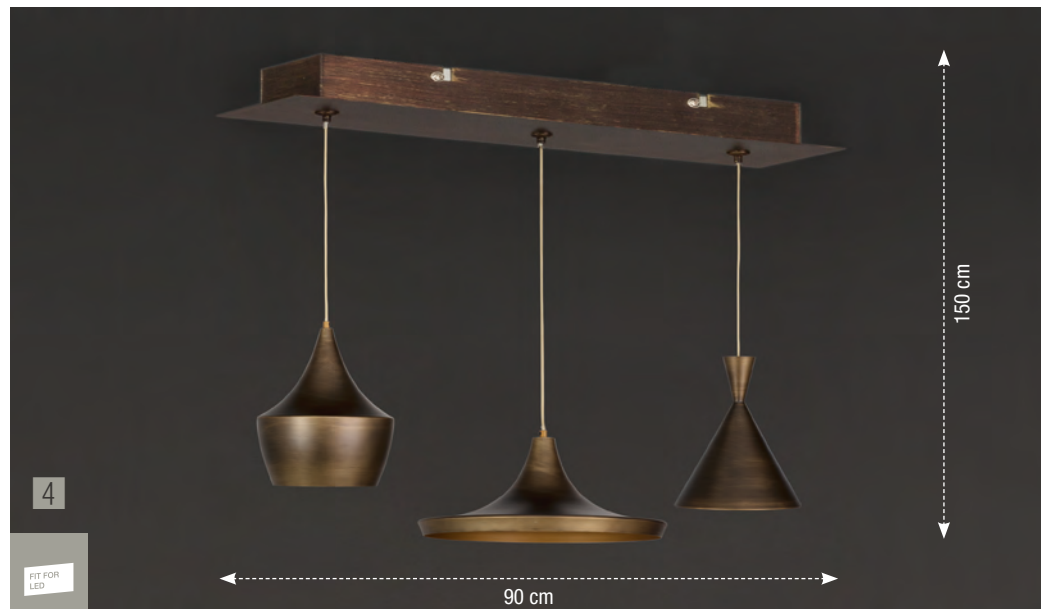

Serie / Series	EAN-Nr. / EAN-No.	Material / Material	Leuchtmittel / Lamp	Kelvin / Kelvin	Lumen / Lumen	Glas / Glass	EEK / EEC
1 Erin 232 6232.01.23.8380	4003474347349	Braun / Brown	1 x E27 / max. 60 W				A++ E
2 Vann 231 6231.01.23.8240	4003474347332	Braun / Brown	1 x E27 / max. 60 W				A++ E
3 Anur 233 6233.01.23.8250	4003474347356	Braun / Brown	1 x E27 / max. 60 W				A++ E
4 Vann 231 6231.03.23.8123	4003474352251	Braun / Brown	3 x E27 / max. 60 W				A++ E

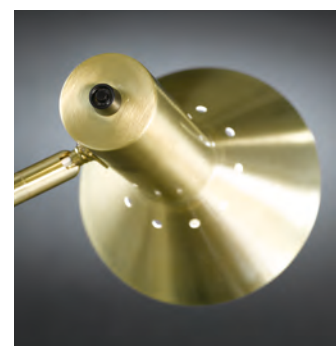
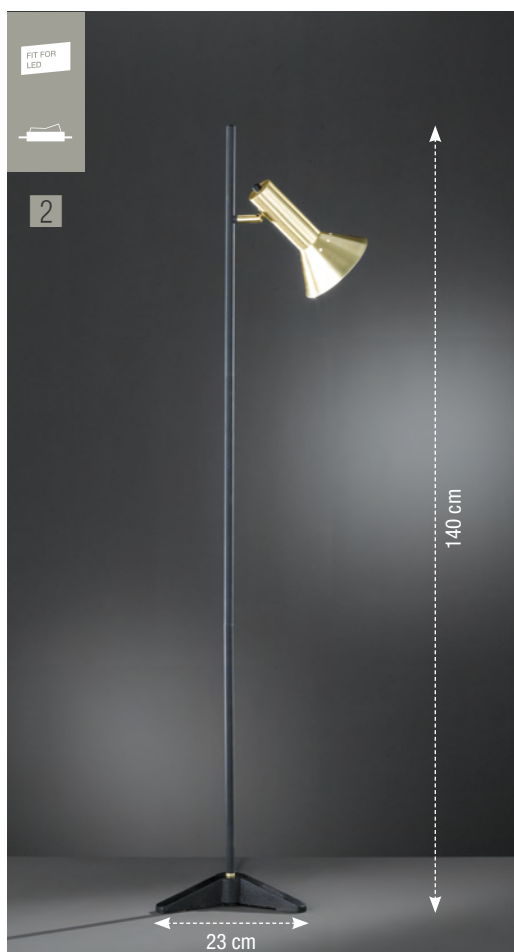

	Serie / Series	EAN-Nr. / EAN-No.	Material / Material	Leuchtmittel / Lamp	Kelvin / Kelvin	Lumen / Lumen	Glas / Glass	EEK / EEC
1	Mayra 316 3316.02.10.8000	4003474348490	Schwarz / Black	2 x E27 / max. 25 W				
2	Mayra 316 3316.01.10.8000	4003474348483	Schwarz / Black	1 x E27 / max. 25 W				
3	Valencia 612 7612.06.46.8000	4003474345352	Schwarz gold / Black gold	LED / 26 W (incl.)	3000 K	1800 lm		

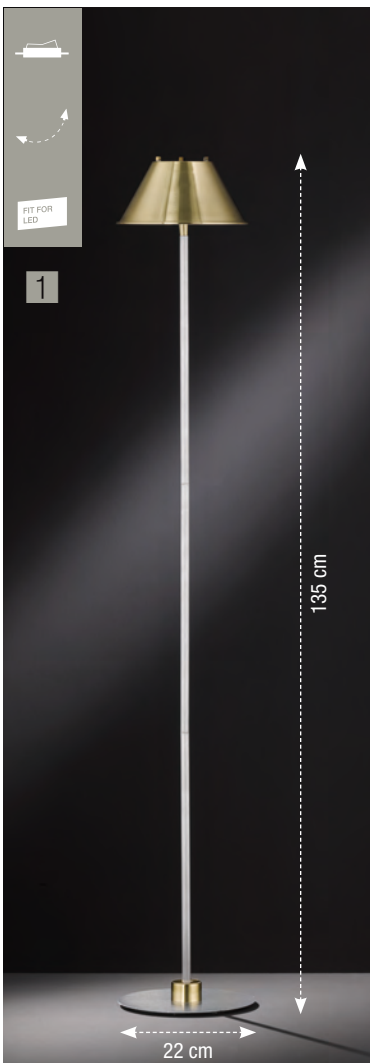
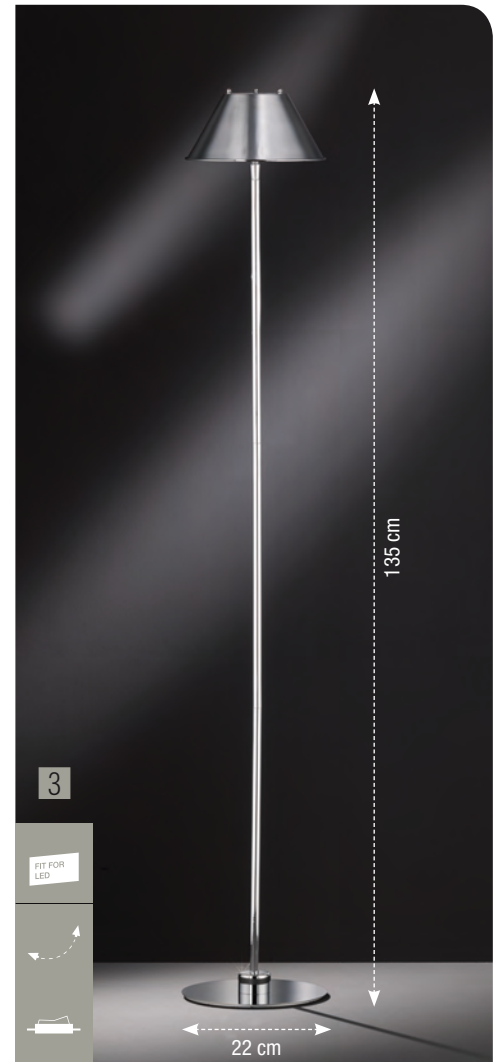

Serie / Series	EAN-Nr. / EAN-No.	Material / Material	Leuchtmittel / Lamp	Kelvin / Kelvin	Lumen / Lumen	Glas / Glass	EEK / EEC
1 Dylan 351 3351.01.15.8000	4003474343952	Goldfarbig / Gold coloured	1 x G9 / max. 10 W				
2 Dylan 351 8351.01.01.8000	4003474343914	Chrom / Chrome	1 x G9 / max. 10 W				
3 Dylan 351 3351.01.01.8000	4003474343945	Chrom / Chrome	1 x G9 / max. 10 W				
4 Dylan 351 8351.01.15.8000	4003474343921	Goldfarbig / Gold coloured	1 x G9 / max. 10 W				

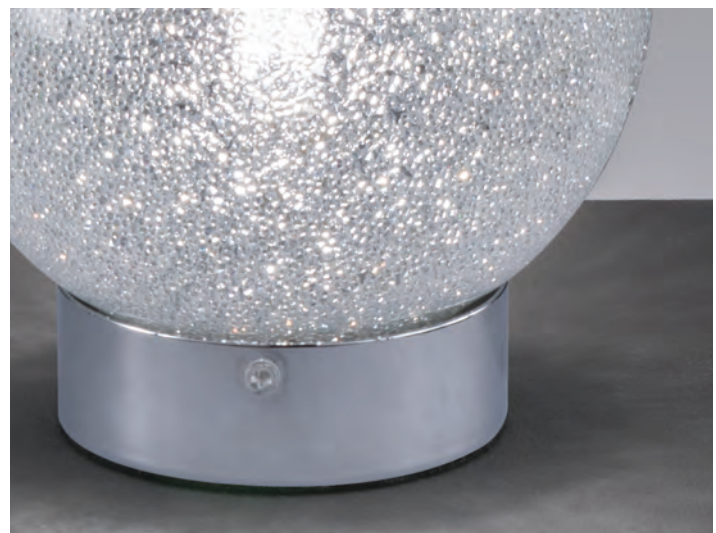

Serie / Series	EAN-Nr. / EAN-No.	Material / Material	Leuchtmittel / Lamp	Kelvin / Kelvin	Lumen / Lumen	Glas / Glass	EEK / EEC
1 Lenox 378 6378.01.01.8300	4003474349008	Chrom / Chrome	1 x E27 / max. 40 W				
2 Carat 375 8375.01.01.8150	4003474348995	Chrom / Chrome	1 x G9 / max. 33 W				



Serie / Series	EAN-Nr. / EAN-No.	Material / Material	Leuchtmittel / Lamp	Kelvin / Kelvin	Lumen / Lumen	Schirm / Shade	EEK / EEC
1 Cesena 324 8324.01.29.8000	4003474353708	Marineblau / Navy	1 x E14 / max. 42 W			5159	
2 Cesena 324 8324.01.94.8000	4003474353685	Rosa / Pink	1 x E14 / max. 42 W			5162	
3 Cesena 324 8324.01.70.8000	4003474353692	Silber / Silver	1 x E14 / max. 42 W			5161	
4 Cesena 324 8324.01.29.8001	4003474353715	Blau / Blue	1 x E14 / max. 42 W			5160	



Cosy Living

Cosy Living

Vintage Leuchten: beliebt, begehrt, behaglich

Sie lassen Räume gemütlicher wirken. Egal, ob in der Küche, im Wohn- oder Schlafzimmer... ein Blickfang mit hohem Wohlfühleffekt.

Vintage lamps: liked, popular, cosy

They let rooms be more cosy. No matter if it's in the kitchen, living or sleeping room... they are an eye-catcher to feel good.

LEIF | Seite 64 - 67

LEIF II | Seite 66

BELLE | Seite 68

CORDOBA | Seite 69

RODEZ | Seite 70

LYON | Seite 71

RACHEL | Seite 72

GIRONA | Seite 73

MONA | Seite 74 - 75





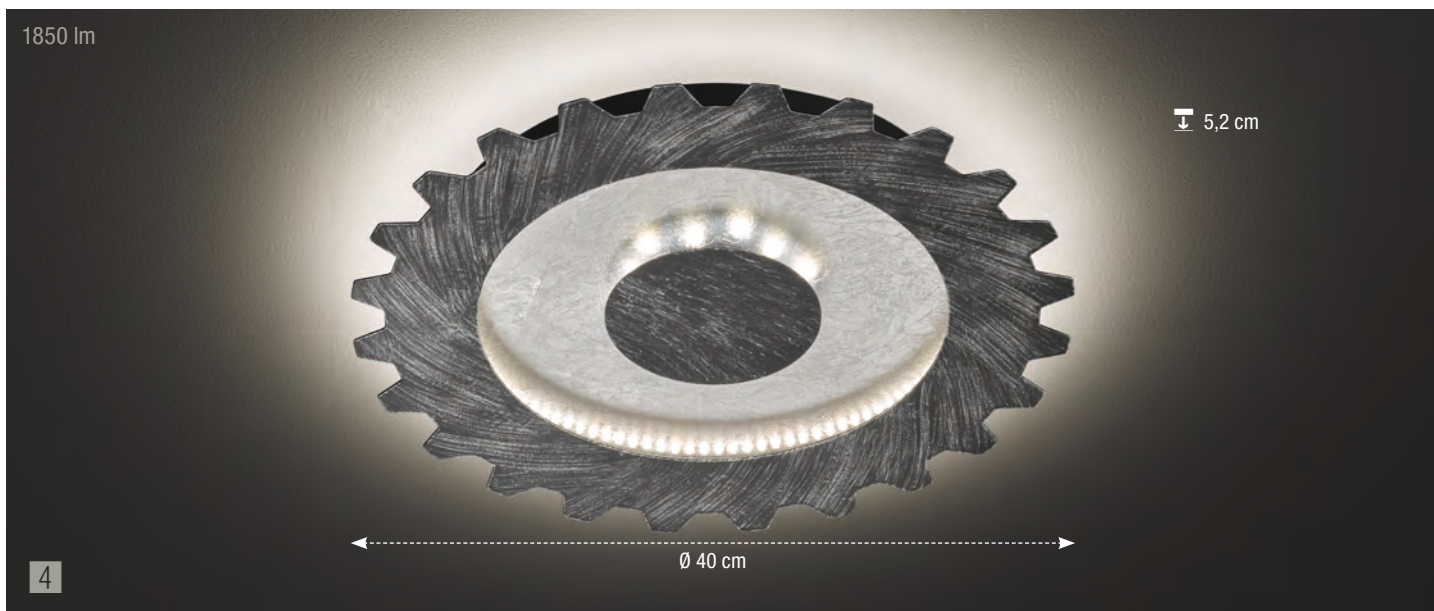
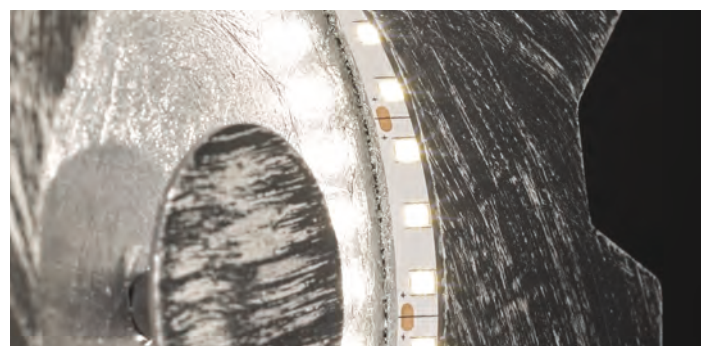
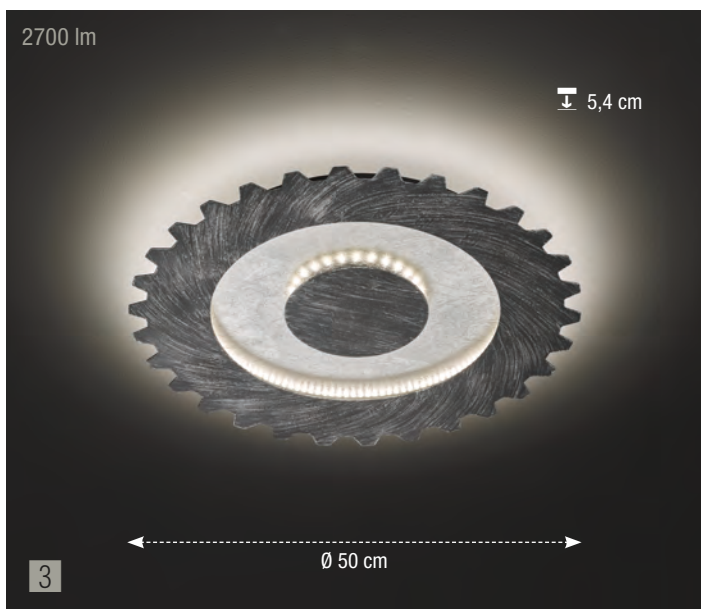
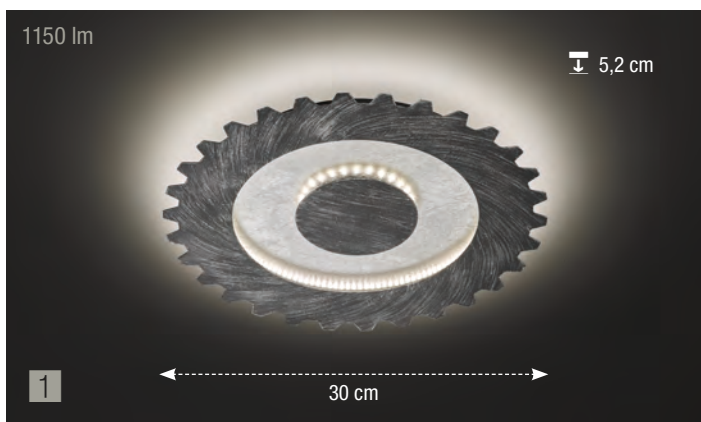

LED LIGHT by
WOFI

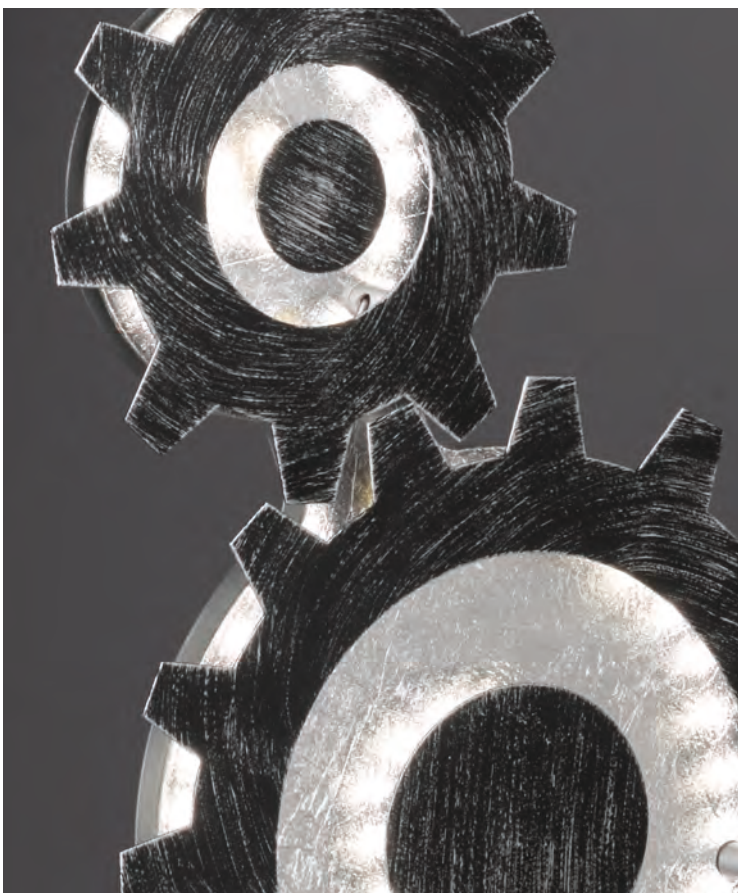

	Serie / Series	EAN-Nr. / EAN-No.	Material / Material	Leuchtmittel / Lamp	Kelvin / Kelvin	Lumen / Lumen	Glas / Glass	EEK / EEC
1	Leif 301 9301.02.70.8300	4003474352305	Silber / Silver	LED / 18 W (incl.)	3000 K	1150 lm		A
2	Leif 301 4301.02.70.8200	4003474351308	Silber / Silver	LED / 5 W (incl.)	3000 K	430 lm		A+
3	Leif 301 9301.02.70.8500	4003474351346	Silber / Silver	LED / 37 W (incl.)	3000 K	2700 lm		A
4	Leif 301 9301.02.70.8400	4003474351339	Silber / Silver	LED / 27 W (incl.)	3000 K	1850 lm		A



	Serie / Series	EAN-Nr. / EAN-No.	Material / Material	Leuchtmittel / Lamp	Kelvin / Kelvin	Lumen / Lumen	Glas / Glass	EEK / EEC
1	Leif II 215 8215.03.70.8301	4003474352176	Silber / Silver	 LED / 11 W (incl.)	3000 K	1430 lm		A ⁺
2	Leif II 215 3215.06.15.8301	4003474352190	Goldfarbig / Gold coloured	 LED / 22 W (incl.)	3000 K	2860 lm		A ⁺
3	Leif II 215 3215.06.70.8301	4003474352183	Silber *(ohne Abbildung) / Silver *(without illustration)	 LED / 22 W (incl.)	3000 K	2860 lm		A ⁺
4	Leif II 215 8215.03.15.8301	4003474352169	Goldfarbig *(ohne Abbildung) / Gold coloured *(without illustration)	 LED / 11 W (incl.)	3000 K	1430 lm		A ⁺

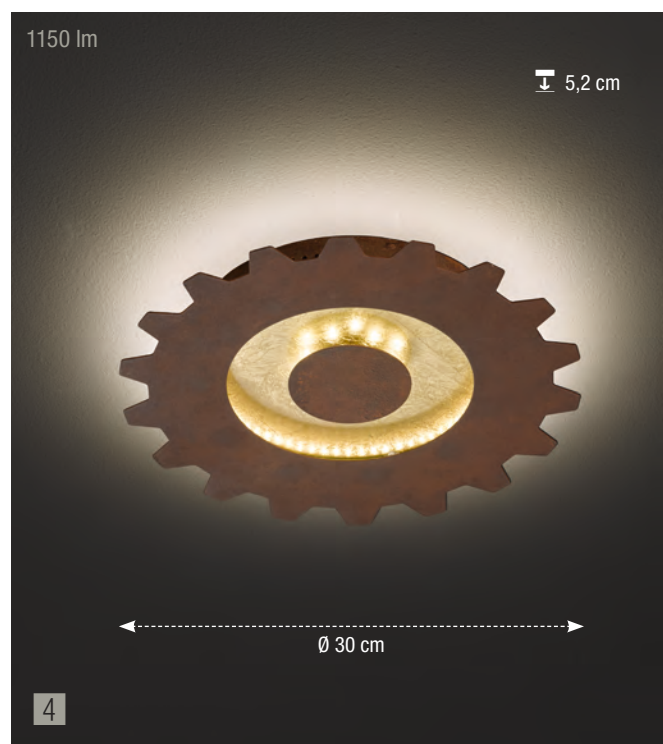

	Serie / Series	EAN-Nr. / EAN-No.	Material / Material	Leuchtmittel / Lamp	Kelvin / Kelvin	Lumen / Lumen	Glas / Glass	EEK / EEC
1	Leif 301 4301.02.15.8200	4003474351292	Goldfarbig / Gold coloured	LED / 5 W (incl.)	3000 K	430 lm		A+ →
2	Leif 301 9301.02.15.8500	4003474352220	Goldfarbig / Gold coloured	LED / 37 W (incl.)	3000 K	2700 lm		A →
3	Leif 301 9301.02.15.8400	4003474351322	Goldfarbig / Gold coloured	LED / 27 W (incl.)	3000 K	1850 lm		A →
4	Leif 301 9301.02.15.8300	4003474351315	Goldfarbig / Gold coloured	LED / 18 W (incl.)	3000 K	1150 lm		A →

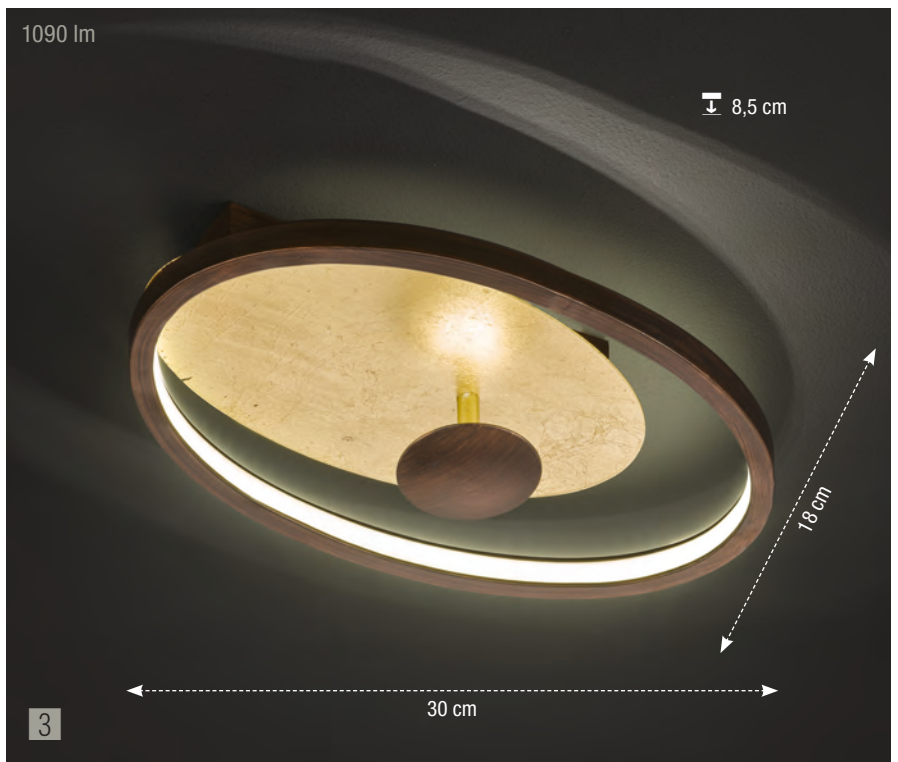
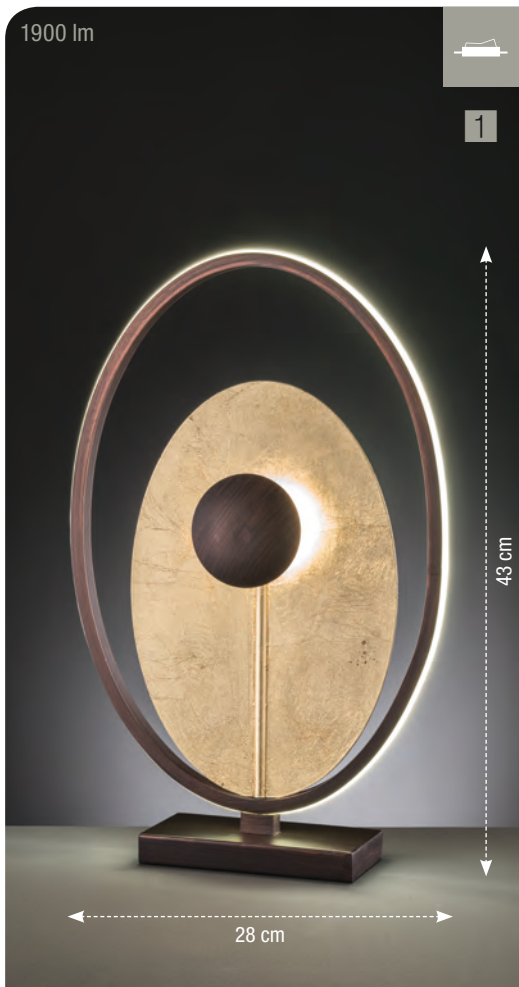



Serie / Series	EAN-Nr. / EAN-No.	Material / Material	Leuchtmittel / Lamp	Kelvin / Kelvin	Lumen / Lumen	Glas / Glass	EEK / EEC
1 Belle 268 8268.03.15.8000	4003474351223	Goldfarbig / Gold coloured	LED / 22 W (incl.)	3000 K	1900 lm		
2 Belle 268 9268.02.15.8400	4003474351247	Goldfarbig / Gold coloured	LED / 17 W (incl.)	3000 K	1450 lm		
3 Belle 268 9268.02.15.8300	4003474351230	Goldfarbig / Gold coloured	1ED / 15 W (incl.)	3000 K	1090 lm		



Serie / Series	EAN-Nr. / EAN-No.	Material / Material	Leuchtmittel / Lamp	Kelvin / Kelvin	Lumen / Lumen	Glas / Glass	EEK / EEC
1 Cordoba 874 8874.01.23.8000	4003474344652	Braun / Brown	1 x E27 / max. 60 W				A++ E
2 Cordoba 874 3874.01.23.8000	4003474344638	Braun / Brown	1 x E27 / max. 20 W				A++ E
3 Cordoba 874 9874.01.23.8000	4003474344669	Braun / Brown	1 x E27 / max. 60 W				A++ E
4 Cordoba 874 6874.01.23.8000	4003474344645	Braun / Brown	1 x E27 / max. 60 W				A++ E



Serie / Series	EAN-Nr. / EAN-No.	Material / Material	Leuchtmittel / Lamp	Kelvin / Kelvin	Lumen / Lumen	Glas / Glass	EEK / EEC
1 Rodez 884 7884.01.57.8000	4003474344997	Antik braun / Messing gefärbt Antique brown / Coloured brass	 1 x LED / 22 W (incl.)	3000 K	1 x 1380 lm		

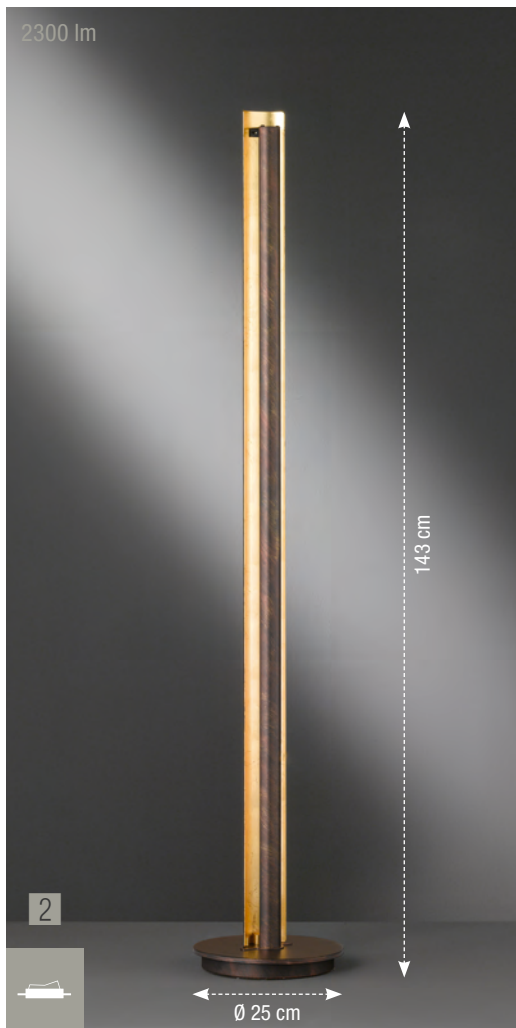

Serie / Series	EAN-Nr. / EAN-No.	Material / Material	Leuchtmittel / Lamp	Kelvin / Kelvin	Lumen / Lumen	Glas / Glass	EEK / EEC
1 Lyon 584 8584.01.57.8000	4003474344935	Antik braun / Messing gefärbt Antique brown / Coloured brass	1 x LED / 13 W (incl.) LED Board	3000 K	1 x 800 lm		
2 Lyon 584 3584.01.57.8000	4003474344942	Antik braun / Messing gefärbt Antique brown / Coloured brass	1 x LED / 36 W (incl.) LED Board	3000 K	1 x 2300 lm		
3 Lyon 584 4584.01.57.8000	4003474344959	Antik braun / Messing gefärbt Antique brown / Coloured brass	1 x LED / 12 W (incl.) LED Board	3000 K	1 x 750 lm		

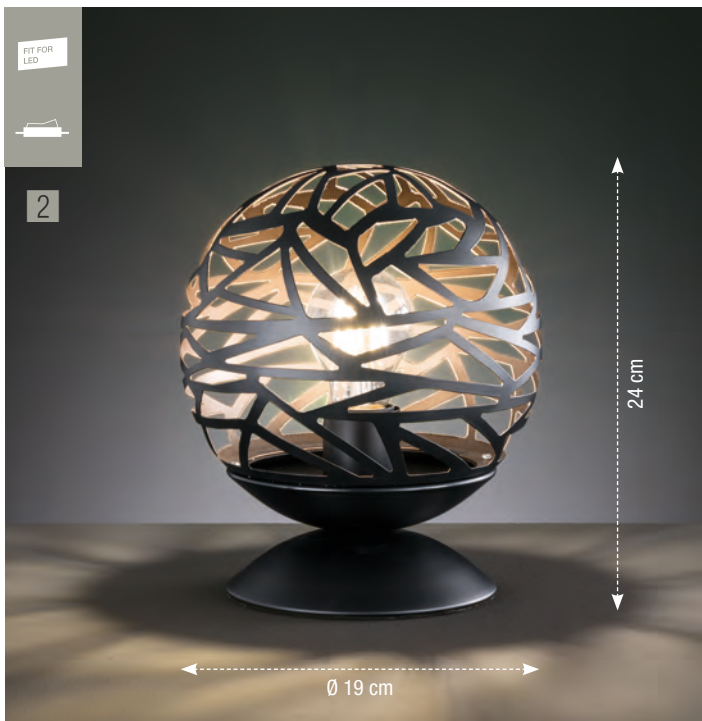

	Serie / Series	EAN-Nr. / EAN-No.	Material / Material	Leuchtmittel / Lamp	Kelvin / Kelvin	Lumen / Lumen	Glas / Glass	EEK / EEC
1	Rachel 363 6363.01.46.8300	4003474348841	Schwarz Gold / Black Gold	1 x E27 / max. 60 W				
2	Rachel 363 8363.01.46.8250	4003474348902	Schwarz Gold / Black Gold	1 x E27 / max. 60 W				



Serie / Series	EAN-Nr. / EAN-No.	Material / Material	Leuchtmittel / Lamp	Kelvin / Kelvin	Lumen / Lumen	Glas / Glass	EEK / EEC
1 Girona 497 6497.01.15.8000	4003474344195	Goldfarbig / Gold coloured	1 x E27 / max. 60 W				
2 Girona 497 6497.03.15.8000	4003474344218	Goldfarbig / Gold coloured	3 x E27 / max. 60 W				

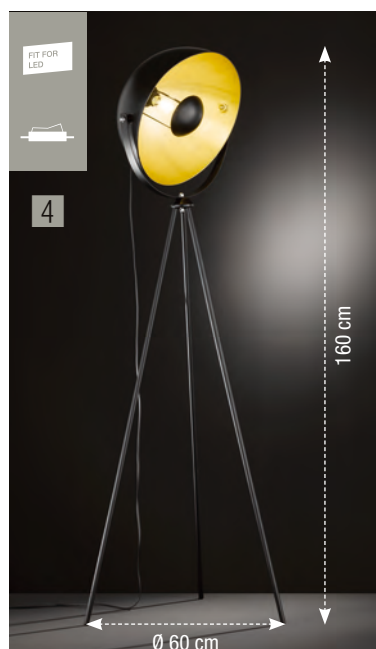

	Serie / Series	EAN-Nr. / EAN-No.	Material / Material	Leuchtmittel / Lamp	Kelvin / Kelvin	Lumen / Lumen	Glas / Glass	EEK / EEC
1	Mona 019 3019.01.50.8000	4003474348285	Grau / Grey	1 x E27 / max. 60 W				
2	Mona 019 9019.01.50.8000	4003474348261	Grau / Grey	1 x E27 / max. 60 W				
3	Mona 019 8019.01.50.8000	4003474348278	Grau / Grey	1 x E14 / max. 25 W				
4	Mona 019 3019.01.10.7000	4003474342450	Schwarz / Black	1 x E27 / max. 60 W				

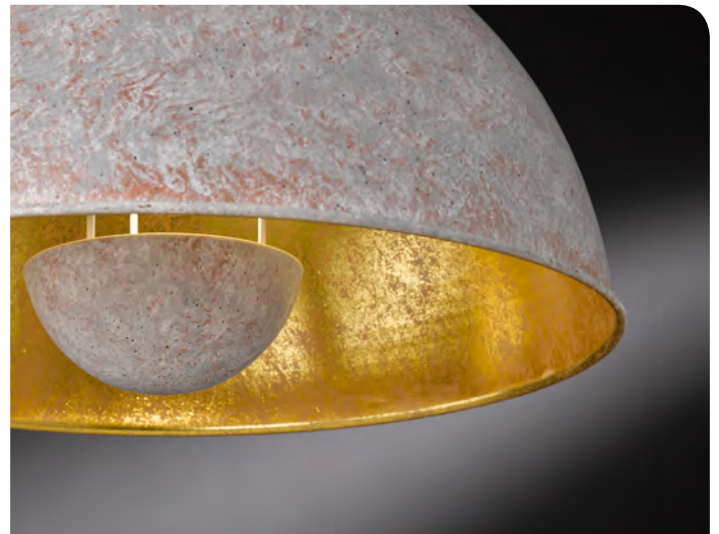

Serie / Series	EAN-Nr. / EAN-No.	Material / Material	Leuchtmittel / Lamp	Kelvin / Kelvin	Lumen / Lumen	Glas / Glass	EEK / EEC
1 Mona 019 6019.01.50.8000	4003474348254	Grau / Grey	1 x E27 / max. 60 W				
2 Mona 019 7019.03.50.8000	4003474348247	Grau / Grey	3 x E14 / max. 40 W				



Wand- & Deckenleuchten

Wall & ceiling lights

Leuchten mit Vision

Sie lassen Räume größer wirken oder Flure breiter: Das Licht unserer Wand- und Deckenleuchten beeinflusst die räumliche Wahrnehmung. In moderner, klassischer oder avantgardistischer Ausführung.

Lamps with a vision

They make rooms seem bigger and hallways seem wider: the light from our wall and ceiling lights influences depth perception. Available in modern, classic and avant-garde styles.

COUNTY | Seite 78 - 79

LORD | Seite 80

CAMERON | Seite 81

VALLEY | Seite 82 - 83

CAYENNE | Seite 84

HUDSON | Seite 84

QUEBEC | Seite 85

GALWAY | Seite 85



LED LIGHT by
WOFI®



Serie / Series	EAN-Nr. / EAN-No.	Material / Material	Leuchtmittel / Lamp	Kelvin / Kelvin	Lumen / Lumen	Glas / Glass	EEK / EEC
1 County 935 9935.01.06.8910	4003474349992	Weiß / White	1 x LED / 81 W (incl.)	3000-6000 K	1 x 8800 lm		A+ →
2 County 935 9935.01.06.8750	4003474349985	Weiß / White	1 x LED / 63 W (incl.)	3000-6000 K	1 x 7100 lm		A+ →

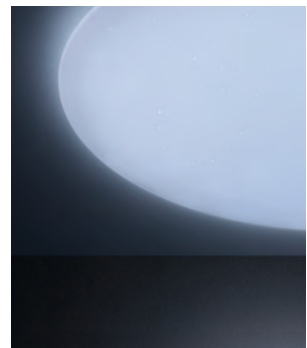

Serie / Series	EAN-Nr. / EAN-No.	Material / Material	Leuchtmittel / Lamp	Kelvin / Kelvin	Lumen / Lumen	Glas / Glass	EEK / EEC
1 Lord 198 9198.01.06.7000	4003474340814	Weiß / White	1 x LED / 88 W (incl.) LED Board	3000-6800 K	1 x 9300 lm		

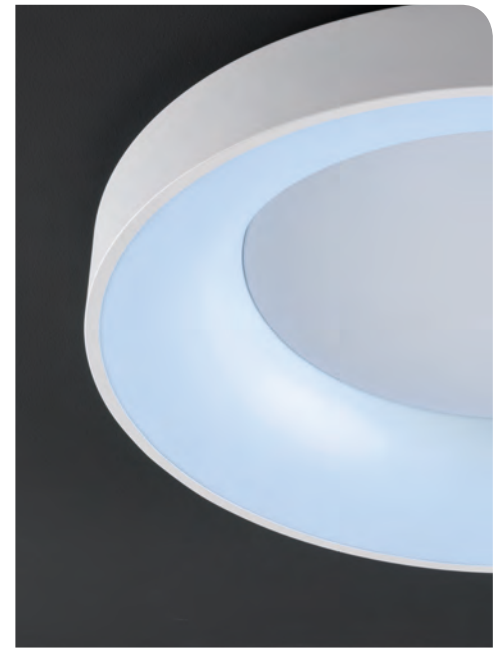

Serie / Series	EAN-Nr. / EAN-No.	Material / Material	Leuchtmittel / Lamp	Kelvin / Kelvin	Lumen / Lumen	Glas / Glass	EEK / EEC
1 Cameron 417 9417.01.06.8780	4003474349435	Weiß / White	1 x LED / 62 W (incl.) LED Board	3000-6500 K	1 x 7200 lm		A



LED LIGHT by
WOFi®

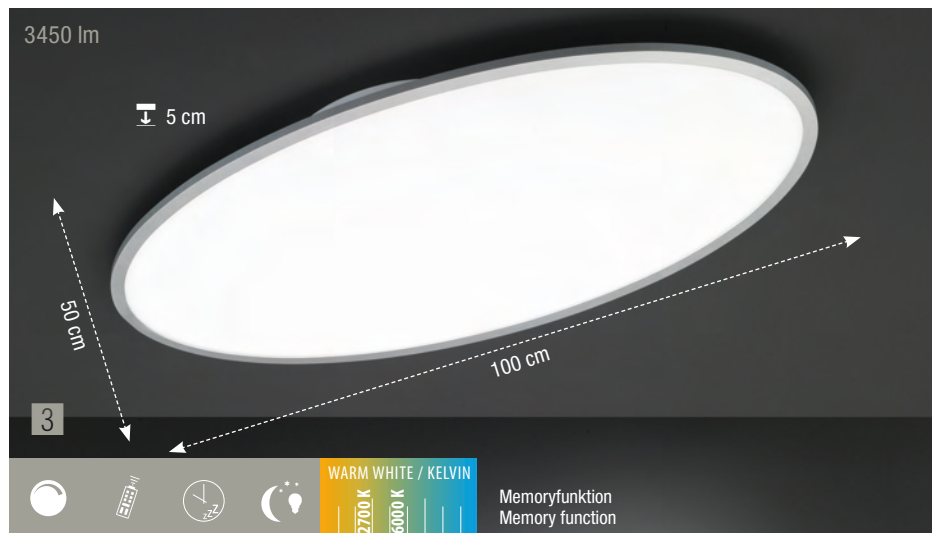
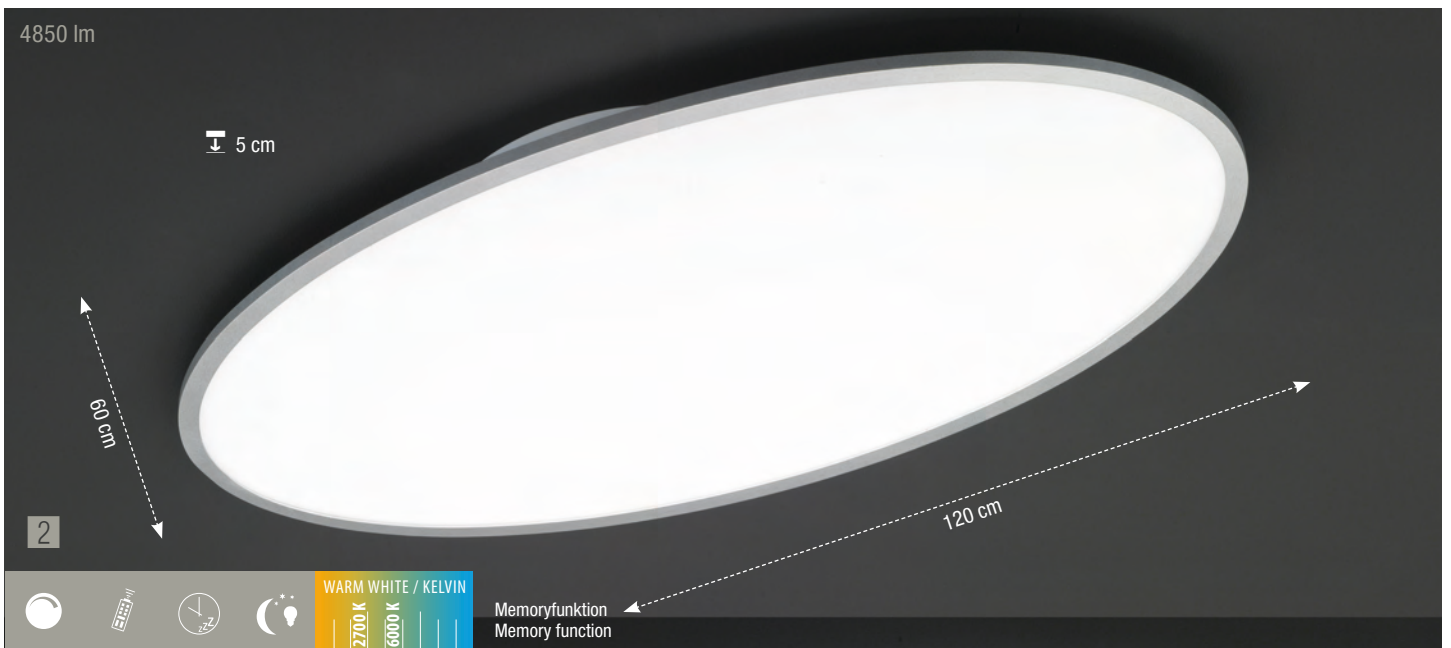
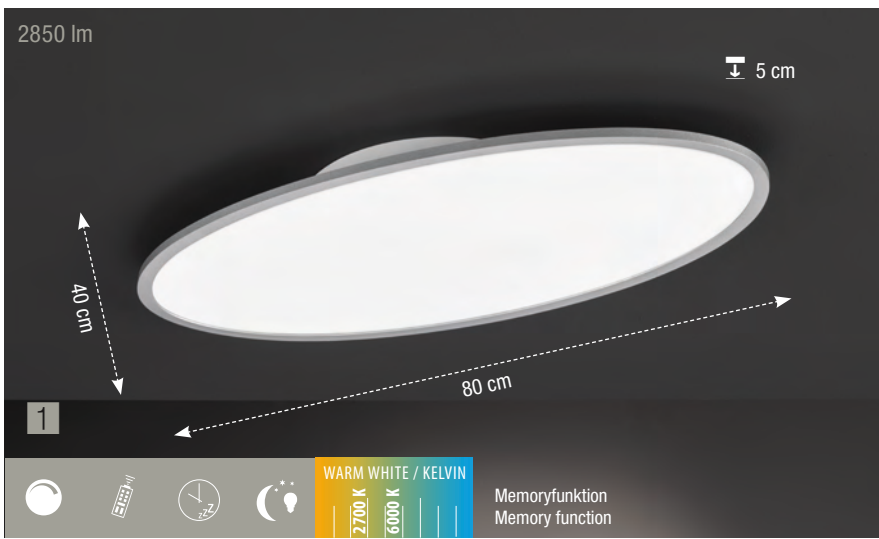

Serie / Series	EAN-Nr. / EAN-No.	Material / Material	Leuchtmittel / Lamp	Kelvin / Kelvin	Lumen / Lumen	Glas / Glass	EEK / EEC
1 Valley 970 9970.01.06.8000	4003474350752	Weiß / White	1 x LED / 36 W (incl.)	2700-6000 K	1 x 2850 lm		A
2 Valley 970 9970.01.06.8200	4003474350776	Weiß / White	1 x LED / 53 W (incl.)	2700-6000 K	1 x 4850 lm		A+
3 Valley 970 9970.01.06.8100	4003474350769	Weiß / White	1 x LED / 45 W (incl.)	2700-6000 K	1 x 3450 lm		A

2500 lm

11 cm



43 cm

1

2600 lm

13 cm



50 cm

2



1700 lm

13 cm



35 cm

3

	Serie / Series	EAN-Nr. / EAN-No.	Material / Material	Leuchtmittel / Lamp	Kelvin / Kelvin	Lumen / Lumen	Glas / Glass	EEK / EEC
1	Cayenne 065 9065.01.51.8100	4003474347370	Holz / Wood	 1 x LED / 34 W (incl.)	3000 K	1 x 2500 lm		A
2	Hudson 042 9042.01.51.8100	4003474346380	Holz / Wood	 1 x LED / 34 W (incl.)	3000 K	1 x 2600 lm		A
3	Hudson 042 9042.01.51.8000	4003474346373	Holz / Wood	 1 x LED / 24 W (incl.)	3000 K	1 x 1700 lm		A

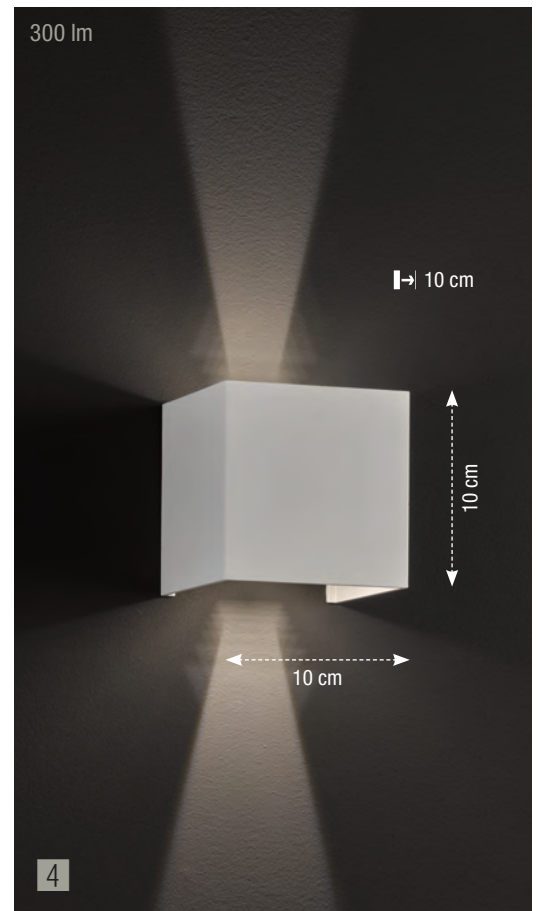
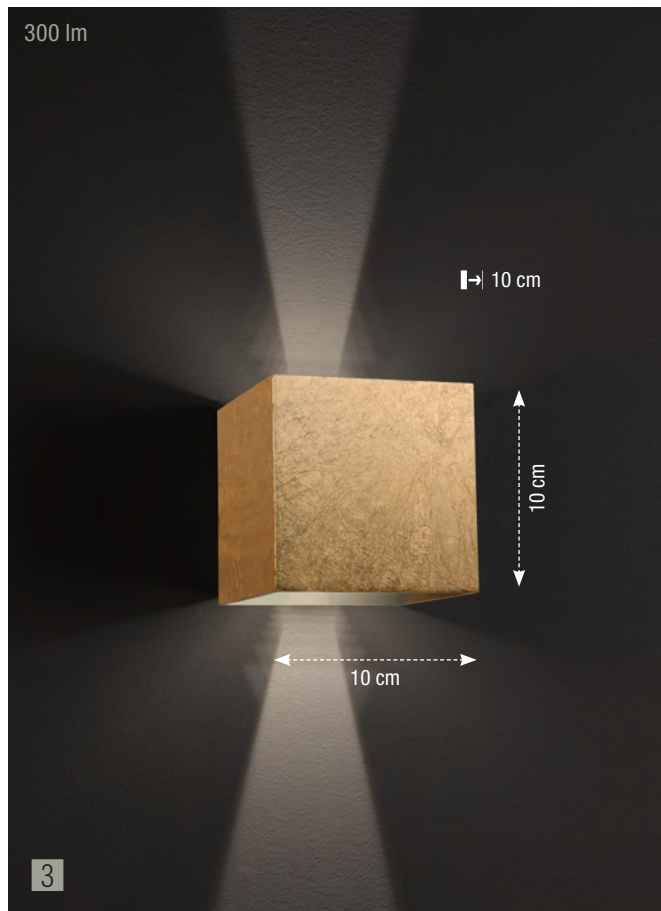
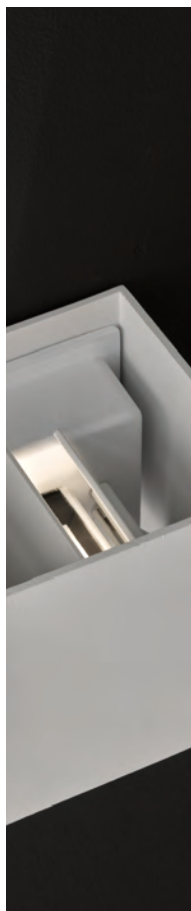
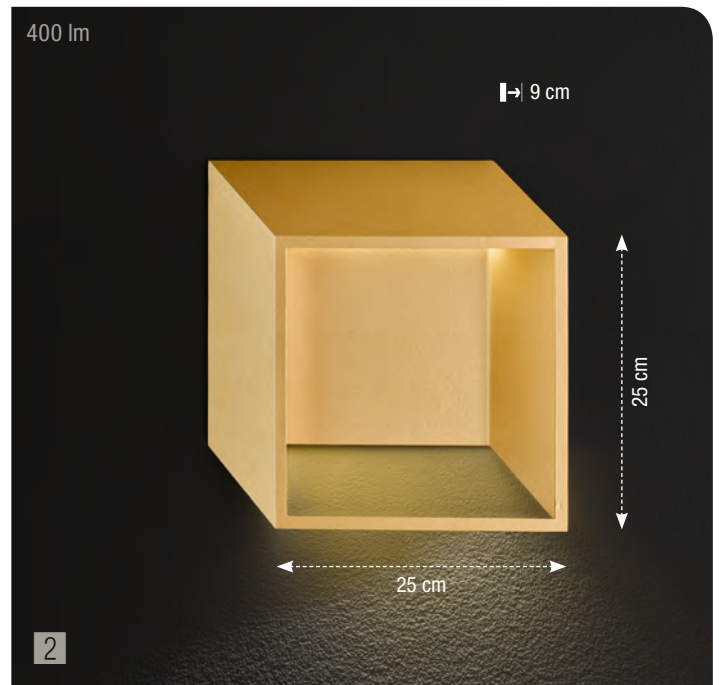
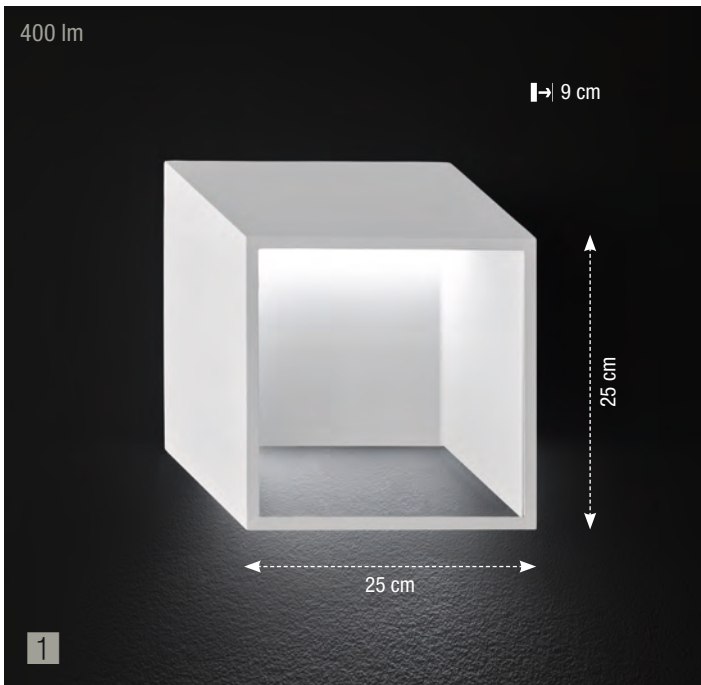

Serie / Series	EAN-Nr. / EAN-No.	Material / Material	Leuchtmittel / Lamp	Kelvin / Kelvin	Lumen / Lumen	Glas / Glass	EEK / EEC
1 Quebec 416 4416.01.06.8000	4003474349411	Weiß / White	1 x LED / 5.5 W (incl.)	3000 K	1 x 400 lm		A+ →
2 Quebec 416 4416.01.15.8000	4003474349428	Goldfarbig / Gold coloured	1 x LED / 5.5 W (incl.)	3000 K	1 x 400 lm		A+ →
3 Galway 567 4567.01.15.8000	4003474351964	Goldfarbig / Gold coloured	1 x LED / 5 W (incl.)	3000 K	1 x 300 lm		A →
4 Galway 567 4567.01.06.8000	4003474351568	Weiß / White	1 x LED / 5 W (incl.)	3000 K	1 x 300 lm		A →



Strahlerserien

Spotlight series

Bringen Licht auf den Punkt

Pures Design und eine effiziente Technologie lassen unsere Spots
– im wahrsten Sinne des Wortes – erstrahlen!
Optimal für punktuelle Lichtquellen im Wohnraum.

Focused lighting

*Pure designs and efficient technology quite literally make
our spotlights shine. Ideal if you need focused light sources
in your home.*

SCOPE | Seite 88 - 89

VERIA | Seite 90



Serie / Series	EAN-Nr. / EAN-No.	Material / Material	Leuchtmittel / Lamp	Kelvin / Kelvin	Lumen / Lumen	Glas / Glass	EEK / EEC
1 Scope I 314 4314.02.64.8000	4003474348421	Nickel-matt / Nickel matt finished	2 x E27 / max. 25 W				
2 Scope I 314 4314.01.64.8000	4003474349442	Nickel-matt / Nickel matt finished	1 x E27 / max. 25 W				
3 Scope I 314 3314.03.64.8000	4003474348452	Nickel-matt / Nickel matt finished	3 x E27 / max. 25 W				



	Serie / Series	EAN-Nr. / EAN-No.	Material / Material	Leuchtmittel / Lamp	Kelvin / Kelvin	Lumen / Lumen	Glas / Glass	EEK / EEC
1	Scope 314 4314.04.64.8000	4003474348438	Nickel-matt / Nickel matt finished	4 x E27 / max. 25 W				
2	Scope 314 8314.01.64.8000	4003474348445	Nickel-matt / Nickel matt finished	1 x E27 / max. 25 W				

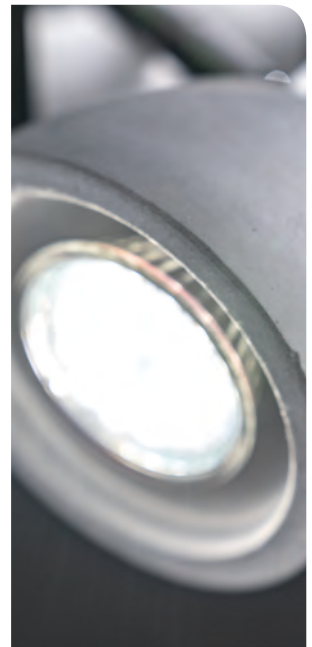
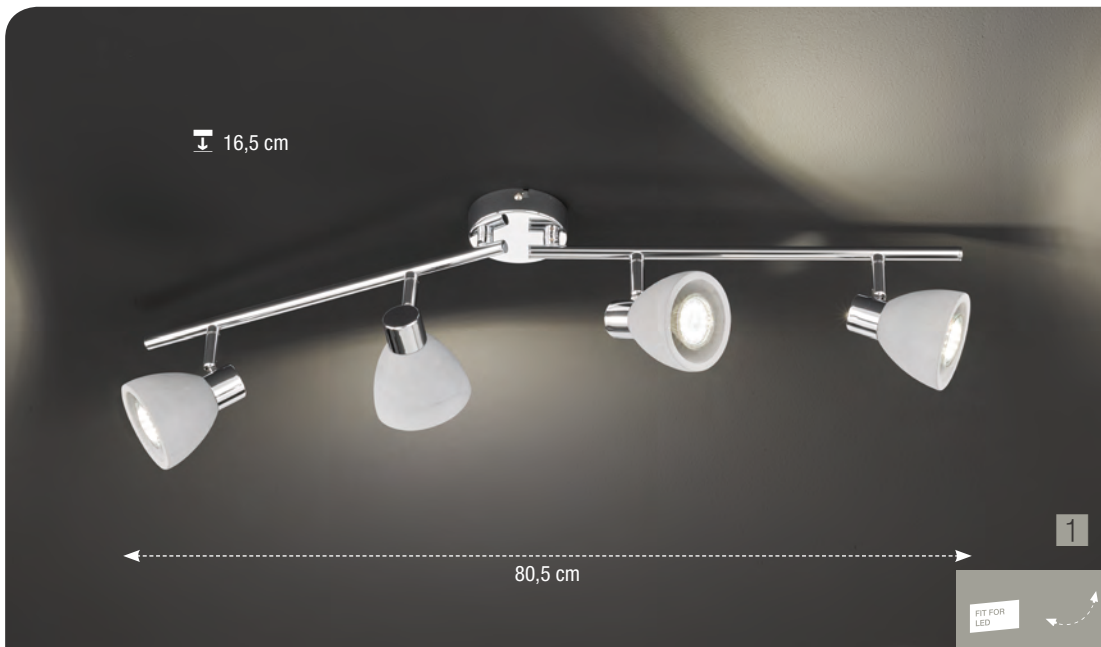

	Serie / Series	EAN-Nr. / EAN-No.	Material / Material	Leuchtmittel / Lamp	Kelvin / Kelvin	Lumen / Lumen	Glas / Glass	EEK / EEC
1	Veria 554 9554.04.50.8000	4003474344515	Grau / Grey	4 x GU10 / max. 35 W			5155	
2	Veria 554 4554.01.50.8000	4003474344492	Grau / Grey	1 x GU10 / max. 35 W			5155	
3	Veria 554 4554.02.50.8000	4003474344508	Grau / Grey	2 x GU10 / max. 35 W			5155	

SERIENVERZEICHNIS / SERIES INDEX

Serie	Name	Serie	Name
Series	Name	Series	Name
293	ANESA	170	RISA
330	ANGERS	884	RODEZ
233	ANUR	539	RONDA
341	AURELIA	325	SAFIRA
188	AVERY	365	SARA
268	BELLE	314	SCOPE
417	CAMERON	323	SIGNE
375	CARAT	159	SKIP
445	CARMONA	086	SPRING
065	CAYENNE	096	SYDNEY
324	CESENA	565	TANDIL
874	CORDOBA	612	VALENCIA
935	COUNTY	970	VALLEY
185	DINA	231	VANN
351	DYLAN	554	VERIA
410	ELIOT	399	VERRE
232	ERIN	531	VISO
567	GALWAY	255	YORK
359	GINO		
497	GIRONA		
164	GRACE		
042	HUDSON		
134	INDIGO		
344	JULS		
266	KIT		
301	LEIF		
215	LEIF II		
378	LENOX		
319	LIVIA		
198	LORD		
584	LYON		
316	MAYRA		
103	MEDLEY		
166	MIA		
243	MODESTO		
019	MONA		
414	MONTREAL		
422	OPUS		
416	QUEBEC		
363	RACHEL		

INDEX / INDEX

Der vorliegende Index ist nach WOFI-Serien-Nummern sortiert. Die drei Ziffern vor dem 1. Punkt geben die genaue Serie an.
The present index participates sorted after WOFI-series-numbers. The three digits before the point declare the exactly series-numbers.

Im Nachfolgenden handelt es sich um die Serie 019.
It is in the following about the series 019.

Serien-Nummer
Series-Number
3019.01.10.7000
 WOFI Artikel-Nummer
WOFI Item-Number

Serie	Artikel-Nr.	EAN-Nr.	Seite	Serie	Artikel-Nr.	EAN-Nr.	Seite	Serie	Artikel-Nr.	EAN-Nr.	Seite	
Series	Item-No.	EAN-No.	Page	Series	Item-No.	EAN-No.	Page	Series	Item-No.	EAN-No.	Page	
019	3019.01.10.7000	4003474342450	74	185	6185.06.15.8000	4003474343150	55	301	4301.02.15.8200	4003474351292	67	
	3019.01.50.8000	4003474348285	74		8185.03.15.8000	4003474343136	55		4301.02.70.8200	4003474351308	65	
	6019.01.50.8000	4003474348254	75		188	9188.05.01.8000	4003474347080		56	9301.02.15.8300	4003474351315	67
	7019.03.50.8000	4003474348247	75			9188.07.15.8000	4003474347110		56	9301.02.15.8400	4003474351322	67
	8019.01.50.8000	4003474348278	74		198	9198.01.06.7000	4003474340814		80	9301.02.15.8500	4003474352220	67
	9019.01.50.8000	4003474348261	74			215	3215.06.15.8301		4003474352190	66	9301.02.70.8300	4003474352305
042	9042.01.51.8000	4003474346373	84	3215.06.70.8301	4003474352183		66	9301.02.70.8400	4003474351339	65		
	9042.01.51.8100	4003474346380	84	8215.03.15.8301	4003474352169	66	9301.02.70.8500	4003474351346	65			
065	9065.01.51.8100	4003474347370	84	8215.03.70.8301	4003474352176	66	314	3314.03.64.8000	4003474348452	88		
086	6086.01.01.8100	4003474342733	30	231	6231.01.23.8240	4003474347332		57	4314.01.64.8000	4003474349442	88	
	096	3096.01.51.8000	4003474350714		33	6231.03.23.8123	4003474352251	57	4314.02.64.8000	4003474348421	88	
7096.01.51.8000		4003474350677	33	232	6232.01.23.8380	4003474347349	57	4314.04.64.8000	4003474348438	89		
8096.01.51.8000	4003474350707	33	233		6233.01.23.8250	4003474347356	57	8314.01.64.8000	4003474348445	89		
103	9103.01.01.8420	4003474350806		40	243	9243.03.44.8000	4003474351629	23	316	3316.01.10.8000	4003474348483	58
	9103.01.01.8460	4003474350790	40	9243.03.70.8300		4003474350899	23	3316.02.10.8000		4003474348490	58	
134	6134.01.70.8000	4003474346878	29	9243.03.70.8400	4003474350905	23	319	6319.01.64.8000	4003474351926	28		
	9134.01.70.8000	4003474349657	29	255	3255.04.10.8000	4003474347462		51	7319.03.64.8000	4003474351933	28	
159	3159.01.63.8000	4003474352947	24		8255.02.10.8000	4003474347455	51	9319.01.64.8000	4003474351940	28		
	7159.01.63.8000	4003474352954	24	9255.05.10.8000	4003474347479	51	323	6323.01.64.8000	4003474343532	27		
7159.01.63.8100	4003474352961	25	266	6266.01.63.8000	4003474347561	31		8323.01.64.8000	4003474343549	27		
8159.01.63.8000	4003474352978	24		268	8268.03.15.8000	4003474351223	68	9323.01.64.8000	4003474343518	27		
9159.01.63.8000	4003474352985	25	9268.02.15.8300		4003474351230	68	324	8324.01.29.8000	4003474353708	61		
9159.01.63.8100	4003474353005	25	9268.02.15.8400	4003474351247	68	8324.01.29.8001		4003474353715	61			
164	6164.01.01.8300	4003474346847	46	293	4293.01.01.8000	4003474347783	38	8324.01.70.8000	4003474353692	61		
	6164.01.01.8400	4003474346830	46		4293.02.01.8000	4003474347790	39	8324.01.94.8000	4003474353685	61		
166	6166.04.01.8000	4003474346885	45	4293.03.01.8000	4003474347806	39	325	3325.03.15.8000	4003474348575	6		
	8166.01.01.8150	4003474346861	45	6293.03.01.8000	4003474347813	38		3325.03.70.8000	4003474348582	5		
	8166.01.01.8250	4003474346854	45	9293.04.01.8000	4003474351421	39		4325.02.15.8000	4003474348599	6		
170	9170.01.70.8000	4003474346915	30	9293.04.01.8100	4003474351438	38	4325.02.70.8000	4003474348605	5			
185	3185.05.15.8000	4003474343167	55	301	4301.02.15.8200	4003474351292	67	8325.01.15.8000	4003474348551	6		

Serie	Artikel-Nr.	EAN-Nr.	Seite	Serie	Artikel-Nr.	EAN-Nr.	Seite	Serie	Artikel-Nr.	EAN-Nr.	Seite
Series	Item-No.	EAN-No.	Page	Series	Item-No.	EAN-No.	Page	Series	Item-No.	EAN-No.	Page
325	8325.01.70.8000	4003474348568	5	410	9410.02.15.8100	4003474349268	10		9565.06.46.8100	4003474344560	49
	9325.01.15.8000	4003474348612	6		9410.02.70.8000	4003474349305	8		9565.06.46.8200	4003474344577	49
	9325.01.70.8000	4003474348629	5		9410.02.70.8100	4003474349336	10		567	4567.01.06.8000	4003474351568
330	4330.01.15.8120	4003474348636	7		9410.03.15.8000	4003474349244	9		4567.01.15.8000	4003474351964	85
	4330.01.15.8170	4003474348643	7		9410.03.15.8100	4003474349275	10	584	3584.01.57.8000	4003474344942	71
	4330.01.15.8300	4003474348650	7		9410.03.70.8000	4003474349312	8		4584.01.57.8000	4003474344959	71
	4330.01.15.8400	4003474348667	7		9410.03.70.8100	4003474349343	10		8584.01.57.8000	4003474344935	71
341	3341.05.64.8000	4003474346175	35	414	6414.05.64.8000	4003474351957	26	612	7612.06.46.8000	4003474345352	58
	7341.06.64.8000	4003474343884	35	416	4416.01.06.8000	4003474349411	85	874	3874.01.23.8000	4003474344638	69
	8341.01.64.8000	4003474343853	35		4416.01.15.8000	4003474349428	85		6874.01.23.8000	4003474344645	69
	8341.02.64.8000	4003474343860	35	417	9417.01.06.8780	4003474349435	81		8874.01.23.8000	4003474344652	69
	9341.05.64.8000	4003474346182	35	422	9422.01.15.8450	4003474346939	13		9874.01.23.8000	4003474344669	69
344	9344.03.15.8000	4003474346991	14		9422.01.15.8700	4003474346946	13	884	7884.01.57.8000	4003474344997	70
	9344.03.63.8000	4003474347004	14		9422.01.15.8900	4003474346977	13	935	9935.01.06.8750	4003474349985	79
351	3351.01.01.8000	4003474343945	59		9422.01.63.8450	4003474346953	12		9935.01.06.8910	4003474349992	79
	3351.01.15.8000	4003474343952	59		9422.01.63.8700	4003474346960	12	970	9970.01.06.8000	4003474350752	83
	8351.01.01.8000	4003474343914	59		9422.01.63.8900	4003474346984	12		9970.01.06.8100	4003474350769	83
	8351.01.15.8000	4003474343921	59	445	6445.06.09.8000	4003474344102	48		9970.01.06.8200	4003474350776	83
359	6359.01.01.8300	4003474348797	41		6445.12.09.8000	4003474345420	48				
	6359.01.01.8400	4003474348803	41	497	6497.01.15.8000	4003474344195	73				
	8359.01.01.8250	4003474348810	41		6497.03.15.8000	4003474344218	73				
363	6363.01.46.8300	4003474348841	72	531	3531.02.64.8000	4003474347974	20				
	8363.01.46.8250	4003474348902	72		6531.03.64.8000	4003474349718	21				
365	6365.03.46.8000	4003474348971	53		6531.04.64.8000	4003474347998	22				
	6365.03.54.8000	4003474348988	52		6531.09.64.8000	4003474348070	22				
	6365.04.46.8000	4003474349817	53		7531.03.64.8000	4003474347981	21				
	6365.04.54.8000	4003474349824	52		7531.04.64.8000	4003474348001	22				
	9365.08.46.8000	4003474348933	53		7531.04.64.8100	4003474348063	19				
	9365.08.54.8000	4003474348940	52		8531.02.64.8000	4003474348056	20				
		8375.01.01.8150	4003474348995	60		9531.03.64.8000	4003474347943	19			
378	6378.01.01.8300	4003474349008	60		9531.03.64.8400	4003474347967	21				
399	8399.01.15.8150	4003474349190	56		9531.05.64.8000	4003474350370	20				
	8399.01.64.8150	4003474351506	56	539	3539.01.01.8000	4003474344317	47				
410	3410.03.15.8000	4003474349299	9		3539.01.09.8000	4003474344300	47				
	3410.03.70.8000	4003474349367	8		8539.01.01.8000	4003474344331	47				
	6410.03.15.8000	4003474349251	11		8539.01.09.8000	4003474344324	47				
	6410.03.70.8000	4003474349329	11	554	4554.01.50.8000	4003474344492	90				
	8410.01.15.8000	4003474349282	9		4554.02.50.8000	4003474344508	90				
	8410.01.70.8000	4003474349350	8		9554.04.50.8000	4003474344515	90				
	9410.02.15.8000	4003474349237	9	565	9565.04.46.8000	4003474344584	49				

ALLGEMEINE VERKAUFSBEDINGUNGEN

- 1.** Allen unseren Lieferverträgen – auch zukünftigen – liegen unsere allgemeinen Verkaufsbedingungen zugrunde. Spätestens mit der Entgegennahme der Lieferung gelten unsere Bedingungen als angenommen. Einkaufs-, Lieferungs- und Zahlungsbedingungen des Bestellers haben keine Gültigkeit, soweit sie unseren Allgemeinen Verkaufsbedingungen entgegenstehen. Alle bisherigen Bedingungen und Vereinbarungen verlieren mit Erscheinen des Kataloges WOFI LEUCHTEN 2018 ihre Gültigkeit.
- 2.** Auf das Vertragsverhältnis findet ausschließlich deutsches Recht Anwendung.
- 3.** Angebote sind freibleibend und verpflichten uns nicht zur Auftragsannahme.
- 4.** Die durch unsere Vertreter getroffenen Vereinbarungen und mündlichen Absprachen erhalten erst durch unsere schriftliche Bestätigung Rechtsverbindlichkeit.
- 5.** Liefertermine werden nach Möglichkeit eingehalten. Verzögerungen in der Lieferung berechtigen nicht zu Schadenersatzansprüchen. Teillieferungen können durchgeführt werden. Ereignisse höherer Gewalt oder Betriebsstörungen entbinden uns von unserer Lieferungsverpflichtung. Schadenersatzansprüche des Käufers wegen Lieferverzug sind ausgeschlossen. Der Käufer ist nicht berechtigt, vom Vertrag zurückzutreten, ohne eine angemessene Liefernachfrist zu setzen.
- 6.** Die Lieferung erfolgt ab Werk auf Rechnung und Gefahr des Empfängers. Bei Anlieferung mit unseren LKWs innerhalb Deutschlands berechnen wir einen Frachanteil in Höhe von 6% des Warenwertes.
- 7.** Technische Änderungen behalten wir uns vor.
- 8.** Beanstandungen können nur berücksichtigt werden, wenn sie uns innerhalb 8 Tagen nach Lieferung schriftlich mitgeteilt worden sind. Für Beschädigungen auf dem Transport wird grundsätzlich kein Ersatz geleistet. Rücksendungen werden nur nach vorheriger Vereinbarung anerkannt. Für nachweislich mangelhafte Lieferung wird kostenloser Ersatz gewährt. Weitergehende Ansprüche jeder Art sind ausgeschlossen.
- 9.** Unsere Rechnungen sind zahlbar in Euro innerhalb 8 Tagen nach Rechnungsdatum in bar abzüglich 2% Skonto, oder innerhalb 30 Tagen in bar ohne Abzug. Schecks oder Wechsel gelten erst mit der Einlösung als Barzahlung. Bei Überschreiten der Zahlungsfrist berechnen wir 4% über dem jeweiligen Diskontsatz als Verzugszinsen oder Diskontspesen. Kommt der Besteller mit einer Zahlung in Verzug, so werden alle anderen Forderungen sofort zur Zahlung fällig, ohne dass es einer gesonderten Inverzugsetzung bedarf. Die Aufrechnung mit Gegenforderungen des Bestellers ist für alle denkbaren Fälle ausgeschlossen, es sei denn, die Gegenansprüche sind unbestritten oder rechtskräftig festgestellt.
- 10.** Für Lieferungen und Leistungen an Besteller im Ausland gilt als ausdrücklich vereinbart, dass alle Kosten der Rechtsverfolgung durch den Lieferanten im Falle des Zahlungsverzuges des Bestellers, sowohl gerichtliche als auch außergerichtliche, zu Lasten des Bestellers gehen.
- 11.** Wir behalten uns für den jeweiligen Kaufvertrag das Eigentum an der gelieferten Ware bis zur völligen Bezahlung des Kaufpreises einschließlich Zinsen und Kosten und bis zur völligen Einlösung der hierfür gegebenen Wechsel und Schecks vor.
- 12.** Die Fa. WOFI LEUCHTEN ist berechtigt, ihre Forderungen aus Lieferungen und Leistungen zu Finanzierungszwecken abzutreten.
- 13.** Erweiterter und verlängerter Eigentumsvorbehalt: Bis zur Bezahlung aller Ansprüche aus der Geschäftsverbindung, einschließlich etwaiger Refinanzierungs- oder Umkehrwechsel, behalten wir uns das Eigentum an unseren Warenlieferungen, die nur im ordnungsgemäßen Geschäftsverkehr veräußert werden dürfen, vor. Das gilt auch dann, wenn einzelne oder unsere sämtlichen Forderungen in eine laufende Rechnung aufgenommen wurden und der Saldo gezogen und anerkannt ist. Durch eine evtl. Verarbeitung dieser Waren erwirbt der Käufer kein Eigentum an den ganz oder teilweise hergestellten Sachen; die Verarbeitung erfolgt unentgeltlich ausschließlich für den Verkäufer, der Eigentümer der neu hergestellten Sache wird. Der Käufer tritt hiermit die Forderung aus einem Weiterverkauf der Vorbehaltsware ab, und zwar insoweit, als die Ware verarbeitet ist. Er ist ermächtigt, die abgetretenen Forderungen so lange einzuziehen, wie er sein Zahlungspflicht gegenüber uns vertragsmäßig nachkommt. Der Käufer hat uns Zugriffe Dritter auf die unter Eigentumsvorbehalt gelieferten Waren oder die abgetretenen Forderungen sofort mitzuteilen.
- 14.** Jede Teillieferung gilt in Bezug auf Berechnung und Bezahlung, nicht aber hinsichtlich des Eigentumsvorbehaltes, als besonderes Geschäft.
- 15.** Nichteinhaltung der vereinbarten Zahlungsbedingungen oder sonst. Vertragsverletzungen geben uns das Recht unter vorheriger Ankündigung das Zurückbehaltungsrecht für sämtliche noch ausstehenden Lieferungen auszuüben oder Vorauszahlung zu verlangen oder von der Lieferungsverpflichtung ganz zurückzutreten.
- 16.** Erfüllungsort für Lieferung und Zahlung für beide Teile ist Meschede-Freienohl, Gerichtsstand für beide Teile ist Meschede.
- 17.** Die vorstehenden Bedingungen gelten als verbindlich, soweit nicht ausdrücklich schriftlich andere Vereinbarungen getroffen werden.

WOFI LEUCHTEN Wortmann & Filz GmbH

GENERAL TERMS AND CONDITIONS OF SALE

- 1.** These General Terms and Conditions of Sale apply to all our current and future supply agreements. The customer shall be deemed to have accepted our terms no later than the point at which the goods are received and accepted. Any purchase, supply and payment terms of the ordering party that do not match our own sales terms shall be regarded as invalid. All previous terms and conditions and agreements shall expire on issue of the 2018 WOFI LEUCHTEN catalogue.
- 2.** The contractual relationship shall be subject exclusively to German law.
- 3.** All offers made by WOFI are subject to change without notice and do not constitute an obligation to accept specific orders.
- 4.** Agreements and oral understandings entered into by our representatives only acquire legally binding force when confirmed by us in writing.
- 5.** We make every effort to comply with supply deadlines. Supply delays do not confer an entitlement to compensation. An order may be supplied by means of partial deliveries. Our obligation to deliver may be suspended by incidents of force majeure or operational disruption. The purchaser may not claim compensation for delays in delivery. The purchaser may not cancel the agreement without granting us a suitable extension period in which to supply the goods.
- 6.** Deliveries are made ex factory for the account and at the risk of the recipient. Where the goods are delivered using our own HGV transport within Germany, we shall add a further 6% of the value of the goods to cover shipping.
- 7.** We reserve the right to make technical changes.
- 8.** Complaints can only be considered if they are submitted to us in writing within eight days of delivery. Under no circumstances will we provide replacements for any goods damaged in transit. Goods returned will only be accepted by prior agreement. Replacement goods will be provided free of charge where there is adequate evidence of a faulty delivery. No other claims of any kind will be considered.
- 9.** Our invoices are payable either within 8 days of the invoice date in cash less a discount of 2% or within 30 days in cash without a discount. Cheques and bills of exchange will only be regarded as cash payment once they have been paid out. We will charge 4% above the current discount rate by way of default interest or discount charges on all delayed payments. Once a single invoice falls overdue for payment, all other amounts owed by that customer shall automatically fall due for immediate payment without a requirement for us to issue a specific default notice. The Customer may not under any foreseeable circumstances offset any of its own claims against the amounts it owes unless those claims are either uncontested or legally established.
- 10.** In the case of deliveries made to foreign customers it is expressly agreed that all legal and other costs incurred by the supplier in seeking legal recourse following non-payment of invoices by the customer shall be paid by the ordering party.
- 11.** For each supply agreement, we reserve title to the goods delivered until they have been paid for in full including any interest and costs and up to the complete discharge of any bills or cheques used as payment.
- 12.** Where required for financing purposes, WOFI LEUCHTEN is entitled to assign to a third party its own claims to payment for the goods and services it has supplied.
- 13.** Extended reservation of title. We reserve title to all the goods we supply until we have received full payment for all amounts owed to us from the business transaction including any refinancing or acceptor's bills used. The goods may only be sold in the ordinary course of business. This reservation shall also apply where individual amounts owed to us or our entire claims have been included in a running account and a statement has been produced and the balance accepted. Any further processing of the goods shall not confer a right of title to the partially or fully produced new items; the processing shall be undertaken free of charge exclusively on behalf of the seller who shall acquire title to the newly produced item. The purchaser hereby assigns to us, to the extent that the goods have been reworked, its own claims for payment following any resale of the reserved title goods. The purchaser is entitled to collect the amounts corresponding to these reassigned claims for as long as it meets its own contractual obligation to pay us. The purchaser must inform us immediately of any attempts by third parties to obtain the reserved title goods or the reassigned claims.
- 14.** Each partial delivery shall be considered as a separate transaction with regard to invoicing and payment but not with regard to reservation of title.
- 15.** Where the customer fails to comply with agreed payment terms or with other provisions of the agreement, we shall be entitled, subject to our giving prior notice, to withhold all outstanding deliveries or demand advance payment or withdraw entirely from our obligation to supply the goods in question.
- 16.** For both parties, the place of fulfilment for supply and payment shall be Meschede-Freienohl. The place of jurisdiction for both parties shall be Meschede.
- 17.** The above terms and conditions are binding in the absence of any other expressly written terms agreed between the parties.

WOFI LEUCHTEN Wortmann & Filz GmbH

KONTAKT CONTACT

Gerne begrüßen wir Sie in unserem Showroom.
Pleased to meet you in our showroom.

Vertriebskontakt / Sales Contact

Möchten Sie den Vertriebsinnendienst erreichen verwenden Sie bitte die bekannte Durchwahl.

If you would like to get hold of the Sales Department please dial the known extension.

Service / Service

WOFI-Kundendienst

Postfach 3271
D - 59861 Meschede-Freienohl

phone +49 (0) 2903 449 449
fax +49 (0) 2903 449 459
email kundendienst@wofi.de
web www.wofi.de

Zentrale / Phone reception

Wortmann & Filz GmbH

Im Langel 6
D - 59872 Meschede-Freienohl

phone +49 (0) 2903 449 0
fax +49 (0) 2903 449 114
email info@wofi.de
web www.wofi.de

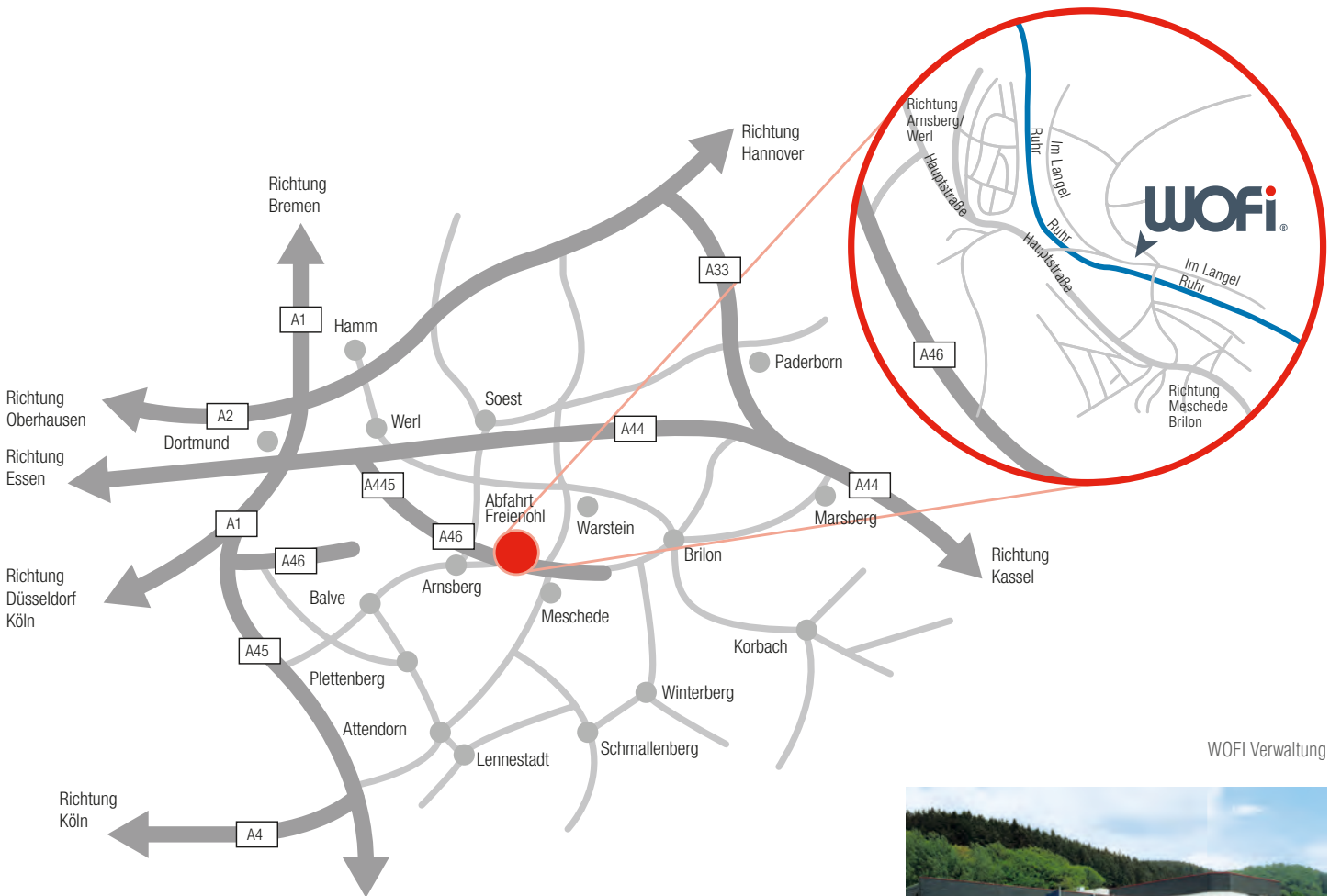

WOFI Verwaltung



WOFI Logistik-Zentrum

Oder besuchen Sie unsere Internetseite unter www.wofi.de.
Or visit our website under www.wofi.de.



ZEICHENERKLÄRUNG / SIGNS & SYMBOLS

					
GU10 Sockel	GU10 base	Douille GU10	Base GU10	Cokół GU10	цоколь GU10
 Reflektorlampe Ø 50 mm, mit aluminium-beschichtetem Reflektor Sockel GU10 / GZ10	Reflector lamp Ø 50 mm, with aluminiumcoated reflector GU10 / GZ10 base	Ampoule de réflecteur Ø 50 mm, à réflecteur recouvert d'aluminium, Douille GU10 / GZ10	Lámpara de reflector Ø 50 mm, con reflector revestido de aluminio, base GU10 / GZ10	Żarówka projektorowa Ø 50 mm, z reflektorem o aluminiowej powłoce, Cokół GU10 / GZ10	рефлекторная лампа Ø 50mm, с рефлектором с алюминиевым покрытием, цоколь GU10/GZ10
G9 Sockel	G9 base	Douille G9	Base G9	Cokół G9	цоколь G9
 Kapselform	Capsule shape	Forme de capsule	Lámpara en forma de cápsula	Żarówka w formie kapsułki	форма капсулы
E14 Sockel	E14 base	Douille E14	Base E14	Cokół E14	цоколь E14
 Kerzenlampe	Candle lamp	Ampoule flamme	Lámpara en forma de vela	Żarówka w formie Świecy	лампа в форме свечи
 Tropfenlampe	Dropform lamp	Ampoule goutte	Lámpara en forma de gota	Żarówka w formie kropli	каплеобразная лампа
 Röhrenform	Tubular shape	Forme tube	Lámpara en forma de tubo	Żarówka w formie rury	трубчатая форма
E27 Sockel	E27 base	Douille E27	Base E27	Cokół E27	цоколь E27
 Allgebrauchslampe	General lighting service lamp	Ampoule standard	Lámpara de uso universal	Żarówka do ogólnego użytku	лампа универсального применения
 Globelampe	Globe lamp	Ampoule à globe	Lámpara en forma de globo	Żarówka w formie kuli	шарообразная лампа
LED	LED	LED	LED	LED	светодиодная лампа
 Eingebaute LEDs	Built-in LED lamps	LED intégrée	Lámparas LED incorporadas	Wbudowane lampy LED	встроенные светодиодные лампы

FARBSCHLÜSSEL / COLOUR KEY



01	Chrom	Chrome	Chrome	Cromo	Chrom	хромированный
02	Messing gefärbt	brass coloured	imitation laiton	Latón-teñido	Mosiądz zafarbowany	цветная латунь
05	Kolonialstil braun	Colonial style brown	style colonial marron	Marrón colonial	Brązowy kolonialny	коричневый в колониальном стиле
06	Weiß	White	Blanc	Blanco	Biały	белый
09	Antik braun	Antique brown	Antique brune	Color tostado	Rdzawy	под ржавчину
10	Schwarz	Black	Noir	Negro	Czarny	чёрный
13	Goldfarbig	Gold coloured	Or coloré	Dorado	Złoty	бежевый
15	Goldfarbig	Gold coloured	Or coloré	Dorado	Złoty	бежевый
23	Braun	Brown	Marron	Tostado	Brązowy	коричневый
29	Blau	Blue	Bleu	Azul	Niebieski	голубо й
32	Messing-matt	Brass matt finished	Laiton mat	Latón-mate	Mosiądz matowy	матовая латунь
46	Schwarz Gold	Black Gold	Noir Or coloré	Negro Dorado	Czarno Złoty	чёрный бежевый
50	Grau	Grey	Gris	Gris	Szary	серый
51	Ahorn natur	Nature maple	érable naturel	Arce natural	klon naturalny	кленово-коричневый
52	Braun	Brown	Marron	Tostado	Brązowy	коричневый
54	Nickel-matt/Chrom	Nickel matt finished/ Chrome	Nickel mat/ chrome	Níquel-mate/cromo	Stal matowa/chrom	матовое железо/хром
57	Antik braun Messing-gefärbt	Antique brown Brass coloured	Antique brune Imitation laiton	Color tostado latón-teñido	Rdzawy Mosiądz zafarbowany	под ржавчину цветная латунь
58	Cappuccino	Cappuccino	Cappuccino	Capuccino	Cappuccino	капучино
63	Aluminium gebürstet	Aluminium brushed finished	En couleur nickel	Aluminio satinado	Aluminium	матовый алюминий
64	Nickel-matt	Nickel matt finished	Nickel mat	Níquel-mate	Stal matowa	матовое железо
70	Silber	Silver	Argent	Plata	Srebrny	серебряный
76	Nickel-matt eloxiert	Nickel-matt finished anodised	Nickel mat oxydé	Níquel mate, anodizado	Nikiel mat anodowany	анодированное матовое железо
79	Rostfarbig	rust coloured	rouille coloré	Color óxido	rdza kolorowe	ржавоцветной
88	Anthrazit	dark grey	anthracite	antracita	antracyt	тёмно-с рый
94	Rosa	Pink	Rose	Rosa	różowy	розовый
97	Edelstahl gebürstet roh	stainless steel brushed	acier brossé	Acero inoxidable	Stal szcztokowana	матовая высококачественная сталь



Unsere Produkte erfüllen die grundlegenden Sicherheitsanforderungen, die in den EU-Richtlinien definiert sind.

Our products fulfill the basic safety requirements that are defined in the EU regulations.



Unsere Produkte werden durch den TÜV Rheinland oder dem VDE Prüfinstitut in jährlich wiederkehrenden Werksprüfungen begutachtet.

Our products are examined by the TÜV Rheinland or the VDE Test Institute in an annual factory test.



WOFI Designs sind grundsätzlich als Geschmacksmuster geschützt. Nachahmungen werden gerichtlich verfolgt.

WOFI Designs are strictly protected as design patent. Imitations will be prosecuted.



*online
unter
wofi.de*

*info@
wofi.de*



WOFI[®]