



GROK
by LEDS-C4

GROK

by LEDS-C4

INNOVATION
AREA



MEDITERRA
Cosmopolitan





NEARBY

Cosmopolita

NEO *Contrast*

Cercano

Mediterranean

Contraste

Multicultural

NATURAL

GROK

by LEDS-C4



“ A cocktail of authenticity, elegance and personality.

Un cóctel de autenticidad, elegancia y personalidad.”

Designers



Benedito Design

“The use of beauty
La utilidad de la belleza.”



Estudi Ribaudí

“We beautify and simplify our surroundings to
improve the everyday life.
Embellecemos y simplificamos nuestro entorno para
mejorar el día a día.”



Francesc Vilaró

“Moulding the light allows us to design the
context creating unique spaces and environments.
Modelar la luz nos permite diseñar el contexto
creando espacios y ambientes únicos.”



Gemma Bernal

“As a designer I tend to propose useful, simple and
warm objects.
Como diseñadora trato de proponer objetos útiles,
simples y amables.”



Jordi Llopis

“The power of the look to become real objects.
La fuerza de la mirada para convertirla en objetos
reales.”



Josep Patsí

“When art and technique come together.
Cuando arte y técnica se encuentran.”



Llusà & Santolaria

“We design and create to improve our today and
our tomorrow.
Diseñamos y creamos para mejorar nuestro hoy y
nuestro mañana.”



Nahtrang Disseny

“Working with light is a challenge. Obtaining a great
result is magic.
Trabajar la luz es un reto. Obtener un buen resultado es
mágico.”



Ramón Valls

“A little bit more is always possible.
Un poco más casi siempre es posible.”



WIS Design

“Wisdom and poetry for everyday objects.
Sabiduría y poesía para los objetos cotidianos.”

Index

/10

colgantes
pendants
suspensions
pendelleuchten
pendenti
pendentes
подвесные светильники
lampy wiszące



Alive 30



Angie 58



Aura 68



Balloons 104



Bamboo 48



Blomma 110



Circ 72



Clear 94



Emy 120



Hello 44



Invisible 16



Iris 114



Leaf 66

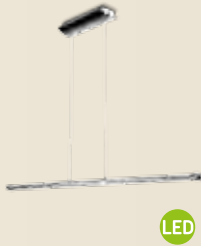

Ledagio 100



Leila 128



Linear 123



Net 86



Rigatto 26



Ringfire 82



Siluet 122



Sixties 62



Sky 116



Slimm 125



Spin 126



Stream 80



Talk 40



Tandem 90



Troppo 124



Tulip 102



Twins 108



Umbrella 96



Vintage 52

apliques
 wall fixtures
 appliques
 wandleuchten
 lampade da parete
 apliques
 настенные светильники
 lampy ścienne

/11



Bend 172

Bigbang 146

Cell me 162

Emy 190



Eos 158

Flap 136

Flat 182

Hall 194

Ibis 230

Invisible 150



Ledbox 178

Lov 184

Mirror 206

Nemo 244

New Hotels 188



Open 202

Rizz 132

Skata 170

Slimm 176

Stream 160



Suite 192

Suite 204

Supple 200

Surf 154

Talk 138



Vintage 140

Wave 132

/ 12

plafones
ceiling fixtures
plafoniers
deckenleuchten
plafoniere
plafones
ПОТОЛОЧНЫЕ СВЕТИЛЬНИКИ
lampy sufitowe

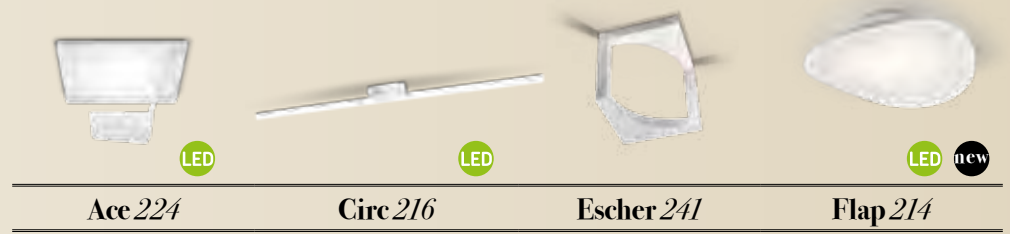

Ace 224

Circ 216

Escher 241

Flap 214



Ibis 230

Ledbox 246

Nemo 244

Net 226

Ocho 238

Ona 323

Rigatto 210



Single 218

Six 220

Spin 242

Tandem 234

Traç 236

Troppo 240

sobremesas
table lamps
lampes de table
tischleuchten
lampade da tavolo
candeeiros de mesa
НАСТОЛЬНЫЕ СВЕТИЛЬНИКИ
lampy biurkowe



Blomma 264

Emy 266

Hall 258



Iris 267

Medusa 260

New Hotels 256

Open 272

Premium 252



Supple 270

Sway 268

Talk 250

pies salón
 floor lamps
 lampadaires
 stehleuchten
 lampade da terra
 candeeiros de sala
 торшеры
 lampy podłogowe

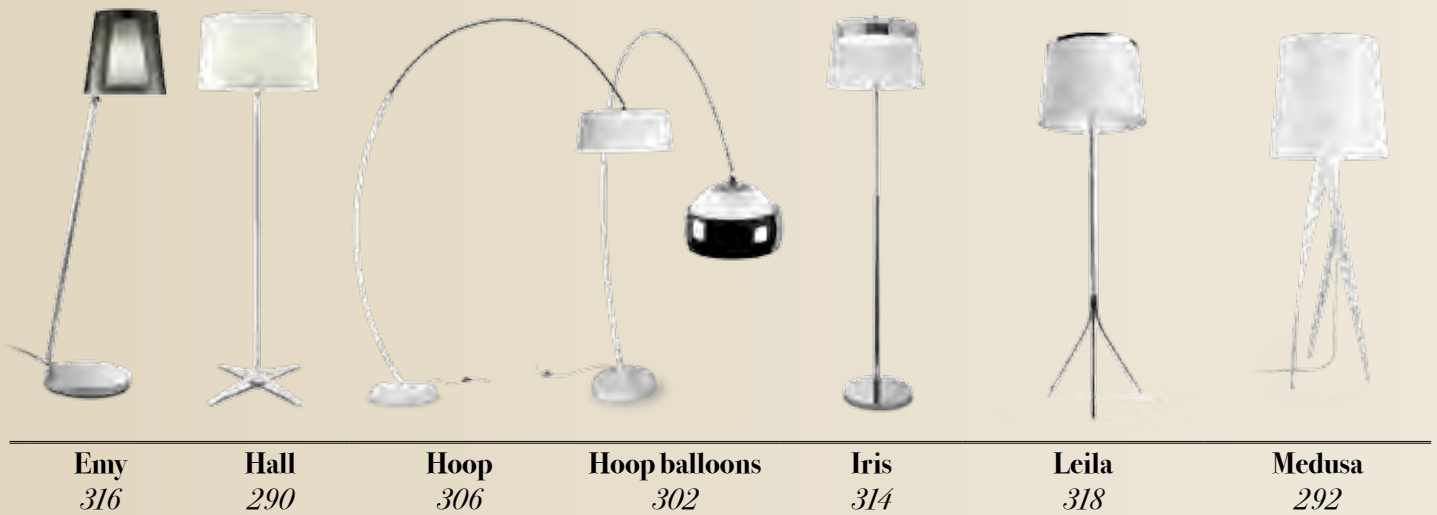

Pendants



Invisible

p.16



Rigatto

p.26



Alive

p.30



Talk

p.40

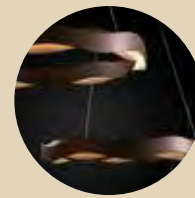

Hello

p.44



Bamboo

p.48

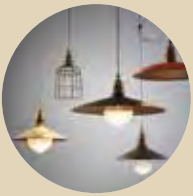

Vintage

p.52

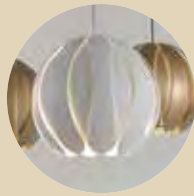

Angie

p.58



Sixties

p.62



Leaf

p.66



Aura

p.68



Circ

p.72



Stream

p.80

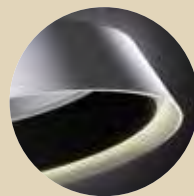

Ringofire

p.82



Net

p.86



Tandem

p.90



Clear

p.94



Umbrella

p.96

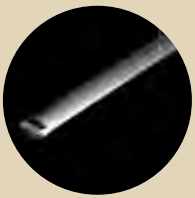

Ledagio

p.100

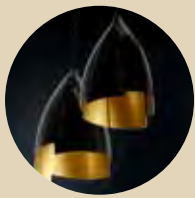

Tulip

p.102



Balloons

p.104



Twins

p.108



Blomma

p.110



Iris

p.114



Sky

p.116



Emy

p.120



Siluet

p.122



Linear

p.123

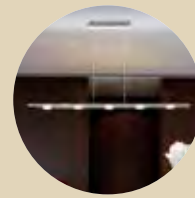

Troppo

p.124



Slimm

p.125



Spin

p.126



Leila

p.128



Invisible new

design Francesc Vilaró



Invisible

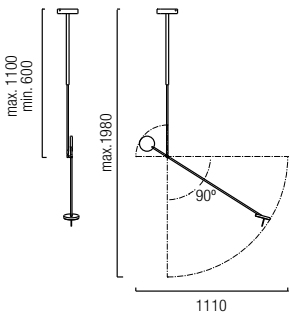
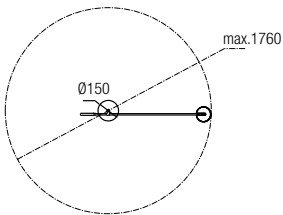
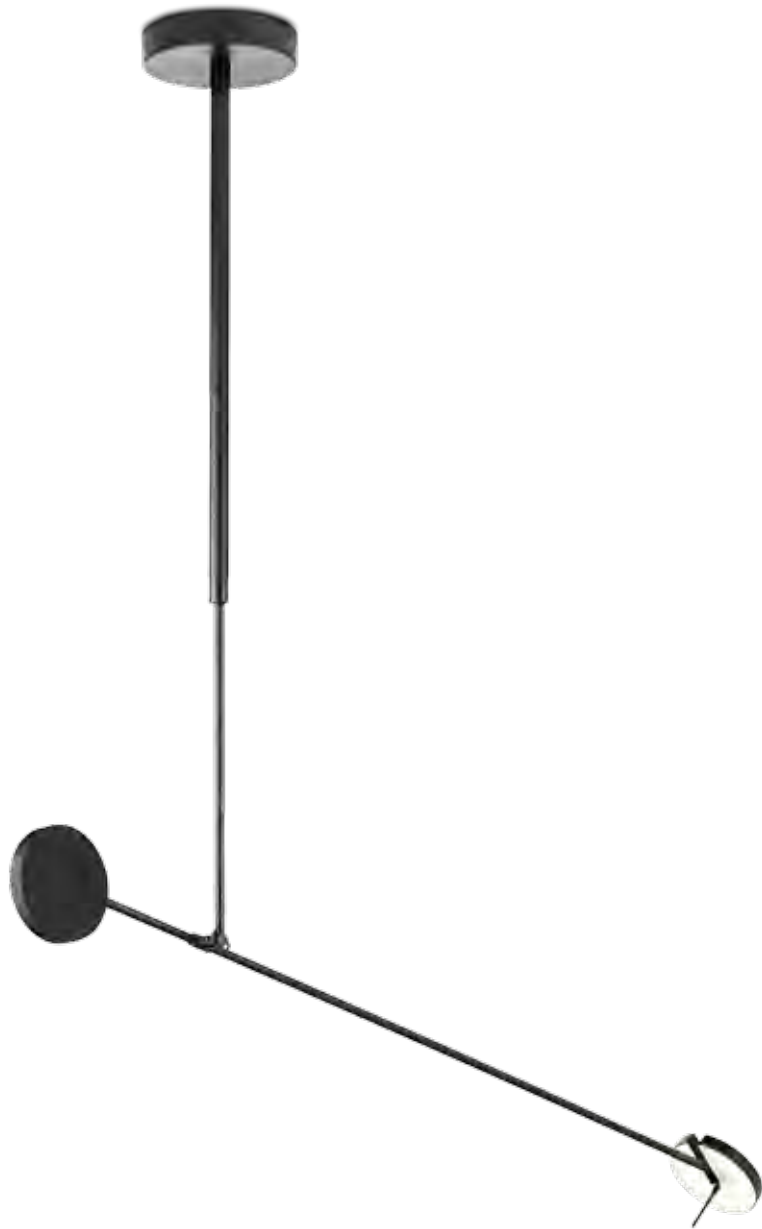

00-5459-05-05

LED 9W A++ A
765 lm 3000K

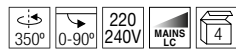



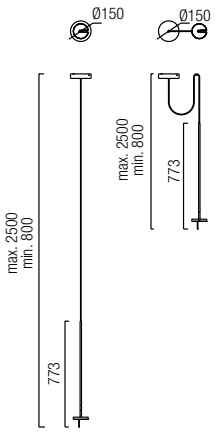

00-5460-05-05

LED 9W A++ A
765 lm 3000K

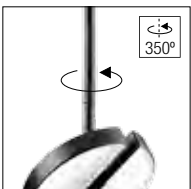
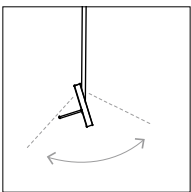

Invisible

/21









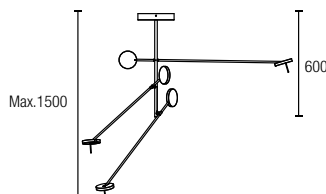
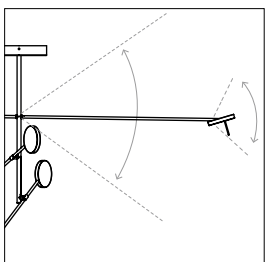
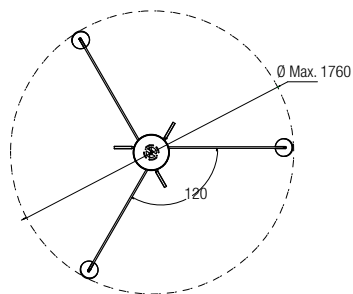

00-5079-05-05 (Standard) $\begin{matrix} 100 \\ 240V \end{matrix}$
 00-5084-05-05 (Mains dimming)* $\begin{matrix} 220 \\ 240V \end{matrix}$

LED 27W A++ A
 2295 lm 3000K





Rigatto new

design Gemma Bernal

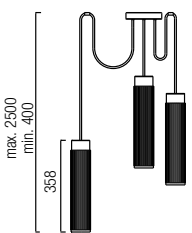
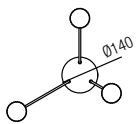
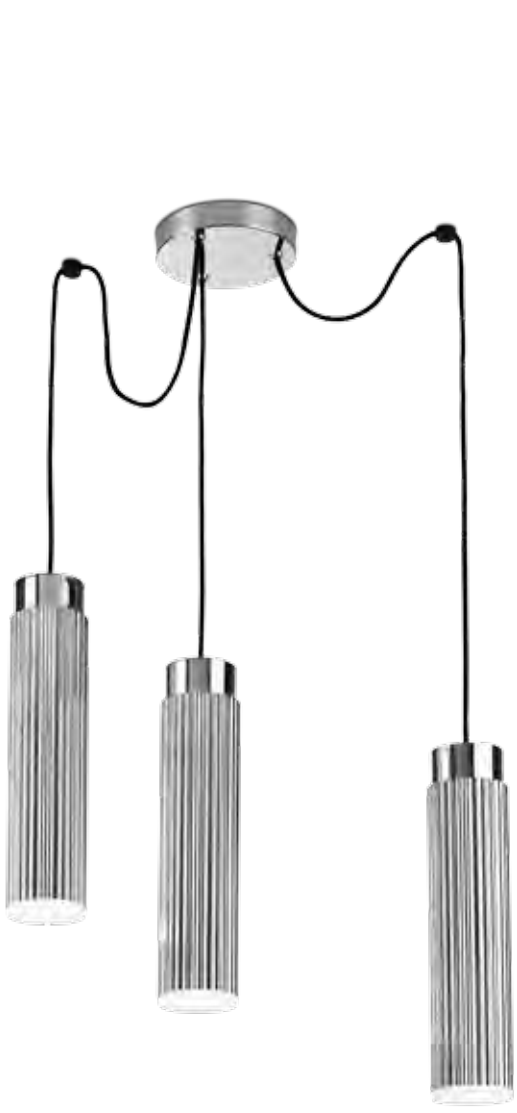

00-5278-21-21 2700K
00-5278-BW-BW 2700K
00-5494-BW-BW 3000K

3 x LED CREE 21,6W A++ A
 2.325 lm

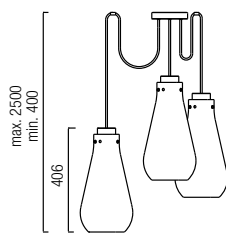
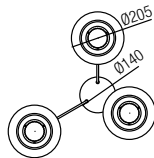

00-5279-21-37 2700K
00-5279-BW-37 2700K
00-5495-BW-37 3000K

3 x LED CREE 21,6W A++ A
 2.325 lm



21 BW

AL ST PMMA DIF

⏚ e 220 240V MAINS Lc RF 650 R CE W Light





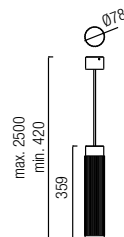

- 00-5280-21-21** 2700K
- 00-5280-BW-BW** 2700K
- 00-5496-BW-BW** 3000K

LED CREE 7,2W A++ A
775 lm

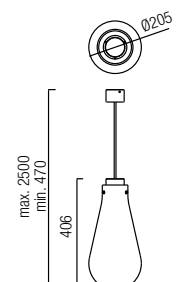

- 00-5281-21-37** 2700K
- 00-5281-BW-37** 2700K
- 00-5497-BW-37** 3000K

LED CREE 7,2W A++ A
775 lm





Alive ^{new}

design Fransesc Vilaró



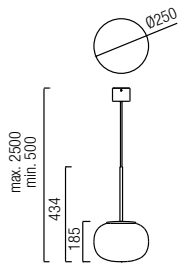
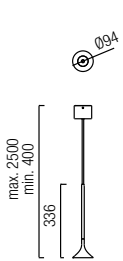

00-5284-21-21
00-5284-BW-BW

LED CREE 7W A++ A
 612 lm 2700K



00-5285-21-F1
00-5285-BW-F1

LED CREE 7W A++ A
 612 lm 2700K



21 BW

AL ST PMMA
 DIF



Alive

/33





Alive

/35

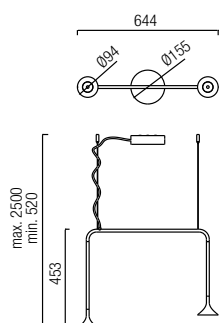

00-5286-21-21
00-5286-BW-BW

2 x LED CREE 14W A++ A
1224 lm 2700K

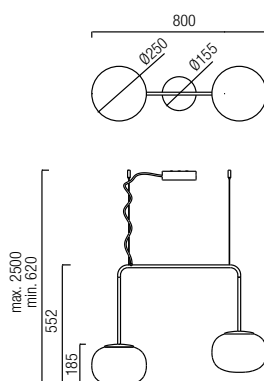

00-5287-21-F1
00-5287-BW-F1

2 x LED CREE 14W A++ A
1224 lm 2700K



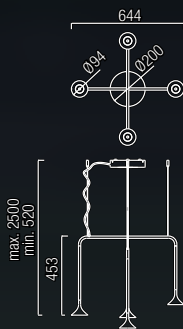

00-5288-21-21
00-5288-BW-BW

4 x LED CREE 28W A++ A
2448 lm 2700K

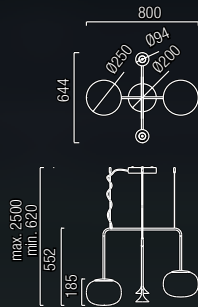

00-5289-21-F1
00-5289-BW-F1

4 x LED CREE 28W A++ A
2448 lm 2700K

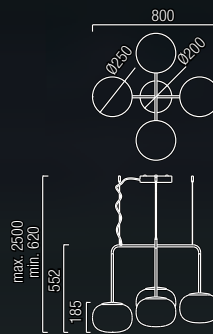

00-5290-21-F1
00-5290-BW-F1

4 x LED CREE 28W A++ A
2448 lm 2700K





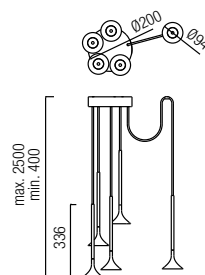
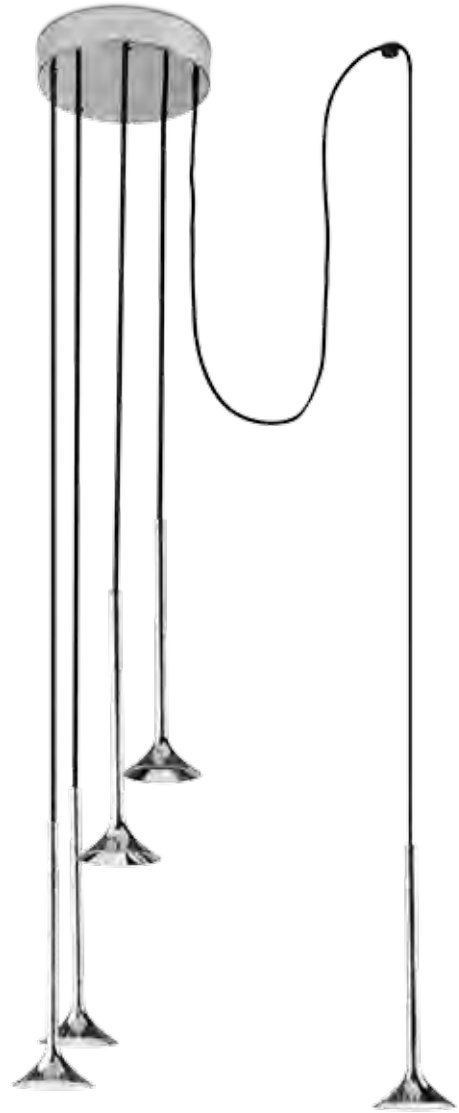

00-5291-21-21
00-5291-BW-BW

5 x LED CREE 35W A++ A
3060 lm 2700K



Alive

/39



NOVATION
AREA



Talk^{new}

design Nahtrang Disseny



/42

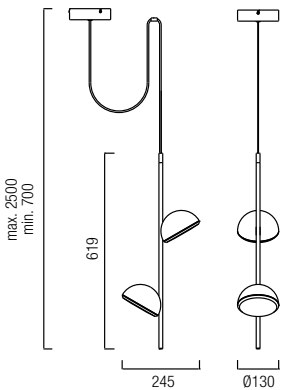
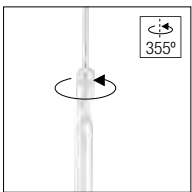

00-5457-BW-F9
00-5457-Z5-F9

2 x LED CREE 13W A++ A
1.390 lm 2700K

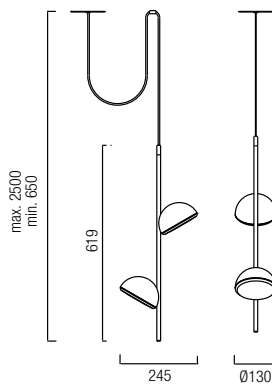

00-5458-BW-F9
00-5458-Z5-F9

2 x LED CREE 13W A++ A
1.390 lm 2700K

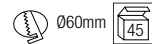

BW **Z5**

AL ST GLASS
DIF

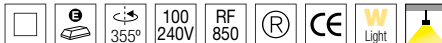

Talk

/43





Hello new

design Josep Patsí





Hello

/47

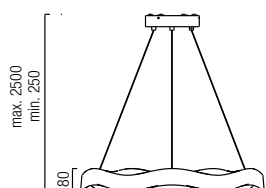
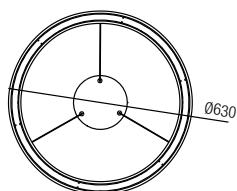

00-5275-BW-M1	2700K
00-5498-BW-M1	3000K
00-5275-CT-M1	2700K

LED 24,3W A++ A
2.300 lm

BW CT

ST PUR PMMA
DIF





Bamboo

design Gemma Bernal



Bamboo

Bambú
Bamboo
Bambou
Bambus
Bamboo
Bambu
Бамбук
Bambus

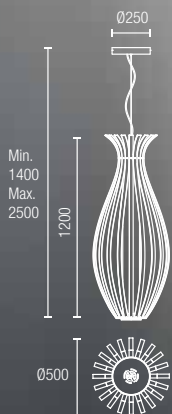

00-4034-CT-93 (Dimmable 1-10V)

LED 22W A++ A
1870 lm 3000K





• COFFEE •	
espresso	• 1,50
macchiato	• 1,50
espresso	• 1,50
latte macchiato	• 1,50
moka espresso	• 1,50

• FRAPPE •	
frutta, caffè	• 2,50
mela, yogurt	• 3,50

Vintage

design Lluscà & Santolaria

Vintage

/54





/56



Vintage

/57

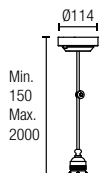

71-4820-50-50V1

LED Cree 8,3W A++ A
914 lm 3000K



71-4821-CU-CU

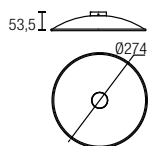

71-4824-20-20
71-4824-CI-CI

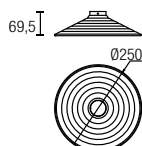

71-4940-CI-CI

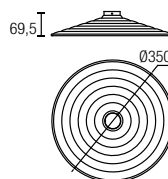

71-4825-CI-CI

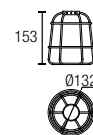

Su especial diseño permite múltiples combinaciones.
Its special design allows for multiple combinations.



71-4817-F1-F1

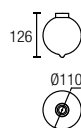

71-4818-F1-F1

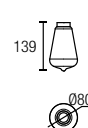

Combinaciones / Combinations

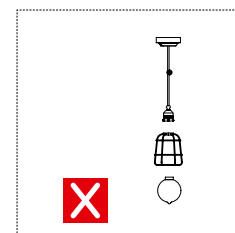
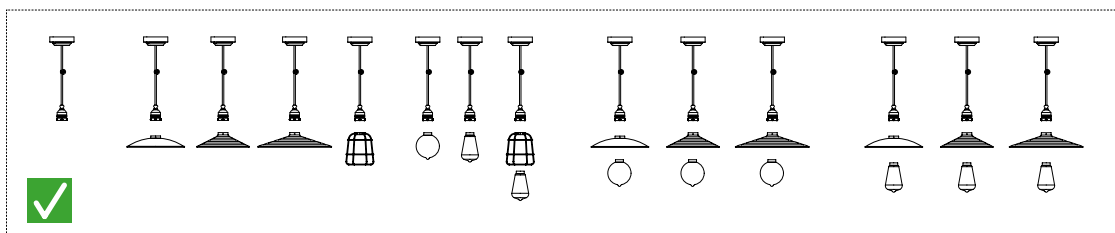

50 20 CI CU

ST AL GLASS DIF

100 240V R CE

140

Angie

design Josep Patsí

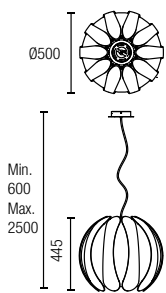

00-3543-BW-BW
00-3543-F5-F5

1 x E-27 Max. 100W / Max.L=200mm. Ø=150mm A++ c
Halogen - Fluorescent - LED

BW F5

ST PMMA ABS





Angie

/61





Sixties

/63

design Josep Patsí



Ø220

Max
2500
Min
400

00-3806-CI-CIV1

LED CREE 27W A++ A
2.970 lm 3000K



ST



Sixties

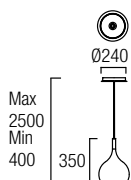

00-3687-CI-CIV1

LED CREE 9W A++ A
990 lm 3000K

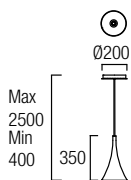

00-3688-CI-CIV1

LED CREE 9W A++ A
990 lm 3000K

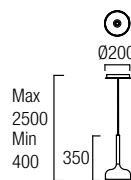

00-3689-CI-CIV1

LED CREE 9W A++ A
990 lm 3000K



/66

Leaf

design WIS Design

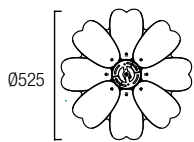

Ø525

Max 2000
Min 600

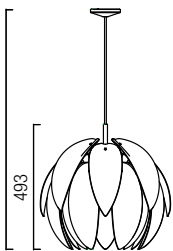

493

00-3813-BW-08
00-3813-BW-34

1 x E-27 Max. 30W / Max.L=176mm. A++ A
Fluorescent-LED

BW 08 34

ST PMMA FELT
SHADE



Aura

design Josep Patsí



/70

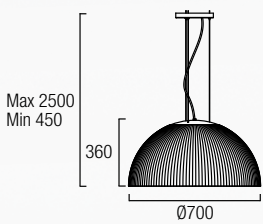
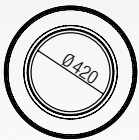

00-1942-BW-M3

LED 40W
3000K 3840 lm
LED 10W A++ A
RGB

equivalente a
as bright as
4x60W E-27 Halogen

--	----------	--	--



Sistema de doble iluminación independiente.
 Independent paired lighting system.
 Système à double éclairage indépendant.
 Unabhängiges doppeltes Beleuchtungssystem.
 Sistema a doppia illuminazione indipendente.
 Sistema de iluminação dupla independente.
 Система независимого двойного освещения.
 Niezależny łączony system oświetleniowy.



Circ

design Grok Team

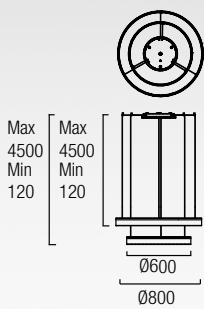

00-3647-BW-M3 (Standard)

LED 53W A++ A
5088 lm 3000K



equivalente a
as bright as
5x60W G9 ECO Halogen

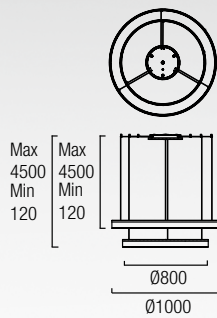

00-3648-BW-M3 (Standard)

LED 67W A++ A
6.432 lm 3000K



equivalente a
as bright as
7x60W G9 ECO Halogen

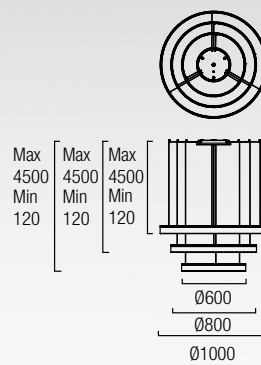

00-3649-BW-M3 (Standard)

LED 89W A++ A
8.544 lm 3000K

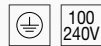

equivalente a
as bright as
9x60W G9 ECO Halogen



71-2241-00-00

Controlador con mando a distancia para
Versiones Standard
Controller with remote control for
Standard Version



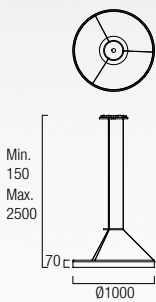

00-3642-BW-M3 (Standard)
00-3646-BW-M3 (Dimmable 1-10V)

LED 36W A++ A
 3.456 lm 3000K



equivalente a
 as bright as
 4x60W G9 Halogen

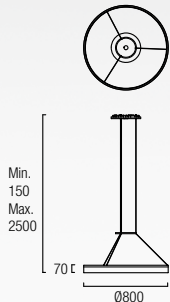

00-0002-BW-M3 (Standard)
00-0642-BW-M3 (Dimmable 1-10V)

LED 31W A++ A
 2.976 lm 3000K



equivalente a
 as bright as
 3x60W G9 Halogen

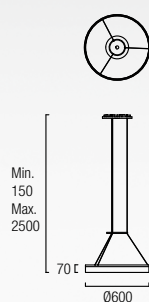

00-0001-BW-M3 (Standard)
00-0641-BW-M3 (Dimmable 1-10V)

LED 22W A++ A
 2.112 lm 3000K



equivalente a
 as bright as
 2x60W G9 Halogen



71-2241-00-00

Controlador con mando a distancia
 para **Versiones Standard**
 Controller with remote control for
Standard Version





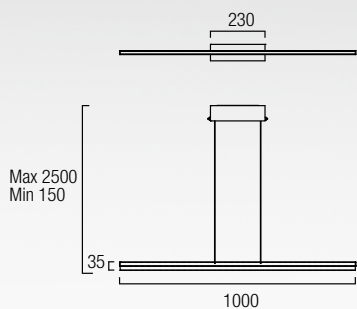
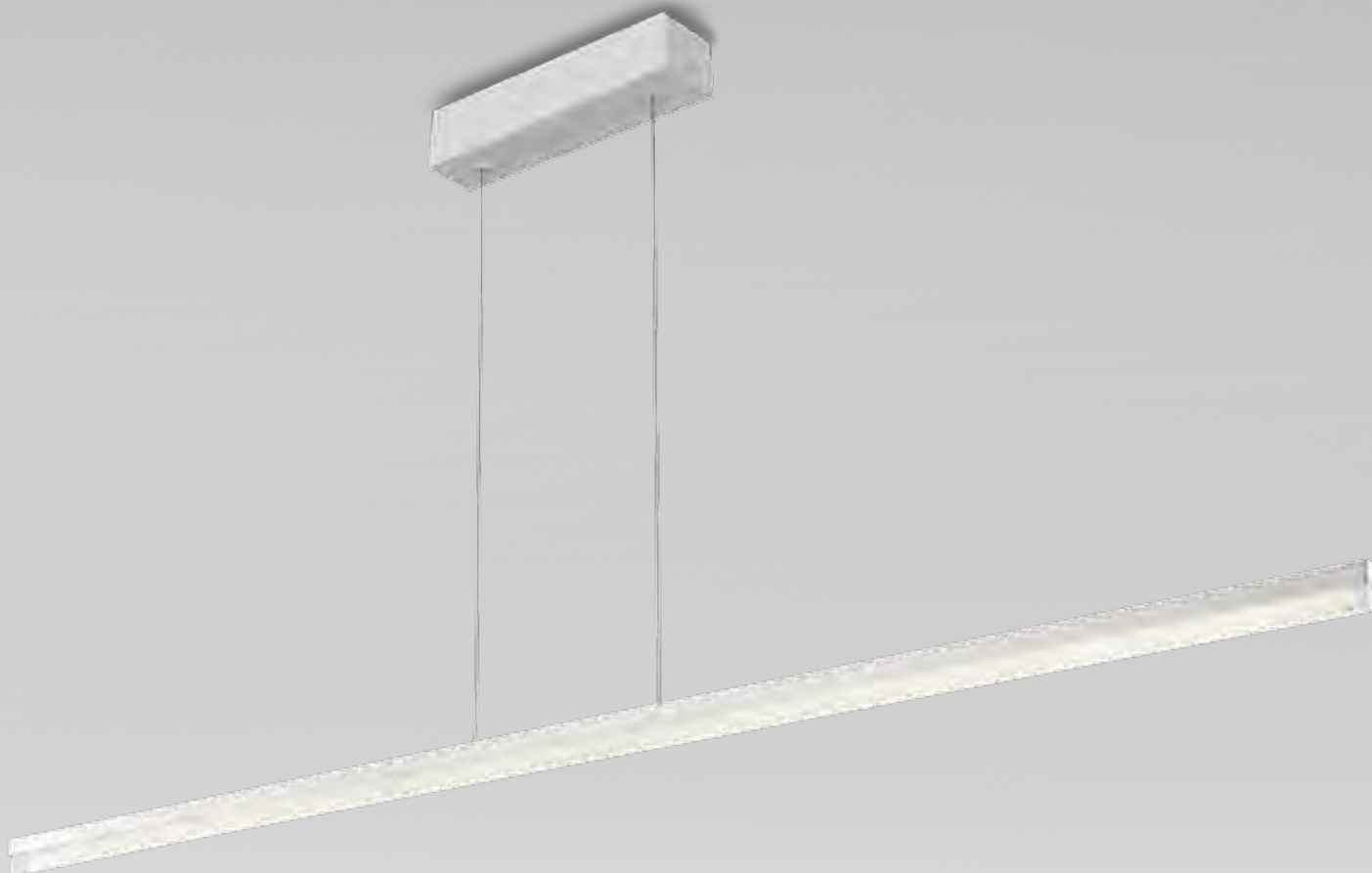

00-2934-BW-M3V1 (Standard)
00-3643-BW-M3V1 (Dimmable 1-10V)

LED 18W A++ A
 1.728 lm 3000K



equivalente a
 as bright as
 6x20W G9 ECO Halogen

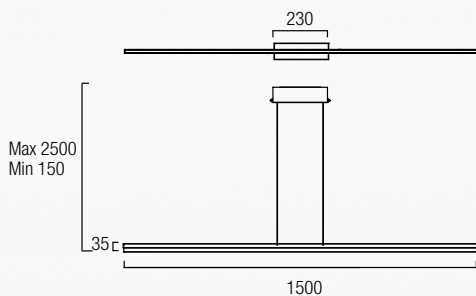

00-2935-BW-M3V1 (Standard)
00-3644-BW-M3V1 (Dimmable 1-10V)

LED 27W A++ A
 2.592 lm 3000K



equivalente a
 as bright as
 9x20W G9 ECO Halogen



71-2241-00-00

Controlador con mando a distancia para
Versiones Standard
 Controller with remote control for
Standard Version





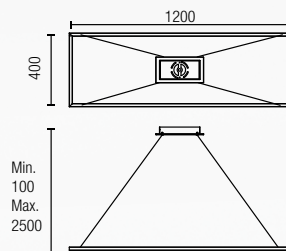

00-4876-BW-M3 ¹⁰⁰/_{240V}
00-4872-BW-M3 (Mains dimming) ²²⁰/_{240V}

LED 34W A++ A
 3.264 lm 3000K



equivalente a
as bright as
 11x20W G9 ECO Halogen



Stream

design Josep Patsí

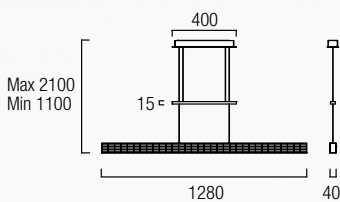
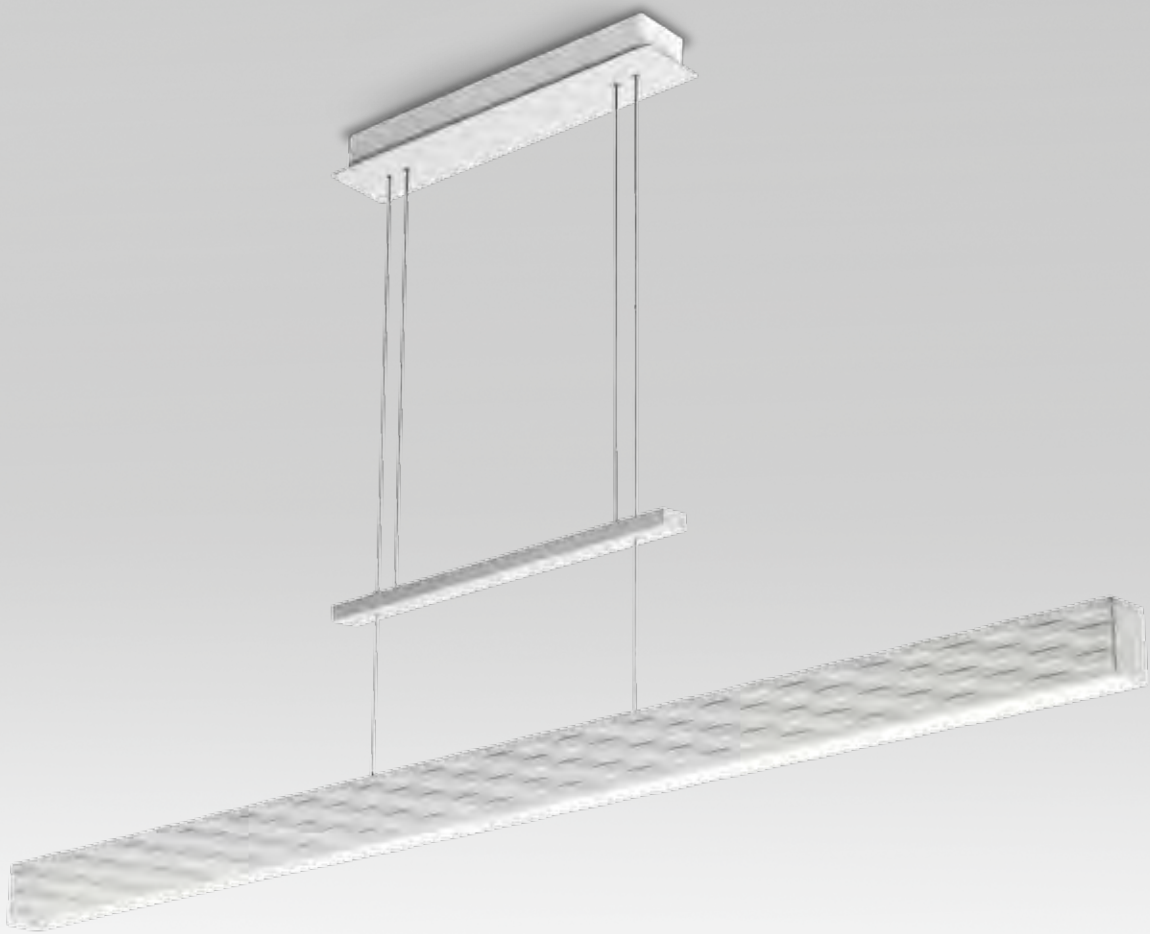

00-2924-BW-M1

LED 27,5W (Down) 2.640 lm
 LED 12,5W (Up) 1.200 lm A++ A
 3000K

equivalente a
 as bright as
 9x20W G9 ECO Halogen (down)

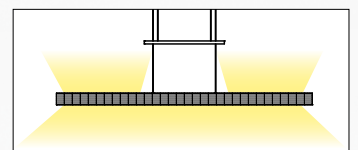

			<p>160</p>
--	--	--	------------

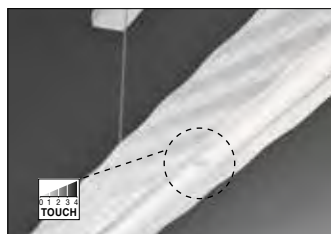
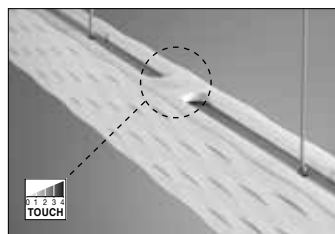
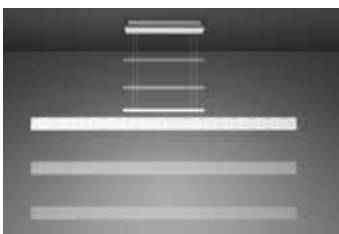

Sistema de doble iluminación independiente.
 Independent paired lighting system.
 Système à double éclairage indépendant.
 Unabhängiges doppeltes Beleuchtungssystem.
 Sistema a doppia illuminazione indipendente.
 Sistema de iluminação dupla independente.
 Система независимого двойного освещения.
 Niezależny łączony system oświetleniowy.

Ringofire

design Francesc Vilaró





Ringofire

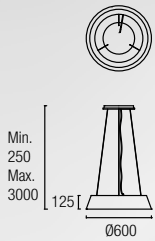

**00-0053-05-BW**

LED 26W A++ A
974 lm 3000K

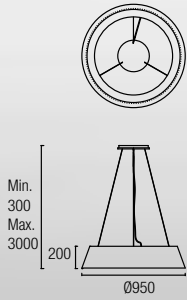
**00-0053-05-BW
+ 71-0053-BW-BW****00-0054-05-BW****00-0054-05-BW**

LED 41W A++ A
1536 lm 3000K

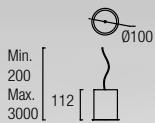
**71-0053-BW-BW**

1 x GU10 Max. 15W / Max. L= 100mm
Ø=111mm LED A++ C

Recommended:

ACT-FLL-015 10W 24°

ACT-FLL-017 10W 35°

ACT-FLL-032 15W 24°

ACT-FLL-033 15W 35°



Sistema de doble iluminación independiente
Independent double lighting system
Système double éclairage indépendant
Unabhängiges doppeltes Beleuchtungssystem
Sistema di doppia illuminazione indipendente
Sistema de dupla iluminação independente
Система независимого двойного освещения
Niezależny system podwójnego oświetlenia

05 BW**ST**

Net

design Josep Patsí



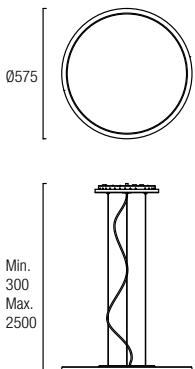
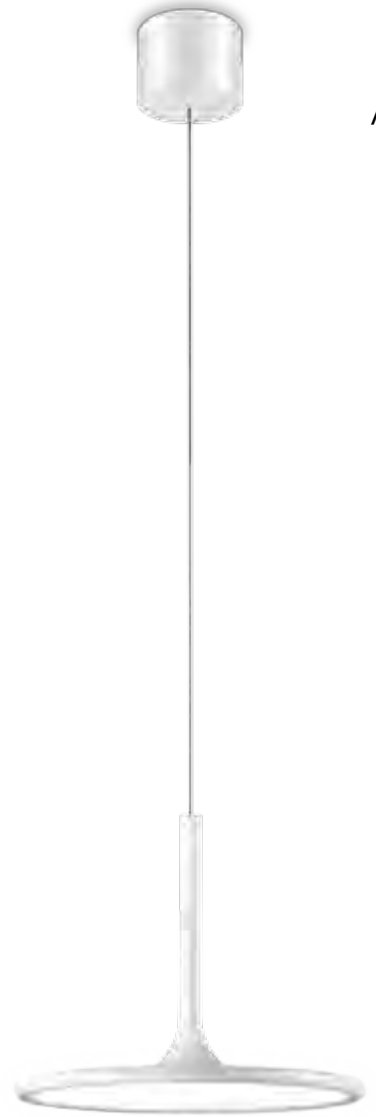

00-0003-BW-M1 (Standard)
00-0643-BW-M1 (Dimmable 1-10V)

LED 44W A++ A
 4.224 lm 3000K

**equivalente a
 as bright as**
 5x60W E-27 Halogen



71-2241-00-00

Controlador con mando a distancia para 00-0003
 Controller with remote control for 00-0003



00-3685-BW-M1

LED 15W A++ A
 1.440 lm 3000K

**equivalente a
 as bright as**
 4x20W G9 ECO Halogen

Max 1500
 Min 300

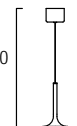

BW

AL PS
 DIF



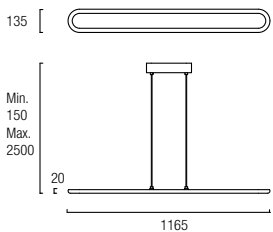

00-0779-BW-M1 (Standard)
00-0826-BW-M1 (Dimmable 1-10V)

LED 43W A++ A
 4.128 lm 3000K

equivalente a
 as bright as
 75x60W E-27 Halogen



71-2241-00-00

Controlador con mando a distancia para 00-0779
 Controller with remote control for 00-0779







Tandem

design Benedito Design





Tandem

/93

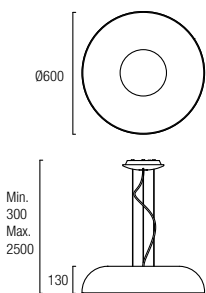

00-0056-BW-M1
00-0056-05-M1
 1 x 2GX13 40W + 1 x 2GX13 22W A++ B

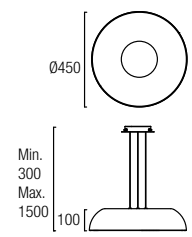

00-0778-05-M1
00-0778-BW-M1
 1 x 2GX13 55W A++ B

Clear

design Josep Patsí

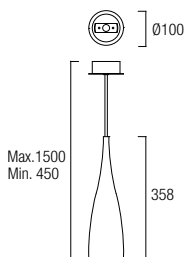

00-2872-05-M2
00-2872-25-M2
00-2872-78-M2

1x E-27/ Par-20 Max. 50W / Max. L=170mm Ø=64mm A++ c
Halogen - Fluorescent - LED
Recommended E-27 PAR-20 50W



71-2232-14-14



05 25 78

ST PC
DIF





Umbrella

design WIS design





Umbrella

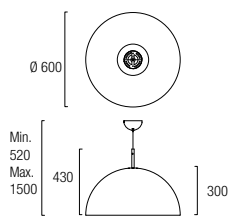

00-2727-AP-05
00-2727-AQ-78

3 x E-14 Max. 11W / Max. L=145mm Ø=45mm
A++ C
Fluorescent - LED

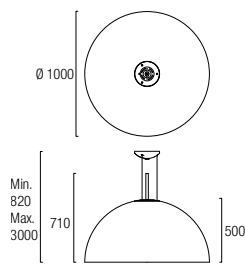

00-2726-AP-05
00-2726-AQ-78

3 x E-27 Max. 23W / Max. L=150mm Ø=60mm
A++ C
Fluorescent - LED





/100



Ledagio

design Josep Patsí

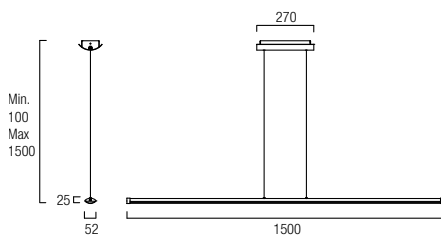

00-4425-21-M3

LED CREE 27W A++ A
2.300 lm 3000K

equivalente a
as bright as
8x20W G9 ECO Halogen

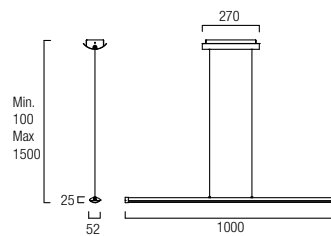

00-4424-21-M3

LED CREE 18W A++ A
1.500 lm 3000K

equivalente a
as bright as
5x20W G9 ECO Halogen

/102

Tulip

design Estudi Ribaudí





/103

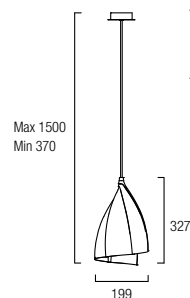

00-4416-05-23
00-4416-78-03

1 x E-27 Max. 23W /
Max. L=150mm Ø=60mm A++ c
Fluorescent - LED
Recommended
LED ACT-FLL-050



71-2232-14-14

05 **23** **78** **03**

ABS





Balloons

/105

design Josep Patsí

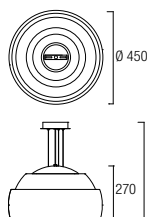

00-4348-21-F9
00-4348-BW-F9

1 x E-27 Max. 150W /
Max. L=195mm Ø=60mm
A++ C
Halogen - Fluorescent - LED



00-4348-BW-F9:

3 pantallas interiores intercambiables incluidas
3 interchangeable indoor screens included
3 abat-jour intérieurs et interchangeables inclus.
3 Innenschirme zum Auswechseln nicht im Lieferumfang enthalten
Include 3 parabolle interne intercambiabili
3 abat-jour interiores e intermutáveis incluídos
3 сменных абажура в комплекте
3 zamienne abazury wewnętrzne w komplecie

21 BW

ST TEX
TIL GLASS
OPAL 3
DIF



302





Twins

design **Benedito Design**

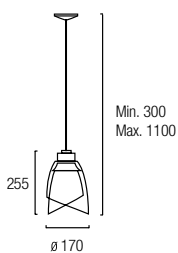

00-0087-N3-F9

1 x E-27 Max. 100W /
Max. L=150mm Ø=60mm A++ c
Halogen - Fluorescent - LED



71-2232-14-14

N3

ST GLASS TRANS DIF GLASS OPAL3 DIF







Blomma

design WIS Design





Blomma

/113

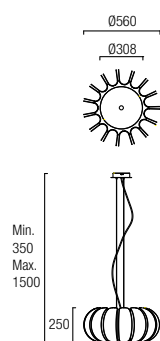

00-4391-BW-03
00-4391-BW-05
00-4391-BW-25

3 x E-27 Max. 23W / Max. L=140mm Ø=60mm A++ c
Fluorescent - LED

BW 03 05 25

ABS PMMA
DIF





Iris

design Gemma Bernal



21

ST PMMA PMMA
DIF SHADE

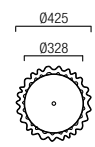
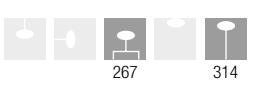
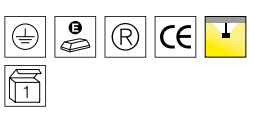

00-4413-21-M2
1 x 2GX13 55W A++ B

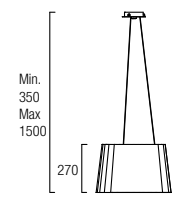

/116

Sky

design Nahtrang Disseny





/118



Confort visual
Visual comfort
Confort visuel
Sichtkomfort
Comfort visivo
Conforto visual
Визуальный комфорт
Komfort widzenia

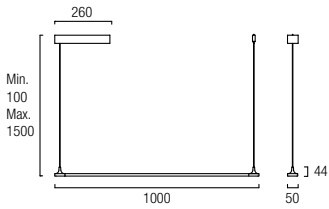

00-0049-AH-AH

(Dimmable 1-10V/PUSH/potentiometer 100Kohm)

LED CREE 18W A++ A
1.530 lm 3000K

**equivalente a
as bright as**
5x20W G9 ECO Halogen

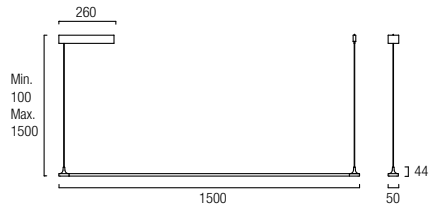

00-0052-AH-AH (Dimmable 1-10V)

LED CREE 27W A++ A
2.295 lm 3000K

**equivalente a
as bright as**
8x20W G9 ECO Halogen

AH

AL ABS



Sky

/119



/ 120

Emy

design Francesc Vilaró

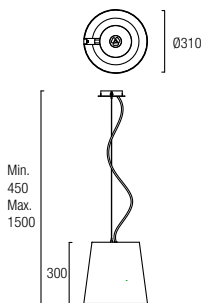

00-4409-21-12

1 x E-27 Max. 30W / Max. L=180mm Ø=60mm A++ c
Fluorescent - LED

21 12

AL PMMA PC
DIF SHADE





Siluet



design **Benedito Design**

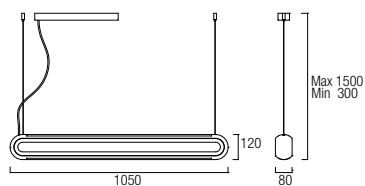
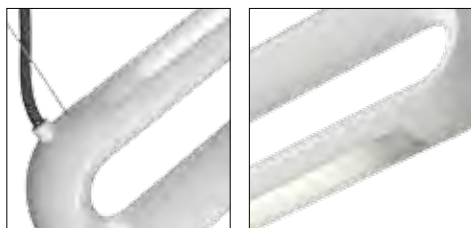

00-2801-14-M3

2 x T5 39W A++ B



Linear

/123

design **Benedito Design**

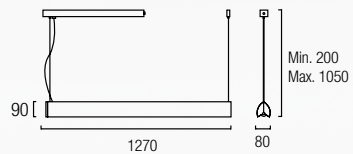
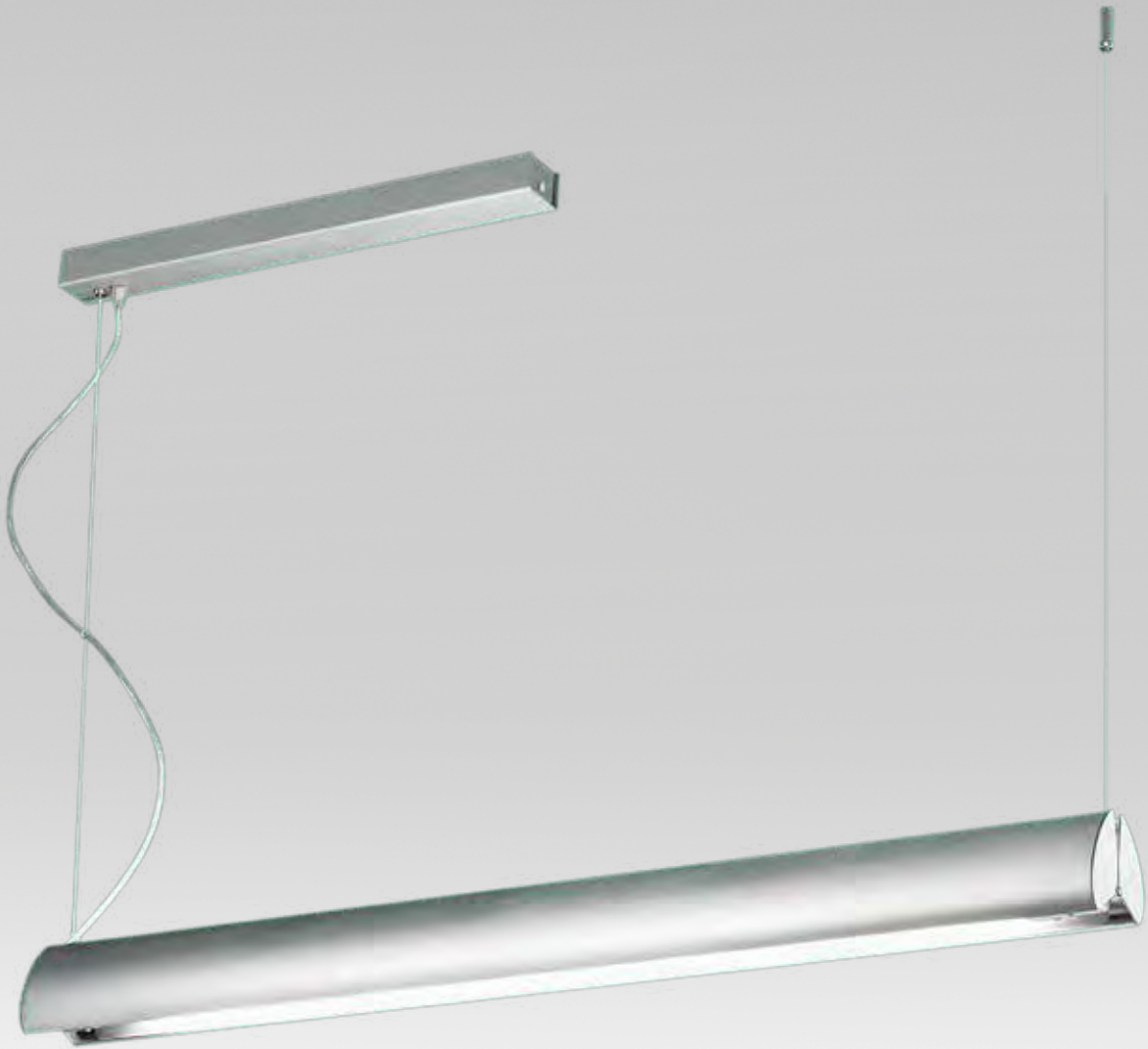

00-0338-Y6-Y6

1 x T5 54W A++ B
4000K included

Y6

AL



/124



Troppo

design **Benedito Design**

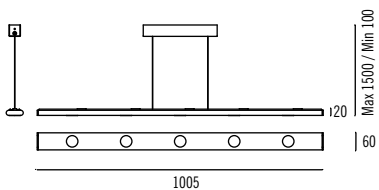

00-2804-21-F1

5 x G9 Max. 75W A++ C
OSRAM included

21

AL GLASS
BOSI
DIF



Slimm

design Estudi Ribaudí

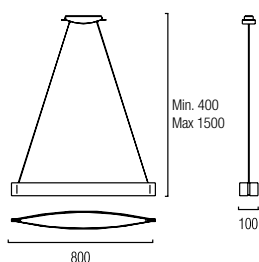

00-2397-Y5-E9

2 x R7s L=118 Max. 150W A++ c
OSRAM included



Incluye 3 acrílicos de color intercambiables
Includes 3 color interchangeable acrylic pieces
Comprend 3 pièces acryliques de couleur interchangeables
Mit 3 austauschbaren farbigen Acrylaufsätzen
Include 3 pezzi in acrilico di colori intercambiabili
Inclui 3 acrílicos de cores intermutáveis
3 сменных цветных акриловых вставки
Zawiera 3 akrylowe elementy o wymiennych kolorach

Y5

ST GLASS OPT DIF PMMA DIF



/ 126

Spin

design Nahtrang Disseny



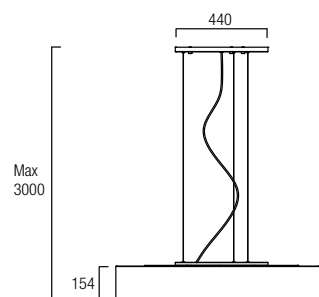
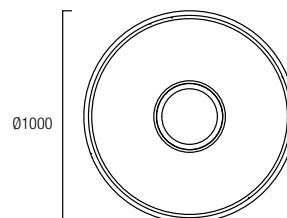
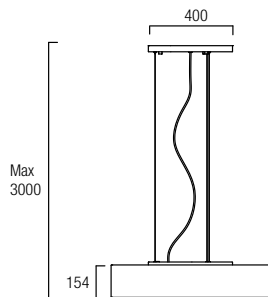
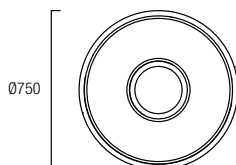
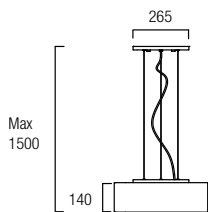
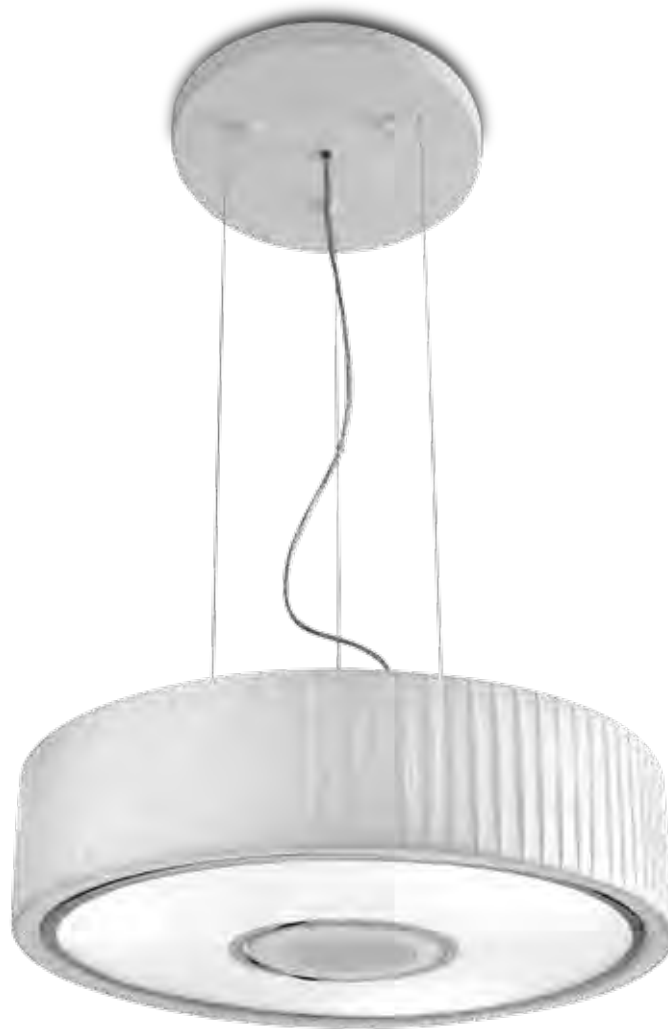

00-4601-21-05
00-4601-21-14

3 x E-27 Max. 23W / Max. L=190mm Ø=60mm
A++ C
Fluorescent - LED

00-4607-21-05
00-4607-21-14

5 x E-27 Max. 30W / Max. L=190mm Ø=60mm
A++ C
Fluorescent - LED

00-4615-21-05
00-4615-21-14

7 x E-27 Max. 30W / Max. L=190mm Ø=60mm
A++ C
Fluorescent - LED

21 05 14

ST TEXTIL PMMA DIF





Leila

design Benedito Design

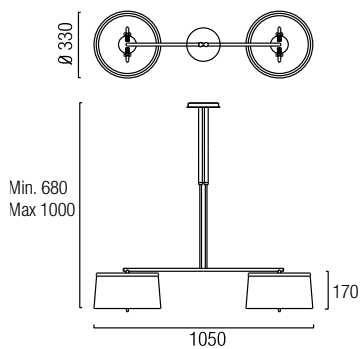

20-2407-AG-14

4 x E-14 Max. 15W / Max. L=145mm Ø=60mm
 Fluorescent - LED
 + 4 x G9 Max. 40W OSRAM included A++ c

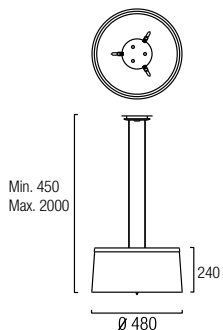
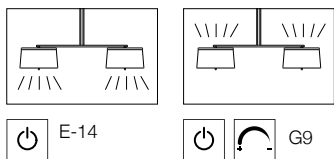

00-2407-AG-14

3 x E-27 Max. 23W / Max. L=180mm Ø=60mm
 Fluorescent - LED
Recommended LED ACT-FLL-050
 + 3 x G9 Max. 40W OSRAM included A++ c

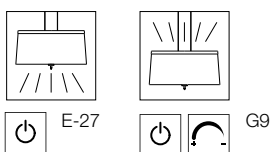

Wall fixtures

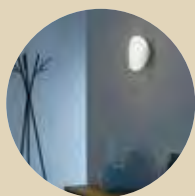
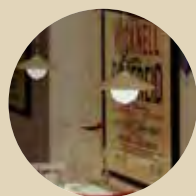
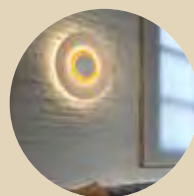
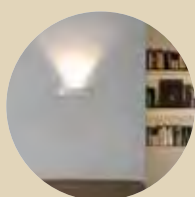
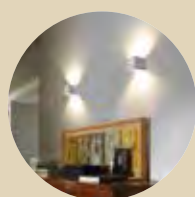
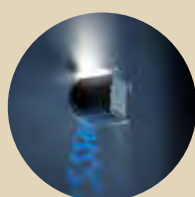
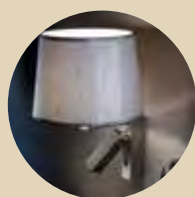
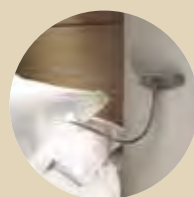
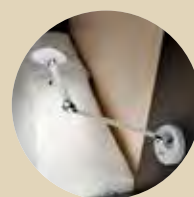
**Wave***p.132***Flap***p.136***Talk***p.138***Vintage***p.140***Bigbang***p.146***Invisible***p.150***Surf***p.154***Eos***p.158***Stream***p.160***Cell me***p.162***Rizz***p.166***Skata***p.170***Bend***p.172***Slimm***p.176***Ledbox***p.178***Flat***p.182***Lov***p.184***New Hotels***p.188***Emy***p.190***Suite***p.192***Hall***p.194***Supple***p.200***Open***p.202***Suite***p.204***Mirror***p.206*

Wave

new

design Josep Patsi





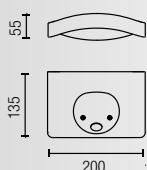

- 05-5488-AH-AH** 2700K
- 05-5488-BW-BW** 2700K
- 05-5499-BW-BW** 3000K

LED CREE 17,6W A++ A
2113 lm

<div style="display: flex; justify-content: space-around;"> <div style="border: 1px solid black; padding: 2px;">AH</div> <div style="border: 1px solid black; padding: 2px;">BW</div> </div>	<div style="display: flex; justify-content: space-around;"> <div style="border: 1px solid black; padding: 2px;">AL</div> <div style="border: 1px solid black; padding: 2px;">ST</div> <div style="border: 1px solid black; padding: 2px;">PMMA DIF</div> </div>	<div style="display: flex; justify-content: space-around; font-size: 0.8em;"> □ 220 240V RF 750 ® CE </div>	<div style="display: flex; justify-content: space-around;"> </div>
--	---	--	--



Flap ^{new}

design Benedito Design

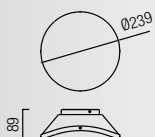

05-5276-BW-M1

LED 10W A++ A
1.000 lm 2700K

BW

ST PMMA
DIF



214



Talk^{new}

design Nahrang Disseny



05-5458-BW-F9
05-5458-Z5-F9

LED CREE 6,5W A++ A
695 lm 2700K

BW Z5

AL ST GLASS
DIF



/140



Vintage ^{new}

design Llusà & Santolaria





Vintage

/143



/144



Vintage

/145

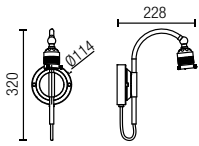

71-4819-CI-CIV1

LED Cree 8,3W A++ A
914 lm 3000K

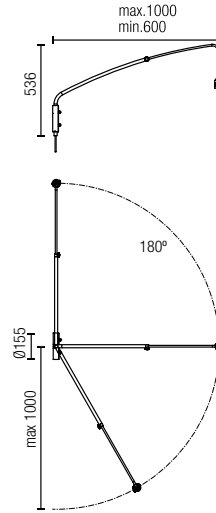

71-5490-CI-CI

LED Cree 8,3W A++ A
914 lm 3000K



71-5491-00-00

Not included

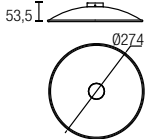

71-4821-CU-CU

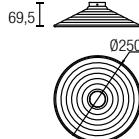

71-4824-20-20
71-4824-CI-CI

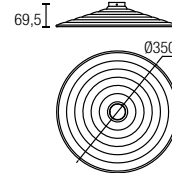

71-4940-CI-CI

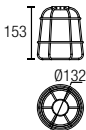

71-4825-CI-CI

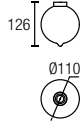

71-4817-F1-F1

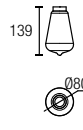

71-4818-F1-F1



Combinaciones / Combinations

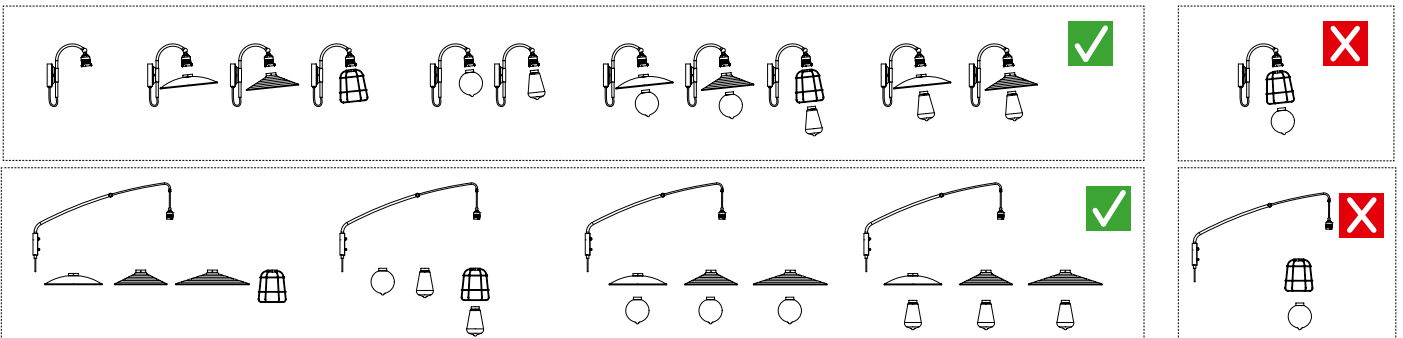

20 CI CU

ST AL GLASS DIF





Bigbang

design Francesc Vilaró



/148





Bigbang

/149

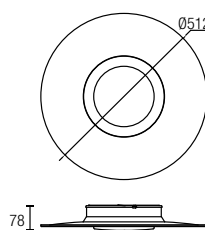

05-5085-BW-BW

LED 9W (Back)
765 lm 3000K
+
LED 13,5W (Front) A++ A
1.147 lm 3000K



Invisible

design Francesc Vilaró







Invisible

/153

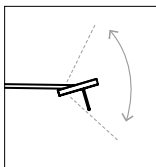
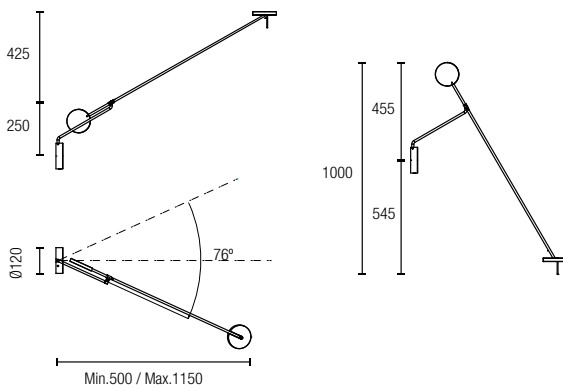
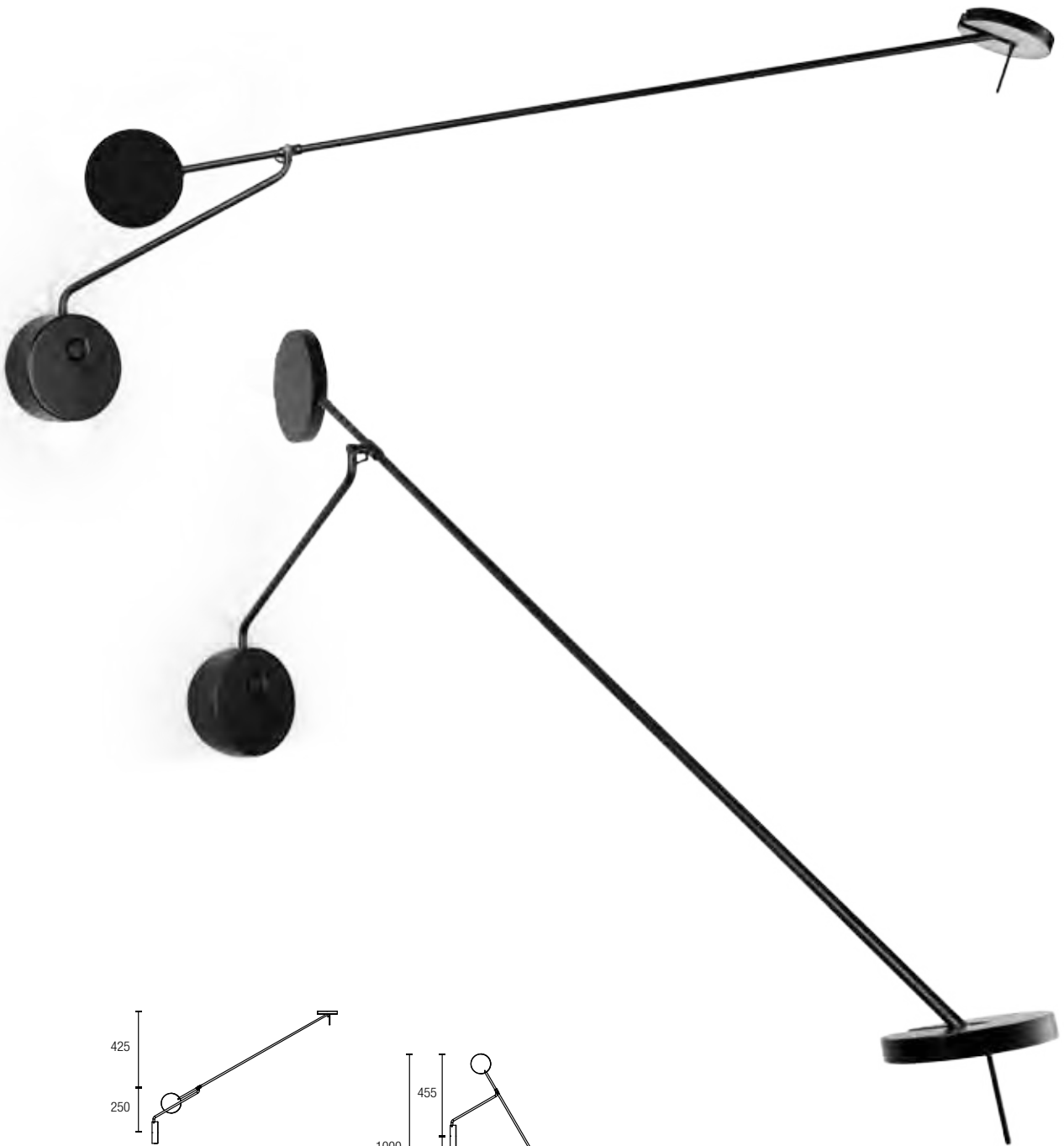

05-5079-05-05

LED 9W A++ A
765 lm 3000K



05

AL ST PMMA
DIF





Surf

design Josep Patsí



Incluye dos difusores intercambiables.
 It includes 2 interchangeable diffusers.
 Comprend deux diffuseurs interchangeables.
 Zwei austauschbare Diffusore im Lieferumfang enthalten.
 Include due diffusori intercambiabili.
 Inclui 2 difusores intercambiáveis.
 Включены два сменных рассеивателя.
 Zawiera dwa zamienne dyfuzory.

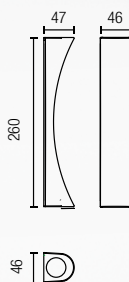

05-5077-BW-BW
 05-5077-21-21

2 LED x 4,5W A++ A
 580 lm 3000K

BW 21

AL PMMA
 DIF



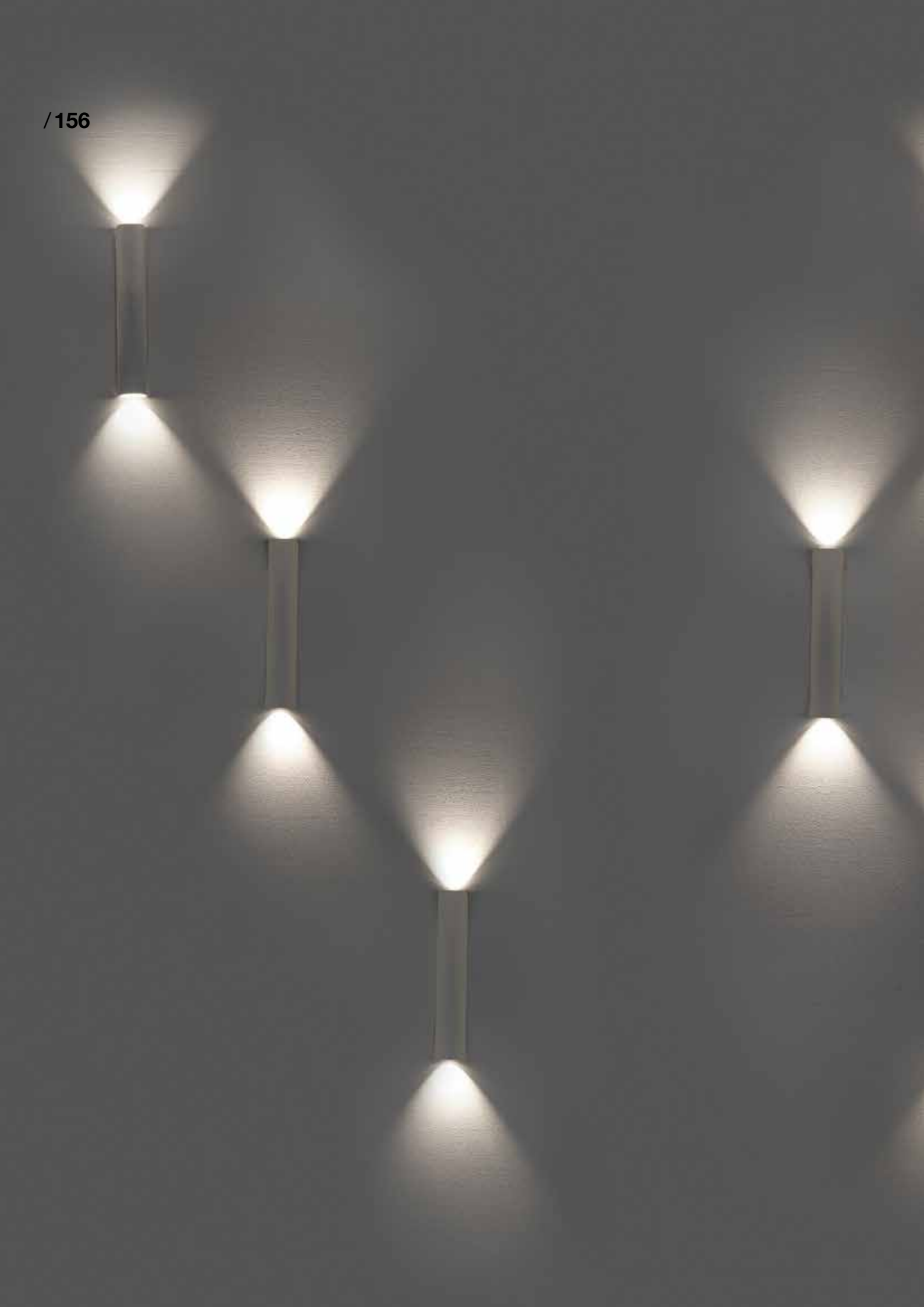

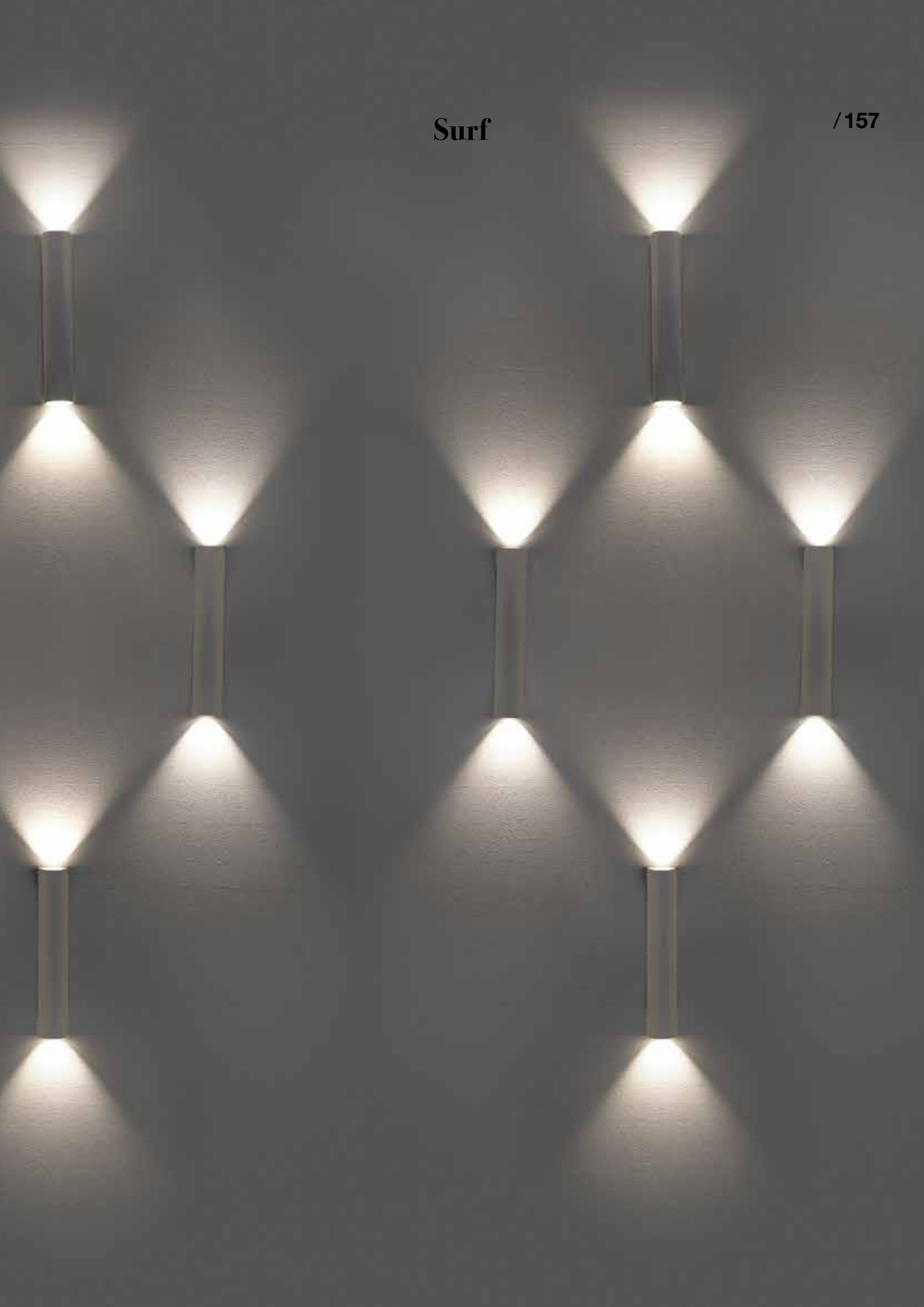

Eos

design Josep Patsí



Incluye dos difusores intercambiables.
 It includes 2 interchangeable diffusers.
 Comprend deux diffuseurs interchangeables.
 Zwei austauschbare Diffusore im Lieferumfang enthalten.
 Include due diffusori intercambiabili.
 Inclui 2 difusores intercambiáveis.
 Включены два сменных рассеивателя.
 Zawiera dwa zamiennie dyfuzory.

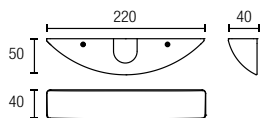

05-5078-BW-BW
 05-5078-21-21

LED x 4,5W A++ A
 290 lm 3000K

BW 21

AL PMMA
 DIF







Stream

design Josep Patsí

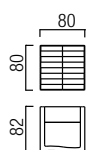

05-2924-BW-M3

LED CREE 4W A++ A
3000K 324 lm

BW

PUR AL PMMA
DIF



80

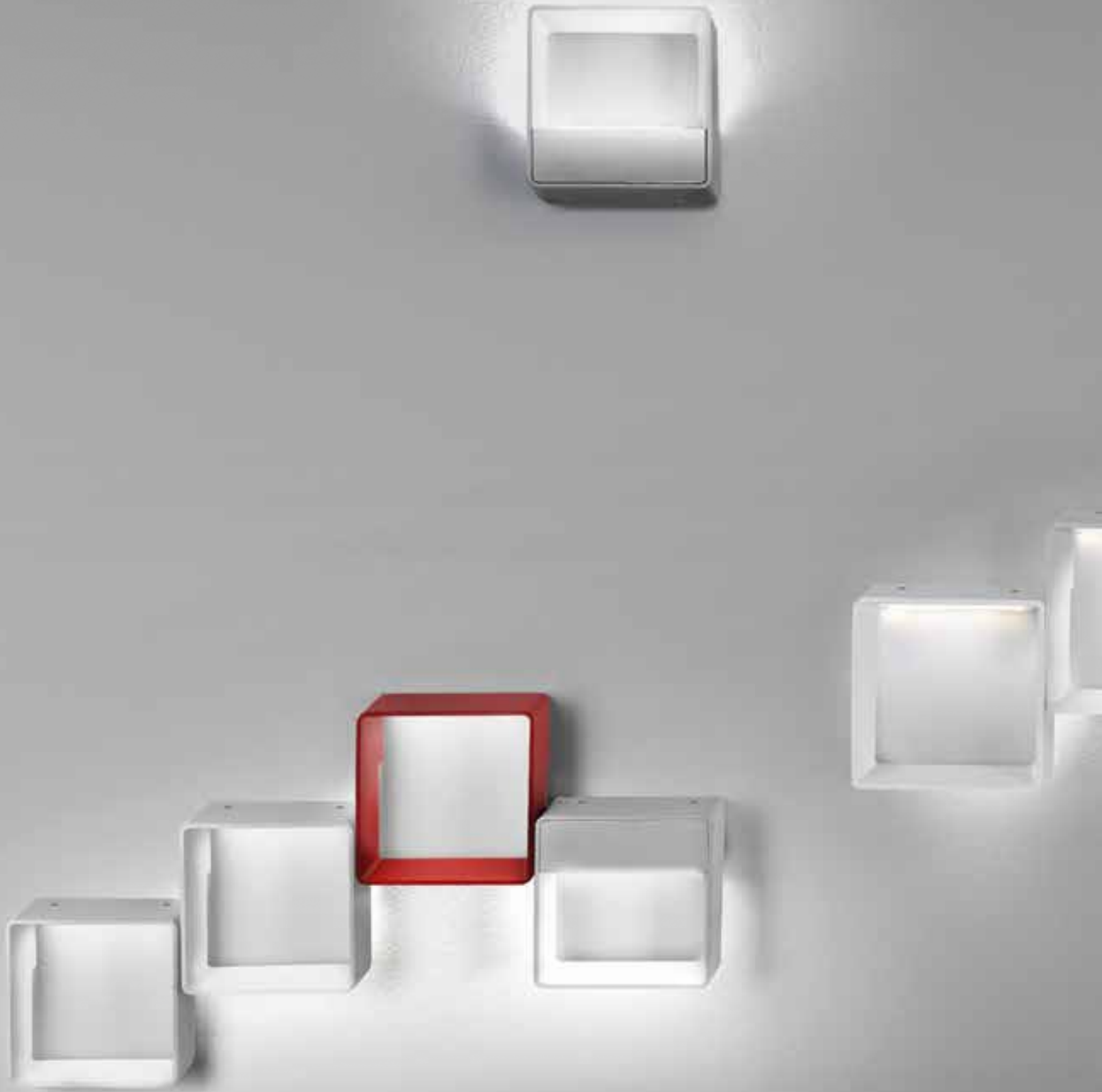

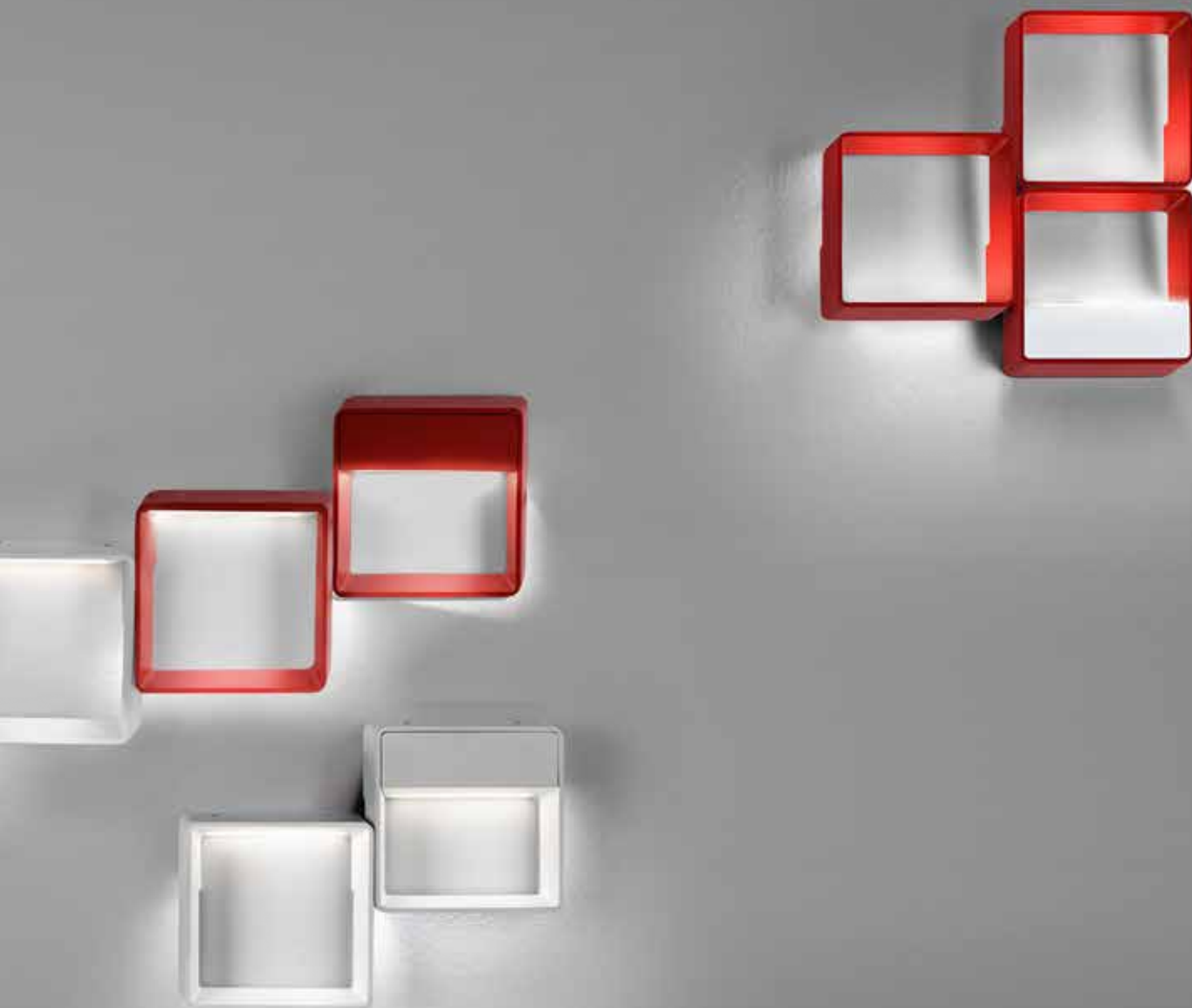

Cell me

design Francesc Vilaró



Basic Combination / Combinación básica



+



1 x 05-3544

Max. 3 x 71-3544

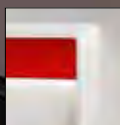
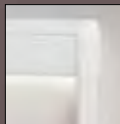

2 tapas frontales intercambiables incluidas.
It includes 2 interchangeable front covers.
2 caches frontaux interchangeables inclus.
inkl. 2 austauschbare vordere Abdeckungen.
Contiene 2 coperchi frontali intercambiabili.
Incluidas 2 tampas frontais inter-cambiáveis.
Включает 2 сменные лицевые панели.
Zawiera dwa wymienne fronty.

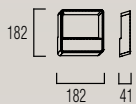

05-3544-BW-BW
05-3544-25-25

LED 3,4W A++ A
3000K 326 lm

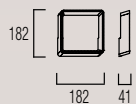

71-3544-BW-BW
71-3544-25-25

LED 3,4W
3000K 326 lm



Accesorio para realizar combinaciones.
Accessory for making combinations.
Accessoire pour la réalisation de combinaisons.
Accessorio per combinazioni.
Zubehör für Kombinationen.
Acessório para realizar combinações.
Аксессуар для создания комбинаций.
Akcesorium do wykonywania zestawień.

1
pieza / piece



05-3544 ✓



71-3544 ✗

2
piezas / pieces

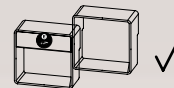

05-3544 + 71-3544 ✓

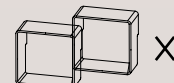

71-3544 + 71-3544 ✗

3/4
piezas / pieces

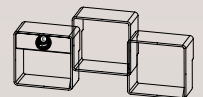

05-3544 + 2 x 71-3544 ✓



05-3544 + 2 x 05-3544 ✗

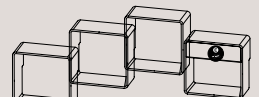

05-3544 + 3 x 71-3544 ✓





Rizz

design Ramón Valls

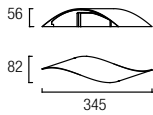
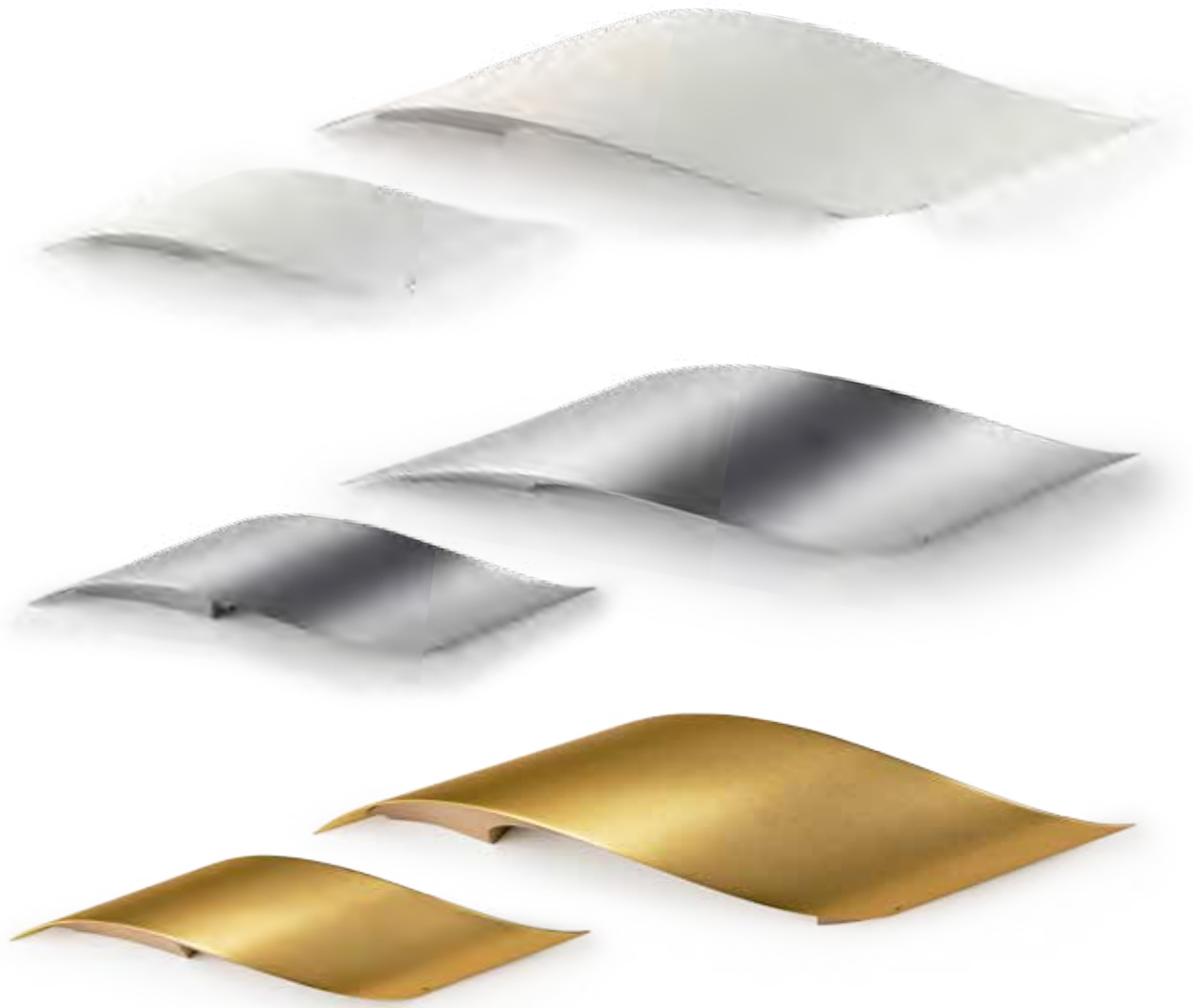

05-1819-AF-AF
05-1819-BW-BW
05-1819-27-27

LED CREE 6W A++ A
 3000K 510 lm

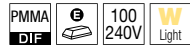

05-1817-AF-AF

1 x R7s L=78 Max. 80W A++ C
 OSRAM included

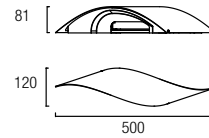

05-1822-AF-AF
05-1822-BW-BW
05-1822-27-27

LED CREE 10W A++ A
 3000K 850 lm

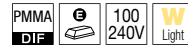

05-1818-AF-AF

1 x R7s L=118 Max. 120W A++ C
 OSRAM included



Su especial diseño permite múltiples combinaciones.
 Its special design allows for multiple combinations.

Esquema de conexión
 Connection scheme

27 AF BW

AL





/170

Skata

design Francesc Vilaró

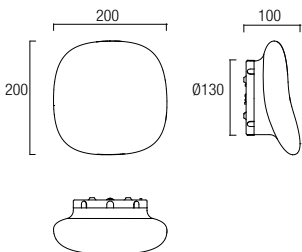

Su especial diseño permite múltiples combinaciones.
Its special design allows for multiple combinations.

Esquema de conexión
Connection scheme



05-4750-14-F9

LED 4,3W A++ A
413 lm 3000K

LED

14

ST GLASS
OPAL3
DIF





Bend

design Benedito Design





Bend

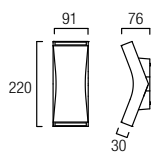

05-4394-78-M1V1
05-4394-AH-M1V1

2 LED CREE x 4,5W A++ A
 880 lm 3000K

78 AH

AL PMMA
 DIF







Slimm

design Estudi Ribaudí

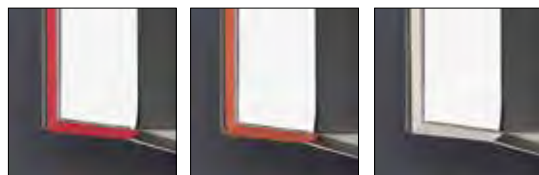
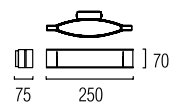

Incluye 3 acrílicos de color intercambiables
 Includes 3 color interchangeable acrylic pieces
 Comprend 3 pièces acryliques de couleur interchangeables
 Mit 3 austauschbaren farbigen Acrylaufsätzen
 Include 3 pezzi in acrilico di colori intercambiabili
 Inclui 3 acrílicos de cores intermutáveis
 3 сменных цветных акриловых вставки
 Zawiera 3 akrylowe elementy o wymiennych kolorach

05-2397-Y5-E9
05-2397-21-E9

1 x R7s L=118 Max. 150W A++ C
 OSRAM included

21 Y5

ST PMMA GLASS
 DIF OPT DIF



125



Ledbox

/179

design Josep Patsí

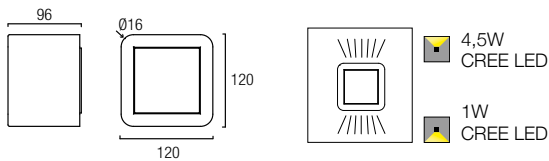

05-4716-03-M2

1 LED CREE x 1W 95 lm 3000K +
1 LED CREE x 4,5W A++ A 383 lm 3000K



Filtros incluidos / Filters included

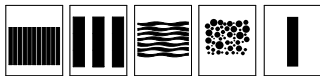

Filtros decorativos incluidos / Decorative filters included



Filtros señalización incluidos / Signal filters included



Productos personalizados bajo pedido
Customized products available upon request
Produits personnalisés sur commande
Sonderanfertigungen auf Anfrage
Prodotti personalizzabili su richiesta
Productos personalizados sob encomenda
Продукция, изготовленная на заказ
Zindywidualizowane produkty dostępne na zamówienie



03

AL PC



246





Productos personalizados bajo pedido
 Customized products available upon request
 Produits personnalisés sur commande
 Sonderanfertigungen auf Anfrage
 Prodotti personalizzabili su richiesta
 Produtos personalizados sob encomenda
 Продукция, изготовленная на заказ
 Indywidualizowane produkty dostępne na zamówienie

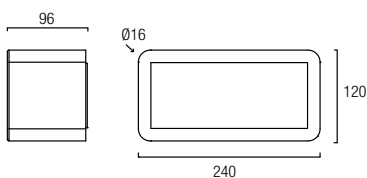

05-4717-03-M2

1 x G24q2 18W A++ B

03

AL PC PMMA
DIF



211



Flat

design Josep Patsí

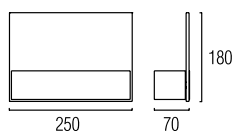

05-5093-81-B9
05-5093-BW-B9

LED CREE 8W A++ A
648 lm 3000K

LED

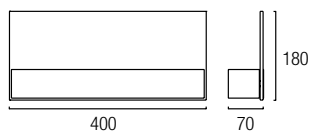

05-5092-81-B9
05-5092-BW-B9

LED CREE 16W A++ A
1.296 lm 3000K

LED



Productos personalizados bajo pedido
Customized products available upon request
Produits personnalisés sur commande
Sonderanfertigungen auf Anfrage
Prodotti personalizzabili su richiesta
Produtos personalizados sob encomenda
Продукция, изготовленная на заказ
Zindywidualizowane produkty dostępne na zamówienie

81 BW

ST ZAMAK GLASS OPT DIF



Lov

design Nahtrang Disseny

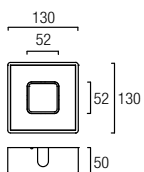

05-0047-BW-BW

2 LED x 4W A++ A
297 lm 3000K

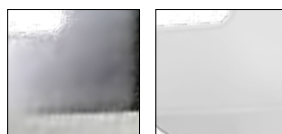

2 tapas frontales intercambiables incluidas.
It includes 2 interchangeable front covers.
2 caches frontaux interchangeables inclus.
inkl. 2 austauschbare vordere Abdeckungen.
Contiene 2 coperchi frontali intercambiabili.
Incluidas 2 tampas frontais inter-cambiáveis.
Включает 2 сменные лицевые панели.
Zawiera dwa wymienne fronty.

BW

AL PMMA
DIF





S
- POR
COMPARTIDA





TOUCH SWITCH

Sistema de doble iluminación independiente.
 Independent paired lighting system.
 Système à double éclairage indépendant.
 Unabhängiges doppeltes Beleuchtungssystem.
 Sistema a doppia illuminazione indipendente.
 Sistema de iluminação dupla independente.
 Система независимого двойного освещения.
 Niezależny łączony system oświetleniowy.



2 tapas frontales intercambiables incluidas.
 It includes 2 interchangeable front covers.
 2 caches frontaux interchangeables inclus.
 inkl. 2 austauschbare vordere Abdeckungen.
 Contiene 2 coperchi frontali intercambiabili.
 Incluídas 2 tampas frontais inter-cambiáveis.
 Включает 2 сменные лицевые панели.
 Zawiera dwa wymienne fronty.

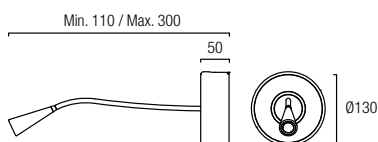

05-0658-BW-BW

2 LED x 4W A++ A 297 lm +
 1 LED CREE x 3W 195 lm 3000K



New Hotels

design Benedito Design

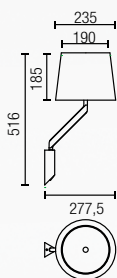

05-3686-21-T005

1 x E-27 Max. 18W / Max. L=125mm Ø=78mm A++ c
Fluorescent - LED

--	--	--	--

Emy

design Francesc Vilaró

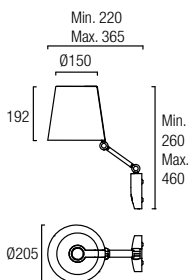

05-4409-21-12

1 x E-14 Max. 15W / Max. L=100mm Ø=45mm A++ c
Fluorescent - LED

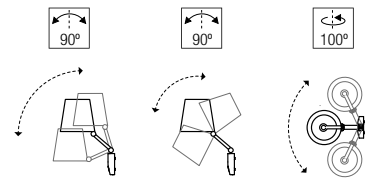

21 12

AL PC PMMA
SHADE DIF



120

266

316



Suite

design Benedito Design



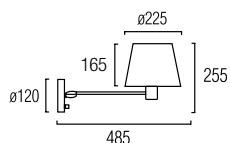

05-0381-81-AJ

1 x E-27 Max. 60W / Max. L=140mm Ø=60mm A++ c
Halogen - Fluorescent

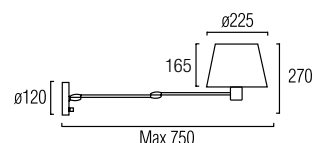

05-0382-81-AJ

1 x E-27 Max. 60W / Max. L=140mm Ø=60mm A++ c
Halogen - Fluorescent

Hall collection Dress up

Viste la estructura a tu gusto.
Dress the structure with the shade of your choice.
Habillez la structure à votre goût.
Stellen Sie die Struktur nach Ihrem Geschmack ein.
Struttura il tuo stile.
Veste a estrutura a teu gosto.
Выбери абажур и создай свою лампу.
Sam dobierz abażur do wybranej lampy.

1-Step

Elige la estructura en el acabado que más te guste.

Choose the structure in the finish that best suits you.

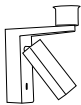

2-Step

Elige la forma, tamaño y acabado de la pantalla. Verás nuestras recomendaciones en las páginas siguientes.

Select the shape, size and finish of the shade. You can see our recommendations on the following pages.

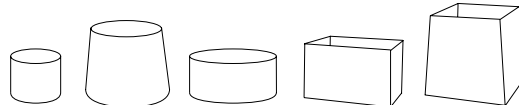

3-Step

¡Tu lámpara está lista!
Your lamp is now ready!

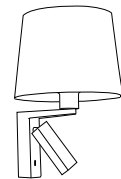

Pantallas redondas / Round shades

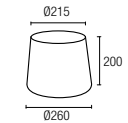
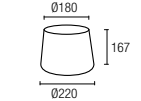
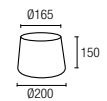
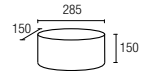

14	PAN-175-14	PAN-177-14	PAN-157-14	PAN-161-14
BY	PAN-175-BY	PAN-177-BY	PAN-157-BY	PAN-161-BY
AJ	PAN-194-AJ			

Pantallas cuadradas / Squared shades

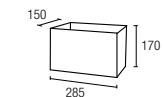
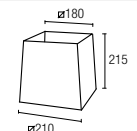
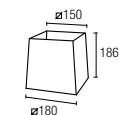

14	PAN 178-14	PAN-179-14	PAN-180-14	PAN-176-14
BY	PAN 178-BY	PAN-179-BY	PAN-180-BY	PAN-176-BY

LEDs-C4 te ofrece la posibilidad de personalizar totalmente las pantallas, eligiendo la forma, el tamaño, el material y el acabado más idóneo para cada ambiente.

LEDs-C4 offers you the possibility to entirely customize the shades, choosing the shape, size, material and the most appropriate design for each atmosphere.







05-1941-BW-82 + PAN-179-14

05-1941-81-82 + PAN-194-AJ

05-1941-BW-82 + PAN-157-14

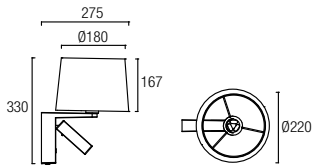

05-1941-BW-82 + PAN
05-1941-81-82 + PAN

1 x E-27 Max. 60W / Max. L=130mm Ø=60mm
Halogen - Fluorescent - LED
1 x LED CREE 3W A++ C
162 lm 3000K



Combinaciones / Combinations

	285	165	180	215	150	150
	150	150	167	200	186	170
	150	200	220	260	180	285
14	PAN-177-14	PAN-157-14		PAN-161-14	PAN-179-14	PAN-176-14
BY	PAN-177-BY	PAN-157-BY		PAN-161-BY	PAN-179-BY	PAN-176-BY
AJ	PAN-194-AJ					

Hall

design Nahrang Disseny

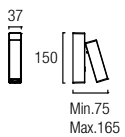

05-1940-BW-BW
05-1940-81-81

LED CREE 3W A++ A
162 lm 3000K



/197

81 BW

AL ZAMAK

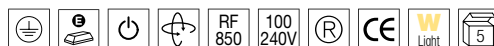

258

290

Hall

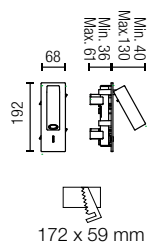

05-4787-BW-BW
05-4787-81-81

LED CREE 3W A++ A
162 lm 3000K

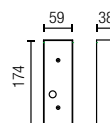

71-4787-AV-AV

ST
GALV

Kit para empotrar en pared de obra
Recessing kit for brick wall
Kit pour encastrer au mur
Kit zum Einbauen im Mauerwerk
Kit per incasso a parete
Kit para encastrar em parede de obra
Набор для встроенного монтажа
Zestaw do montażu w ścianach z cegły

81 BW

AL ZAMAK

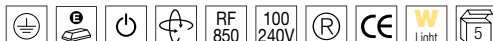



/ 200



Supple

design Josep Patsí

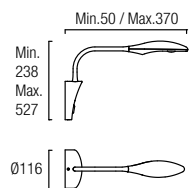

05-4415-78-M2

1 LED CREE x 4,5W A++ A
383 lm 3000K

78	AL ST SIL PC DIF		
----	---------------------	--	--





Suite

design **Benedito Design**

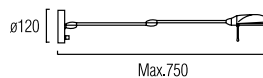

05-0380-81-B8
05-0380-BW-B8

1 x G9 Max. 75W A++ C
OSRAM included

81 BW

ST GLASS MAT DIP

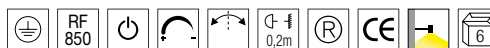



Mirror

design Josep Patsí

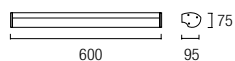

05-0265-Y6-M1

1 x T5 24W A++ B
4000K included

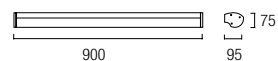

05-0266-Y6-M1

1 x T5 39W A++ B
4000K included

Y6

AL PC
DIF

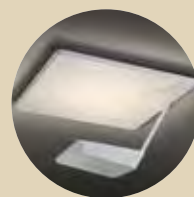

Ceiling fixtures

**Rigatto***p.210***Flap***p.214***Circ***p.216***Single***p.218***Six***p.220***Ace***p.224***Net***p.226***Ibis***p.230***Ona***p.232***Tandem***p.234***Traç***p.236***Ocho***p.238***Troppo***p.240***Escher***p.241***Spin***p.242***Nemo***p.244***Ledbox***p.246*





Rigatto^{new}

design Gemma Bernal



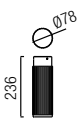

15-5278-21-21 2700K
15-5278-BW-BW 2700K
15-5494-BW-BW 3000K

LED CREE 7,2W A++ A
 775 lm

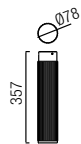

15-5279-21-21 2700K
15-5279-BW-BW 2700K
15-5495-BW-BW 3000K

LED CREE 7,2W A++ A
 775 lm

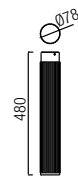

15-5280-21-21 2700K
15-5280-BW-BW 2700K
15-5496-BW-BW 3000K

LED CREE 7,2W A++ A
 775 lm

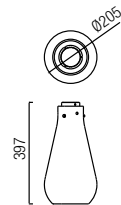

15-5281-21-37 2700K
15-5281-BW-37 2700K
15-5497-BW-37 3000K

LED CREE 7,2W A++ A
 775 lm

GLASS
 DIF

21 BW

AL ST PMMA
 DIF





Flap ^{new}

design **Benedito Design**

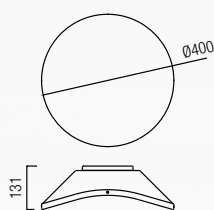

15-5277-BW-M1

LED OSRAM 32W A++ A
3.200 lm 2700K



			136
--	--	--	-----



Circ

design Grok team



15-4875-BW-M3 
15-4871-BW-M3 (Mains dimming)* 

LED 26W A++ A
 2.496 lm 3000K

equivalente a
as bright as
 **9x20W G9 ECO Halogen**

BW

AL ST PMMA
 DIF







Single

/219

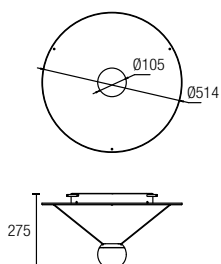
design Josep Patsí



15-5099-BW-BW 
15-5099-D9-D9
15-5100-BW-BW (Mains dimming)* 
15-5100-D9-D9 (Mains dimming)*

LED 25W A++ A
3.011 lm 2700K

 **equivalente a
as bright as**
1x300W R7s Halogen



ST



/ 220



Six

design Josep Patsí





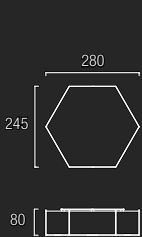
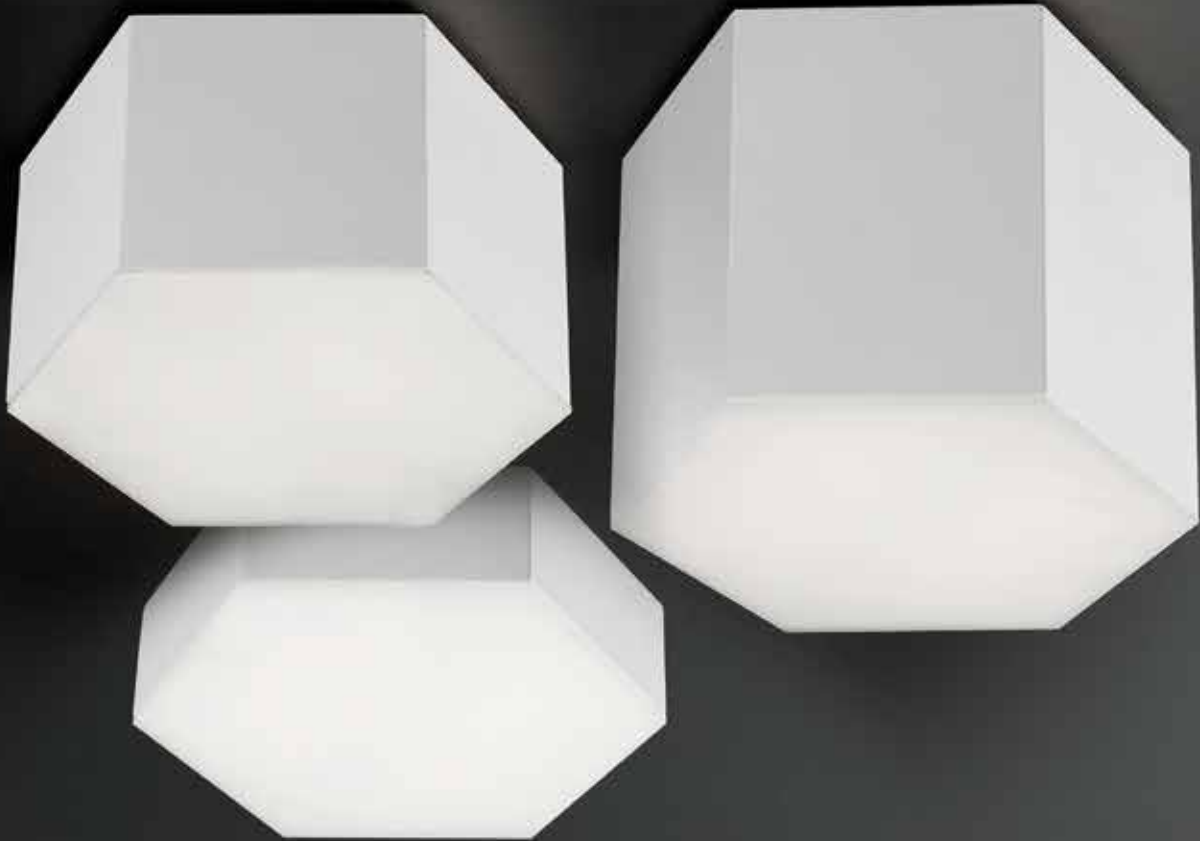

15-1950-BW-M1

LED 15W
1440 lm 3000K

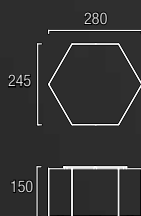

15-1956-BW-M1

LED 15W A++ A
1440 lm 3000K



15-1959-BW-M1

LED 15W A++ A
1440 lm 3000K



Equivalente a
60W Bright as
14x20W G9 ECO Halogen

Su especial diseño permite múltiples combinaciones.
Its special design allows for multiple combinations.

Esquema de conexión
Connection scheme



Para versiones regulables, por favor consulte con equipo comercial
For dimmable versions, please get in contact with your sales representative.





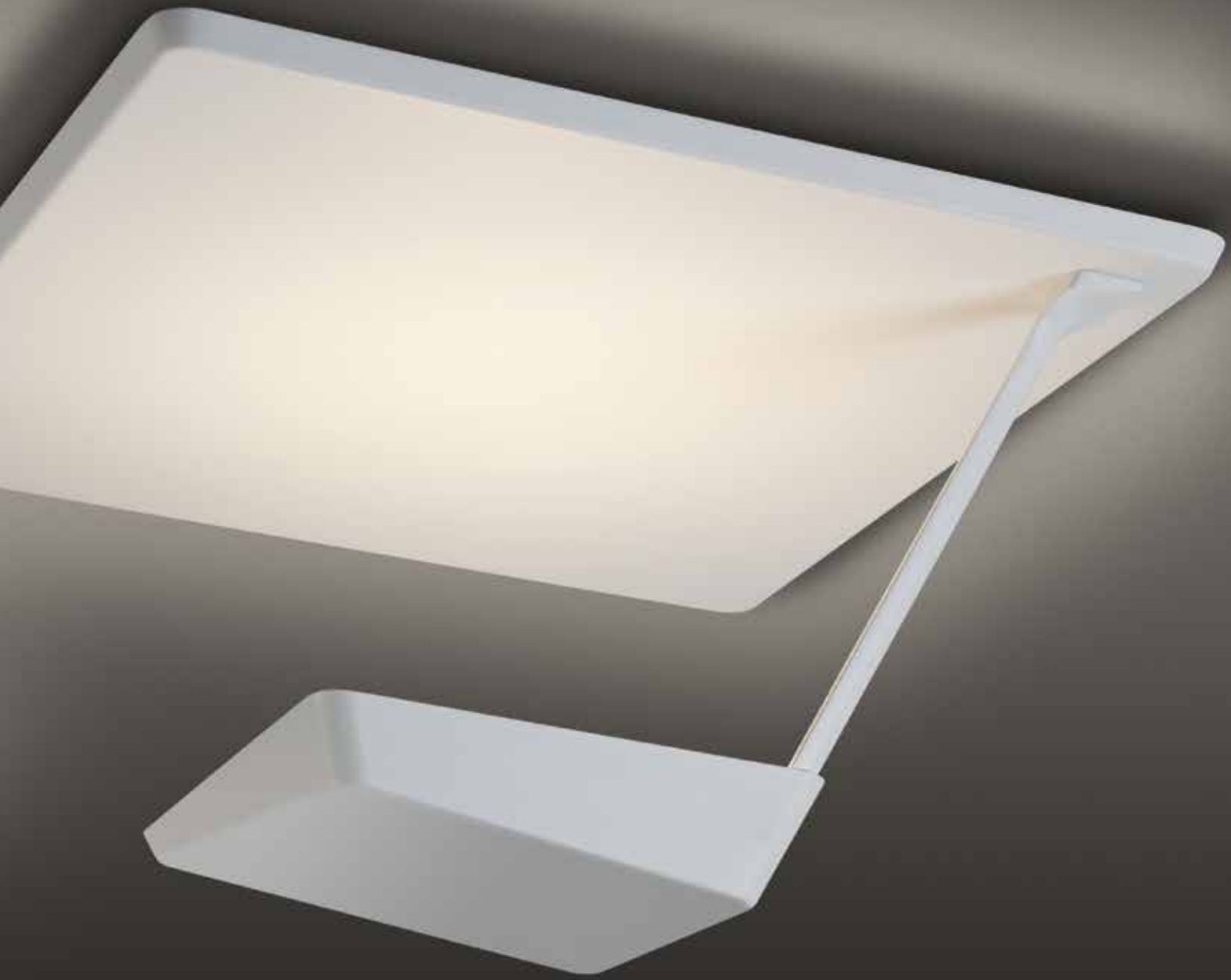

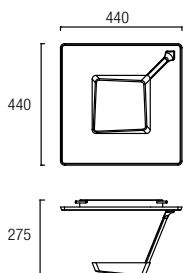
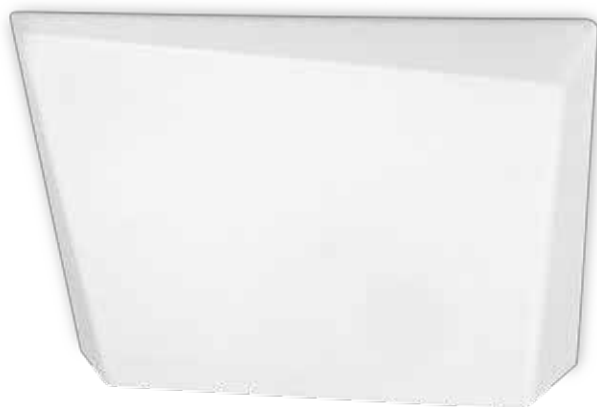

Ace

design Josep Patsí



15-2412-BW-BWV1 
15-4784-BW-BW (Mains dimming)* 

12 x LED CREE 26W A++ A
 1944 lm 3000K



**equivalente a
 as bright as**
 1x200W R7s Halogen

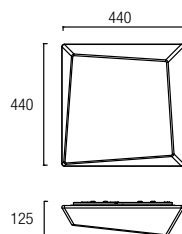

15-2411-BW-M1

1 x 2GX13 40W + 1 x 2GX13 22W A++ B

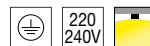

BW

ST PMMA
 DJF



* Compatibilidad con reguladores corte de fase en www.leds-c4.com / Productos & Descargas) / Mains dimmer compatibility at www.leds-c4.com (Products & Downloads) / Compatible avec des variateurs en coupe de phase que vous pouvez consulter www.leds-c4.com (Produits & Téléchargements) / Kompatibilität mit Phasenanschnittregler bei www.leds-c4.com (Produkte & Downloads) / Per verificare la compatibilità con regolatori di tagli di fase consultare www.leds-c4.com (Prodotti & Downloads) / Compatibilidade com reguladores por corte de fase em www.leds-c4.com (Produtos e Downloads) / Возможность использования с регуляторами по отсечке фазы на www.leds-c4.com (Продукция и Скачивание) / Kompatybilność ze ściemniaczami sieciowymi na www.leds-c4.com (Produkty & Do Pobrania)



Net

/227

design Josep Patsí

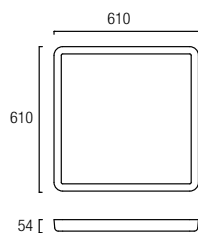

15-0003-BW-M1 (Standard)
15-0835-BW-M1 (Dimmable 1-10V)

LED 55W A++ A
5.280 lm 3000K

PUR

equivalente a
as bright as
3x60W E-27 Halogen

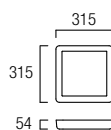

15-3536-BW-M1 (Standard)

LED 30W A++ A
2.880 lm 3000K

PUR

equivalente a
as bright as
3x60W E-27 Halogen



71-2241-00-00

Controlador con mando a distancia para
Versiones Standard
Controller with remote control for
Standard Version



INCLUDED

BW CH

PS
DIP



86

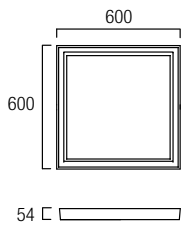

15-3538-CH-MI (Standard)
15-3825-CH-MI (Dimmable 1-10V)

LED 55W A++ A
 5.280 lm 3000K



equivalente a
 as bright as
 6x60W E-27 Halogen

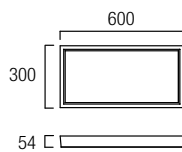

15-3537-CH-MI (Standard)

LED 45W A++ A
 4.320 lm 3000K



equivalente a
 as bright as
 5x60W E-27 Halogen

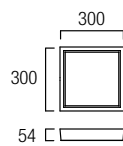

15-3535-CH-MI (Standard)

LED 30W A++ A
 2.880 lm 3000K



equivalente a
 as bright as
 3x60W E-27 Halogen



71-2241-00-00

Controlador con mando a distancia
 para **Versiones Standard**
 Controller with remote control for
Standard Version





/ 230



Ibis

design Grok Team

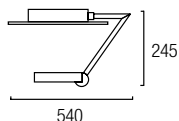

IBIS C/47-81
IBIS C/47-BW

1 x R7s L=118 Max. 300W A++ C
OSRAM included

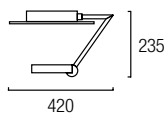
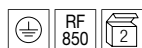

IBIS C/37-81
IBIS C/37-BW

1 x R7s L=118 Max. 200W A++ C
OSRAM included

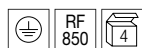

15-3231-BW-BWV1

15-3231-81-81V1

15-4785-81-81 (Mains dimming)*

15-4785-BW-BW (Mains dimming)*

LED CREE 26W A++ A
1944 lm 3000K



equivalente a
as bright as
1x200W R7s Halogen

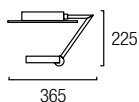

IBIS C/27-81

1 x R7s L=78 Max. 150W A++ C
OSRAM included

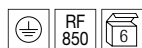

81 BW

ST



Ona

design Josep Patsí



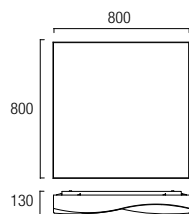

15-5096-S2-M1 (Standard)
15-5120-S2-M1 (Mains dimming)*

LED 62W A++ A
 5270 lm 3000K



**equivalente a
 as bright as**
 6x60W E-27 Halogen

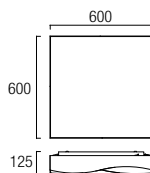

15-5095-S2-M1 (Standard)
15-5119-S2-M1 (Mains dimming)*

LED 40W A++ A
 3400 lm 3000K



**equivalente a
 as bright as**
 4x60W E-27 Halogen

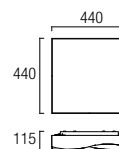

15-5094-S2-M1 (Standard)
15-5118-S2-M1 (Mains dimming)*

LED 20W A++ A
 1700 lm 3000K



**equivalente a
 as bright as**
 2x60W E-27 Halogen

S2

AL PMMA
 DIF



* Compatibilidad con reguladores corte de fase en www.leds-c4.com (Productos & Descargas) / Mains dimmer compatibility at www.leds-c4.com (Products & Downloads) / Compatible avec des variateurs en coupure de phase que vous pouvez consulter www.leds-c4.com (Produits & Téléchargements) / Kompatibilität mit Phasenanschnittregler bei www.leds-c4.com (Produkte & Downloads) / Per verificare la compatibilità con regolatori di taglio di fase consultare www.leds-c4.com (Prodotti & Downloads) / Compatibilidade com reguladores por corte de fase em www.leds-c4.com (Produtos e Downloads) / Возможность использования с регуляторов по отсечке фазы на www.leds-c4.com (Продукция и Скачивание) / Kompatybilność ze ściemniaczami sieciowymi na www.leds-c4.com (Produkty & Do Pobrania)

Tandem

/235

design Benedito Design

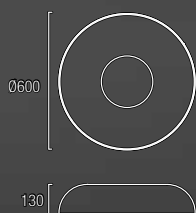

15-0056-BW-M1

1 x 2GX13 40W + 1 x 2GX13 22W A++ B



15-0778-BW-M1

1 x 2GX13 55W A++ B

BW

ST PMMA
DIF



90

Traç

design Josep Patsí

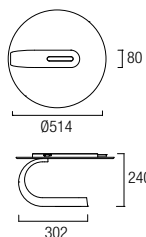

15-2870-AH-F1
15-2870-D9-F1
15-2870-D8-F1

1 x R7s L=118 Max. 300W A++ c
OSRAM included





Ocho

design Josep Patsí



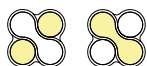

Sistema de doble iluminación independiente
 Independent double lighting system
 Système double éclairage indépendant
 Unabhängiges doppeltes Beleuchtungssystem
 Sistema di doppia illuminazione indipendente
 Sistema de dupla iluminação independente
 Система независимого двойного освещения
 Niezależny system podwójnego oświetlenia

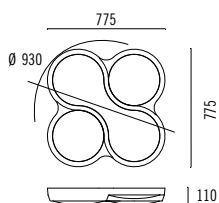

15-2807-14-M1

4 x 2GX13 55W A++ B

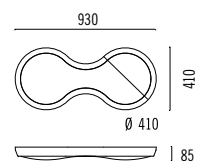

15-2806-14-M1

2 x 2GX13 55W A++ B

14

PUR PMMA
 DIF



Troppo

design Benedito Design

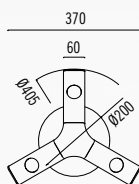
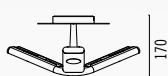
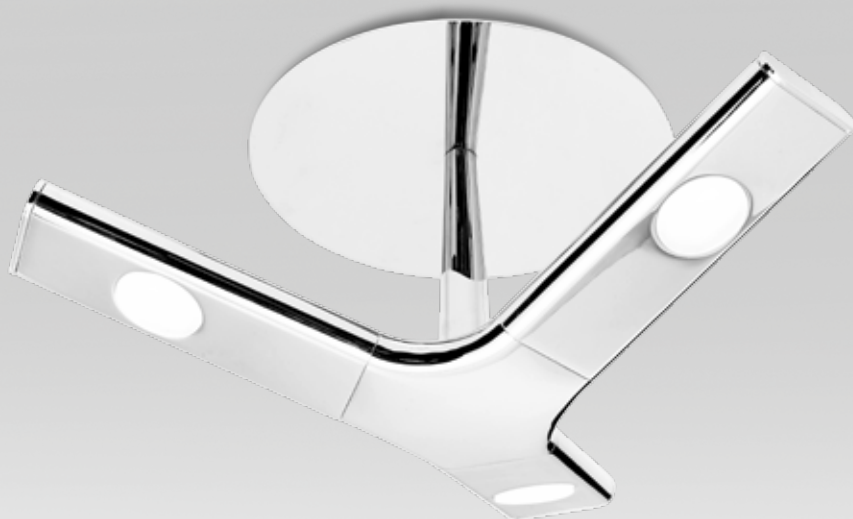

15-2804-21-F1

3 x G9 Max. 75W A++ C
OSRAM included

Escher

design Josep Patsí

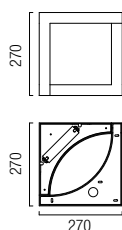
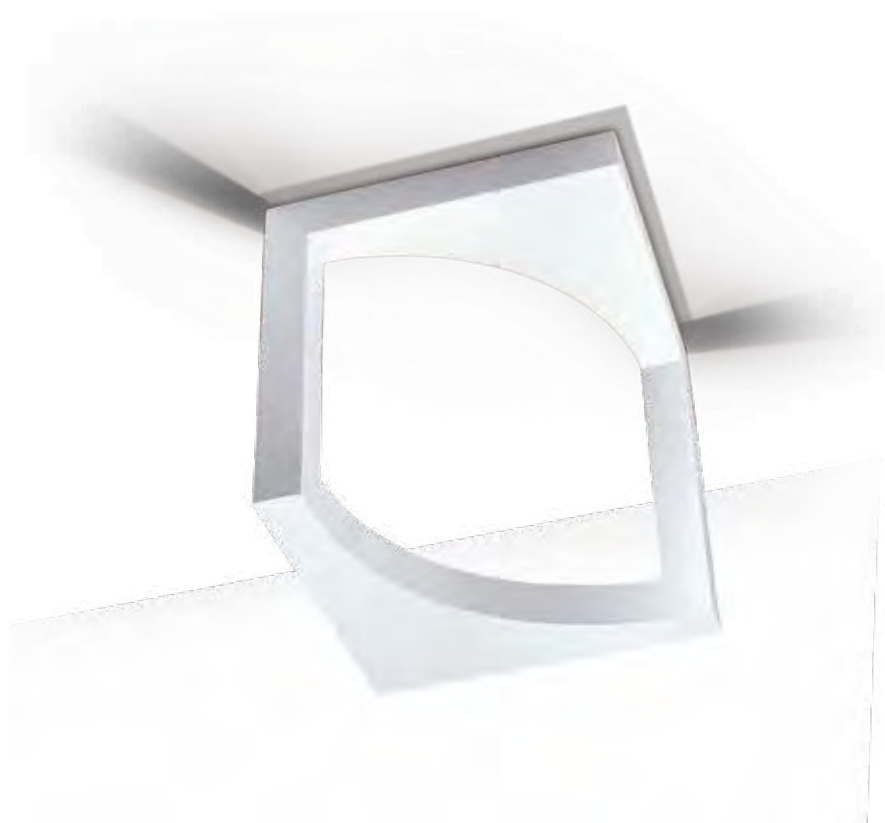

15-2782-AH-AH
15-2782-78-78

1 x R7s L=118 Max. 300W A++ c
OSRAM included

AH 78

ST





Spin

design Nahtrang Disseny

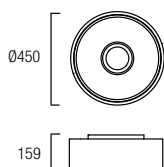

15-4601-21-05
15-4601-21-14

3 x E-27 Max. 23W / Max. L=190mm Ø=60mm
A++ C
Fluorescent - LED

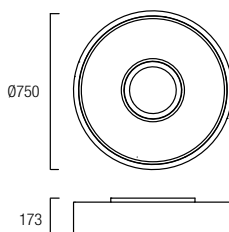

15-4607-21-05
15-4607-21-14

5 x E-27 Max. 30W / Max. L=190mm Ø=60mm
A++ C
Fluorescent - LED

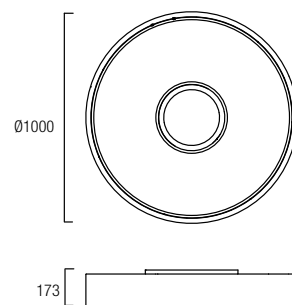

15-4615-21-05
15-4615-21-14

7 x E-27 Max. 30W / Max. L=190mm Ø=60mm
A++ C
Fluorescent - LED

Nemo

design Benedito Design



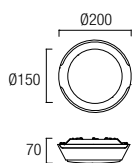

15-4332-21-F9

1 x R7s L=78 Max. 100W A++ c
OSRAM included

/246



Ledbox

design Josep Patsí



03

AL PC



178

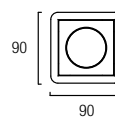

15-4716-03-M2

1 x GU10 Max. 35W / L=56mm Ø=50mm

A++ C

Halogen - LED

Recommended

LED ACT-FLL-024 5W 24°

LED ACT-FLL-025 5W 35°

Table lamps

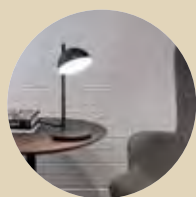

Talk

p.250

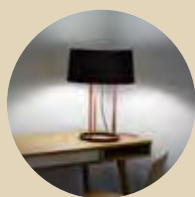

Premium

p.252



New Hotels

p.256



Hall

p.258

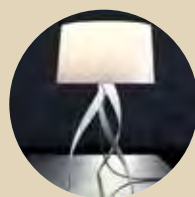

Medusa

p.260



Blomma

p.264



Emy

p.266

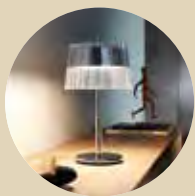

Iris

267



Sway

p.268

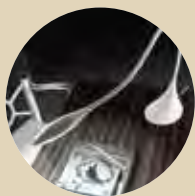

Supple

p.270



Open

p.272

250

Talk

new

design Nahtrang Disseny



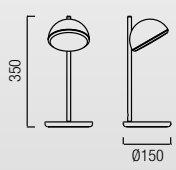

10-5458-BW-F9
10-5458-Z5-F9

LED SAMSUNG 4,5W A++ A
 290 lm 2700K

--	--	--	--

/ 252

Premium

design Jordi Llopis





/254





Top diffuser

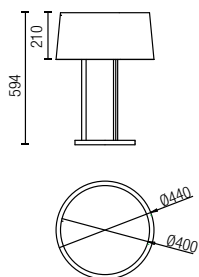

10-5076-06-H13W

3 x E-27 Max. 18W / Max. L=140mm Ø=52mm A++ c
Fluorescent - LED

06 H13W

ST TEXTIL SHADE PMMA DIF



New Hotels

design Benedito Design

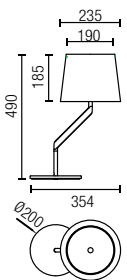
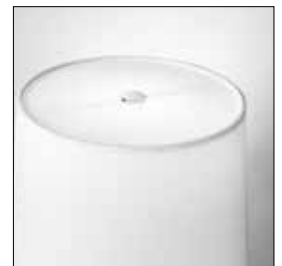

10-3686-21-T005

1 x E-27 Max. 18W / Max. L=125mm Ø=78mm A++ c
Fluorescent - LED

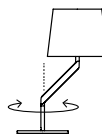

21 T005

ZAMAK ST TEXTIL SHADE PMMA DIF





Hall

design Nahtrang Disseny





Top diffuser

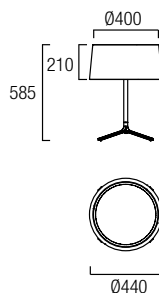

10-1940-05-H13W
10-1940-BW-T007

3 x E-27 Max. 18W / Max.L=140mm. Ø52mm A++ C
 Fluorescent-LED

BW **T007**
 SHADE

05 **H13W**
 SHADE

ST **TEXTIL** **PMMA**
 SHADE **DIF**



194

290

/260

Medusa

design Ramón Valls





/ 262



Medusa

/263



Top diffuser

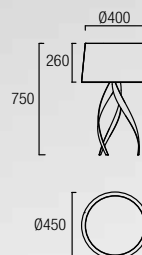

10-1824-BW-T002
10-1824-BW-T003

1 x E-27 Max. 18W / Max. L=140mm A++ C
Fluorescent - LED

BW T002 T003

AL TEXTIL PVC PMMA
SHADE SHADE DIF
T002 T003



292

Blomma

design WIS Design



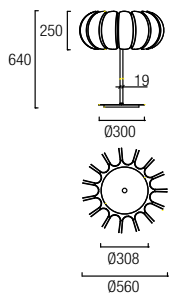

10-4391-BW-03
 10-4391-BW-05
 10-4391-BW-25

3 x E-27 Max. 23W / Max. L=140mm Ø=60mm A++ c
 Fluorescent - LED

BW 03 05 25

ST ABS PMMA
 DIF



Emy

design Fransesc Vilaró

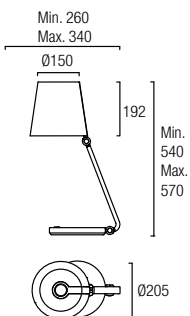

10-4409-21-12

1 x E-14 Max. 15W / Max. L=100mm Ø=45mm A++ c
Fluorescent - LED

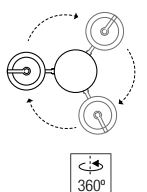
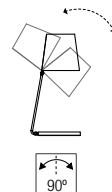
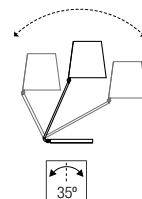

21 12

AL PC PMMA
SHADE SHIELD DIF



Iris

/267

design Gemma Bernal

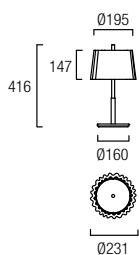

10-4413-21-M2

2 x E-14 Max. 15W / Max. L=100mm Ø=45mm A++ c
Halogen - Fluorescent - LED

21

ST PMMA
SHADE



114

314



Sway

design Josep Patsí

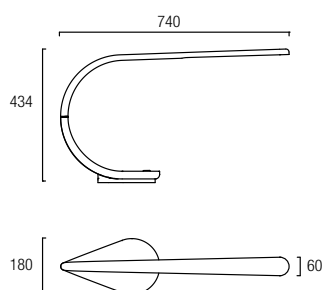

10-0055-BW-BW

LED CREE 9W A++ A
486 lm 3000K

BW

PUR PMMA
DIP



/270

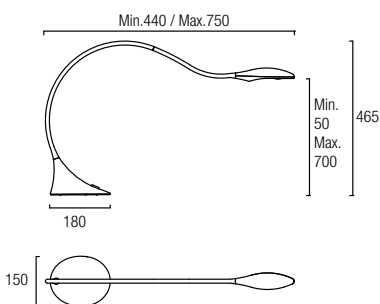

10-4415-05-M2
10-4415-78-M2

LED CREE x 4,5W A++ A
383 lm 3000K



05	78	AL	ST	SIL	PC	DTF					100 240V							200	320
----	----	----	----	-----	----	-----	--	--	--	--	-------------	--	--	--	--	--	--	-----	-----

Supple

/271

design Josep Patsí



/272

Open

design Josep Patsí

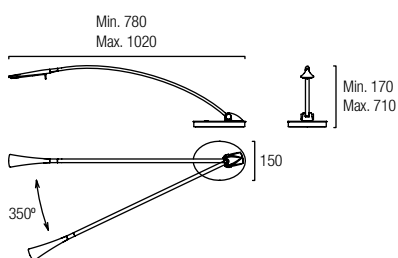

10-2708-21-21

LED CREE x 4,5W A++ A
383 lm 3000K

Floor lamps

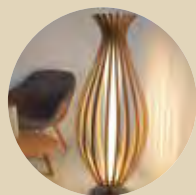
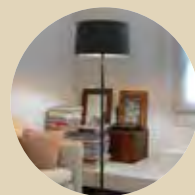
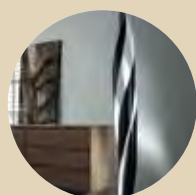
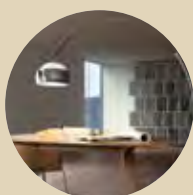
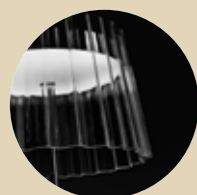
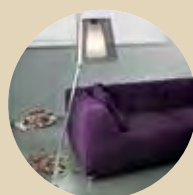
**Bamboo***p.276***Premium***p.278***Total***p.282***New Hotels***p.286***Hall***p.290***Medusa***p.292***Bosquet***p.296***Circ***p.300***Hoop balloons***p.302***Hoop***p.306***Ace***p.308***Bold***p.310***Blomma***p.312***Iris***p.314***Emy***p.316***Leila**

318

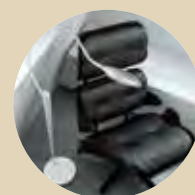
**Supple***p.320***Totem**

322

/276

Bamboo

design Gemma Bernal

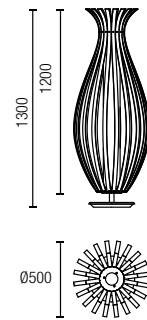

25-4035-CT-93

LED 22W A++ A
1870 lm 3000K



Bambú
Bamboo
Bambou
Bambus
Bamboo
Bambu
Бамбук
Bambus

CT

ST WOOD PMMA
DIP



48





Premium

design Jordi Llopis

/280



Premium

/281

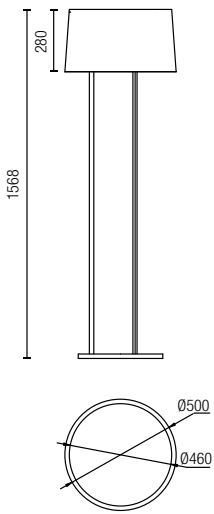
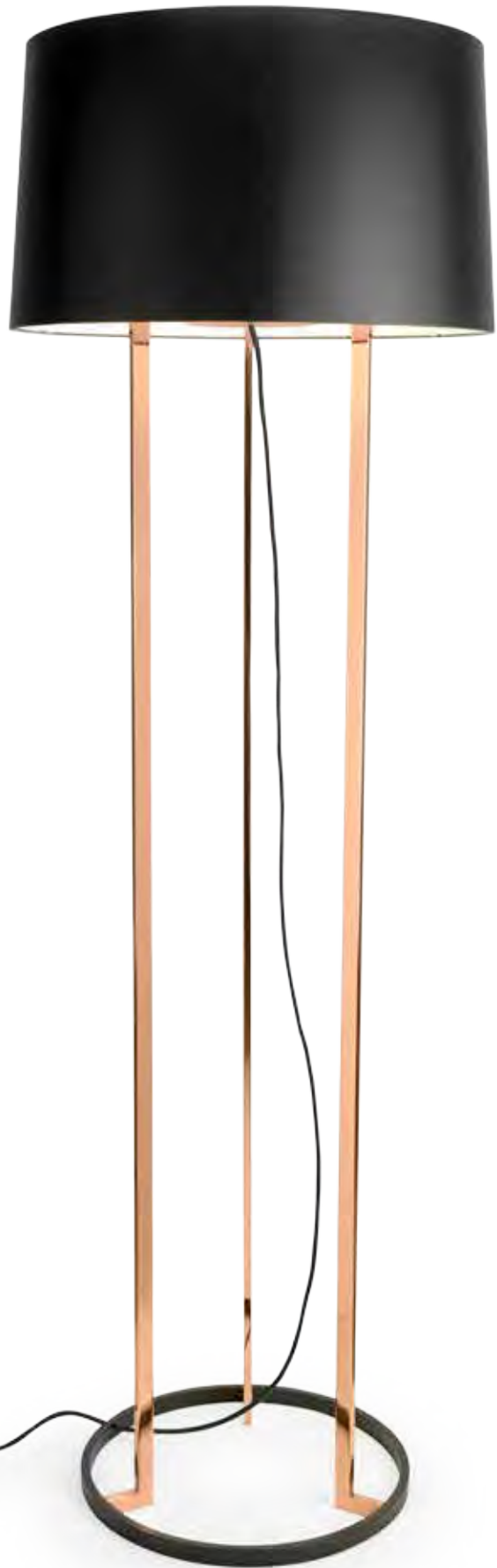

25-5076-06-H13W

3 x E-27 Max. 30W / Max. L=176mm Ø=60mm A++ C
Fluorescent - LED

Top diffuser



06 H13W

ST TEXTIL SHADE



/282

Total

design Josep Patsí





Total



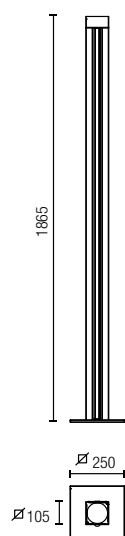

25-4786-AF-M1
25-4786-CT-M1

LED CREE 18W
 (UP) 2.440 lm 3000K
 +
 LED 12W A++ A
 1.015 lm 3000K

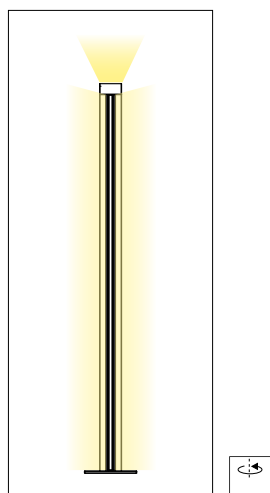

Sistema de doble iluminación independiente.
 Independent paired lighting system.
 Système à double éclairage indépendant.
 Unabhängiges doppeltes Beleuchtungssystem.
 Sistema a doppia illuminazione indipendente.
 Sistema de iluminação dupla independente.
 Система независимого двойного освещения.
 Niezależny łączony system oświetleniowy.



AF CT

AL PMMA
 DIF





New Hotels

design Benedito Design

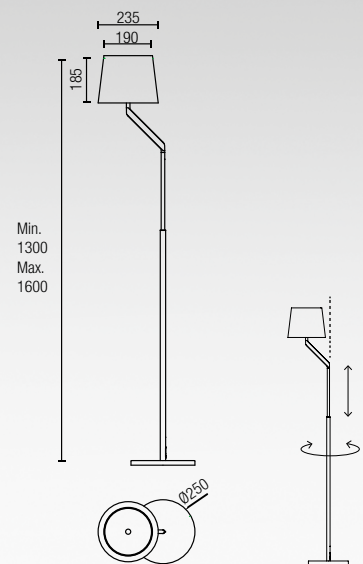

25-3686-21-T005

1 x E-27 Max. 18W /
 Max. L=125mm Ø=78mm A++ c
 Fluorescent - LED

New Hotels

/289



/290

Hall

design Nahtrang Disseny

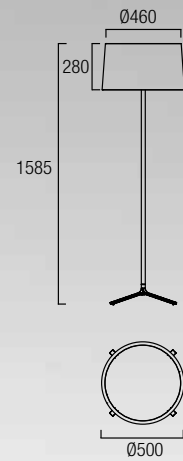

25-1940-05-H13W
25-1940-BW-T007

3 x E-27 Max. 30W / Max.L=176mm. Ø60mm
A++ C
Fluorescent-LED

Top diffuser



BW T007 SHADE 05 H13W SHADE

ST TEXTIL SHADE PMMA DJF



194 258



Medusa

design Ramón Valls







Medusa

/295

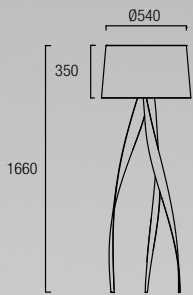

25-1823-BW-T002
25-1823-BW-T003

1 x E-27 Max. 30W /
Max. L=195mm Ø=60mm
A++ C
Fluorescent - LED

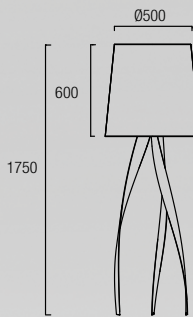

25-1824-BW-T002
25-1824-BW-T003

1 x E-27 Max. 30W /
Max. L=195mm Ø=60mm
A++ C
Fluorescent - LED

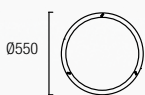

71-1759-BW-BW



Bosquet

design Ramón Valls

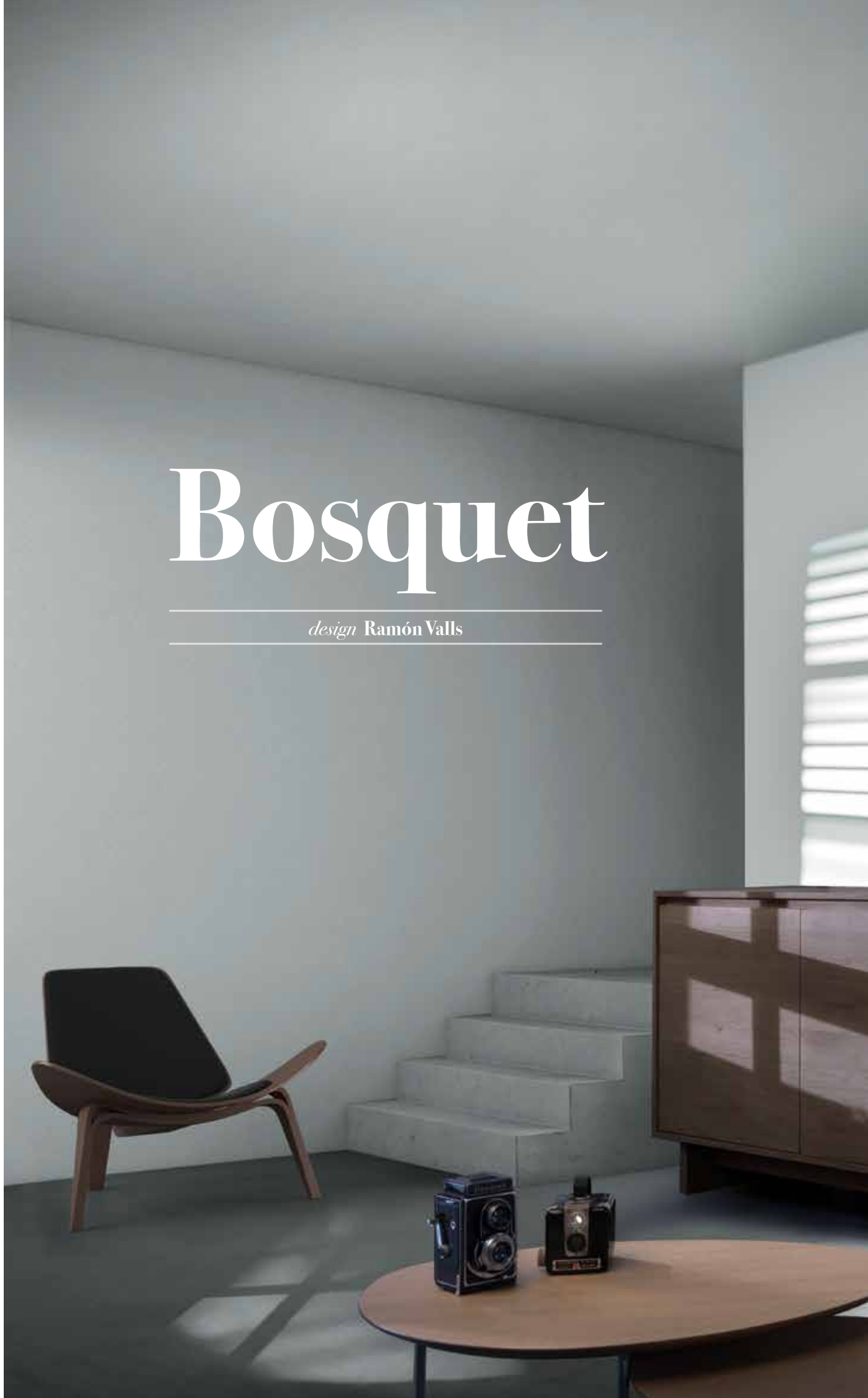





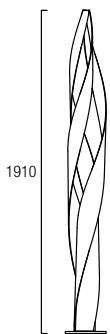

25-1837-05-05

1 x E-27 Max.150W /
Max. L=195mm Ø= 60mm A++ c
Halogen - Fluorescent - LED
Recommended E-27 PAR 30
Max.75W

05

AL

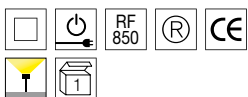

/300

Circ

design Grok Team

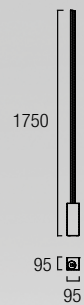

25-2934-BW-M3

LED 27W A++ A
2.592 lm 3000K



71-2934-BW-BW

Accesorio para zonas transitadas
Accessory for transit areas
Accessoire pour zones de passage
Zubehör für begehbare Bereiche
Accessorio per zone ad alto transito
Acessório para zonas de passagem.
Аксессуар для использования в зонах
общественного пользования
Akcesoria do stref pieszych

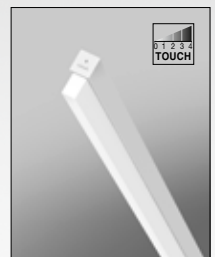

BW

AL PMMA
DIF





Hoop balloons

design Josep Patsí





Hoop balloons



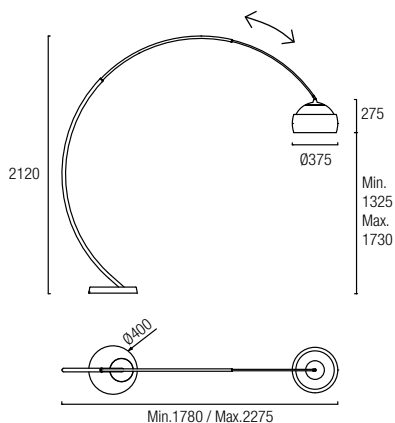
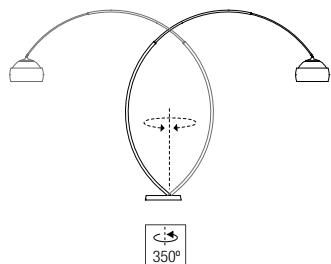

25-0058-BW-M1

1 x E-27 Max. 23W / Max. L=160mm Ø=60mm
 A++ C
 Fluorescent - LED



/306

Hoop

design Josep Patsí

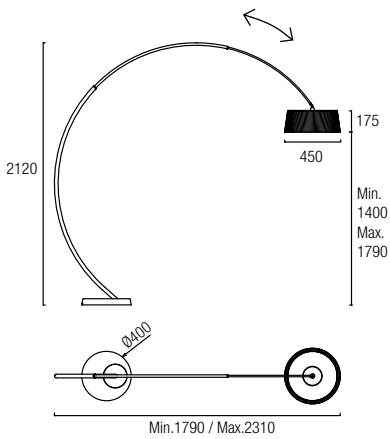

25-0057-BW-M1

3 x E-27 Max. 23W / Max. L=140mm Ø=60mm
A++ C
Fluorescent - LED

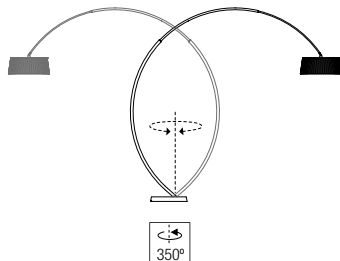
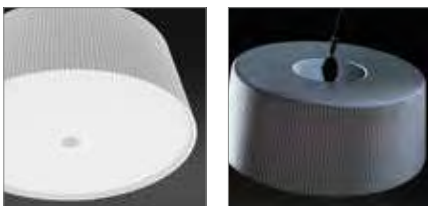

BW

ST PMMA PUR
DIF SHADE





/308

Ace

design Josep Patsí

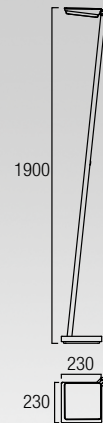

25-2410-BW-M3

LED CREE 28W A++ A
1.944 lm 3000K

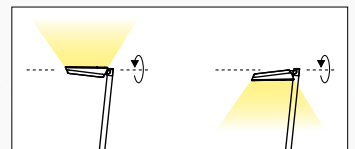
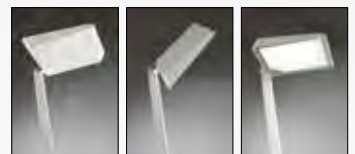

			224
--	--	--	-----



/310

Bold

design Estudi Ribaudí

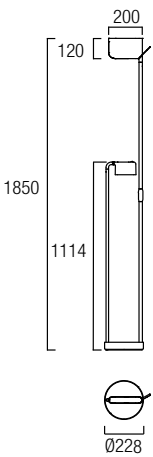
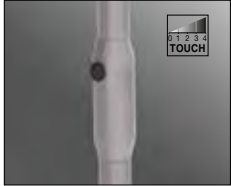

25-3230-CH-M3

LED CREE 19,8W A++ A

1.458 lm 3000K

LED CREE 6,6W A++ A

486 lm 3000K



CH

AL

PMMA
DIP



100
240V



CE

W
Light





/312

Blomma

design WIS Design



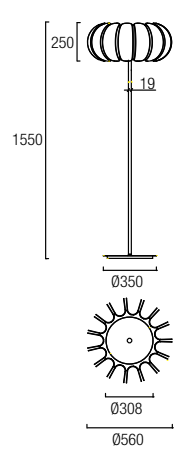

25-4391-BW-03
25-4391-BW-05
25-4391-BW-25

3 x E-27 Max. 23W / Max. L=140mm Ø=60mm
A++ C
Fluorescent - LED

BW 03 05 25

ST ABS PMMA DIF



/314

Iris

design Gemma Bernal

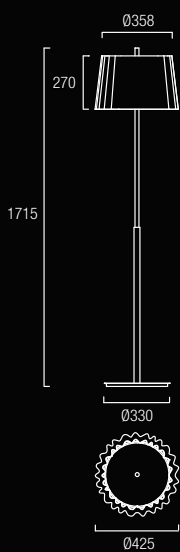

25-4413-21-M2

1 x 2GX13 55W A++ B



21				
ST	PMMA DIF	PMMA SHADE		
⊕	⏻	Ⓢ	®	CE
☂	📦			
114	267			

/316



Emy

/317

design Fransesc Vilaró

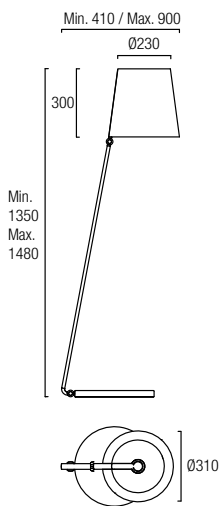

25-4409-21-12

1 x E-27 Max. 30W / Max. L=180mm Ø=60mm
A++ C
Fluorescent - LED

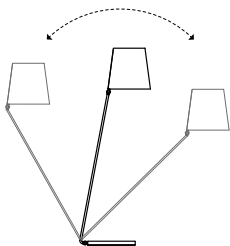

35°



90°

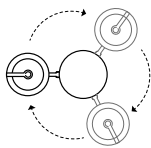

360°

21 12

AL PC PMMA
SHADE DIF



120 190 266

/318

Leila

design Benedito Design

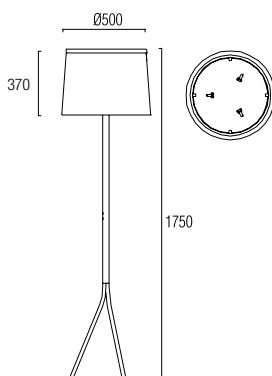

25-2407-AG-14

3 x E-27 Max. 23W / Max. L=140mm Ø=60mm
Fluorescent - LED
+ 3 x G9 Max. 40W A++ c OSRAM included

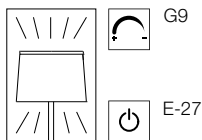

AG 14

AL ST TEXTIL SHADE





/ 320

Supple

design Josep Patsí



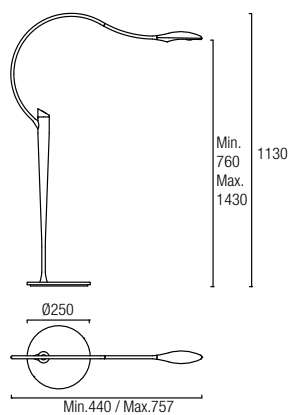
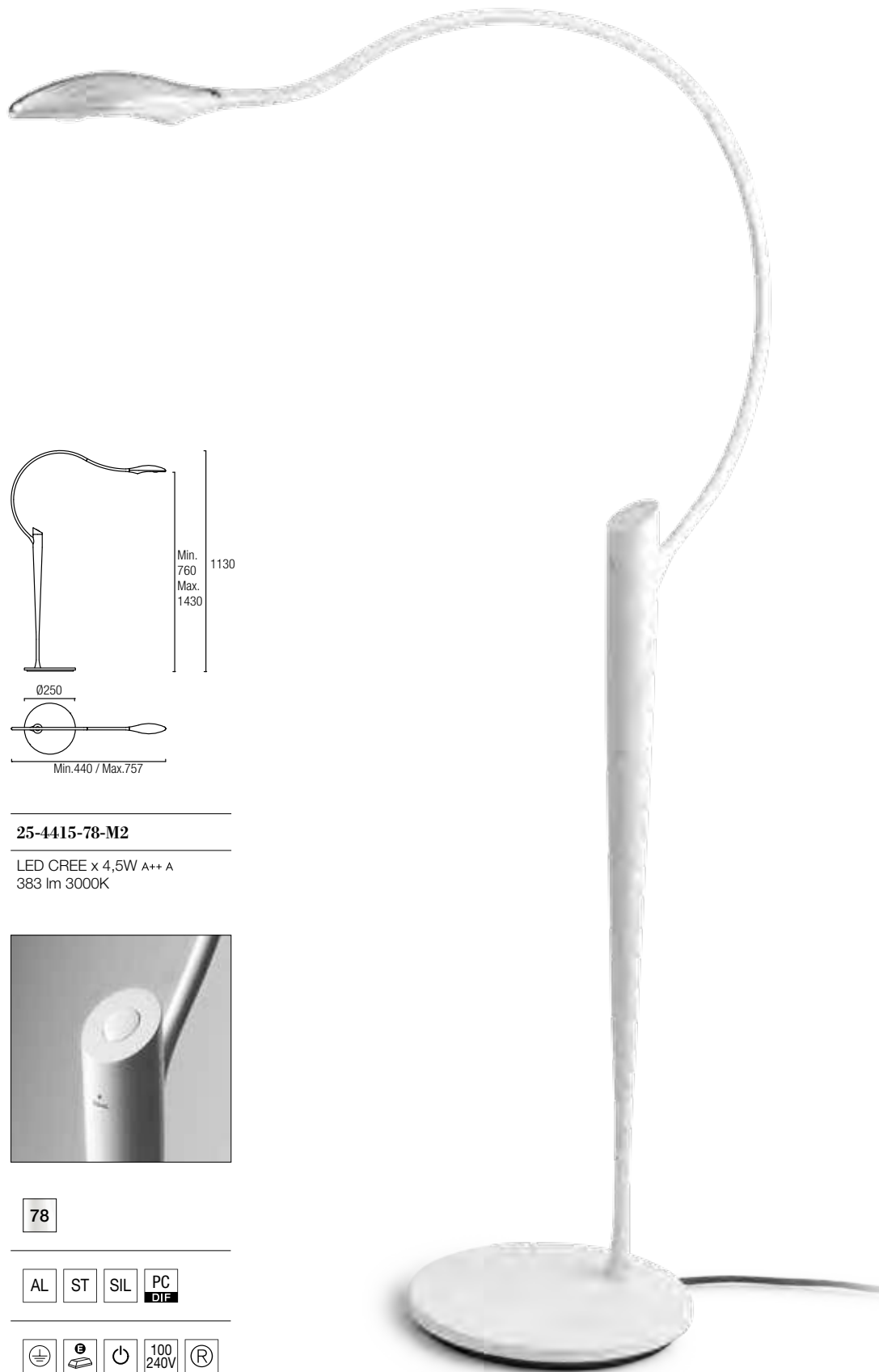

25-4415-78-M2

LED CREE x 4,5W A++ A
383 lm 3000K



78

AL ST SIL PC
DIF

⊕ e ⏻ 100 240V Ⓜ

CE W Light ⚡

200 270

/322

Totem

design Josep Patsí





Luz superior halógena
Halogen top light

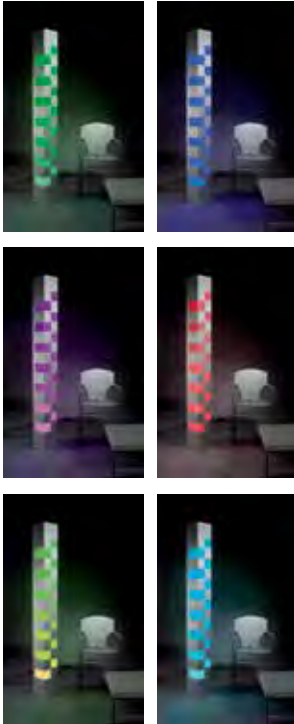

RGB color system with LEDS



HALOGEN LIGHT
ON THE TOP



VERTICAL
FLUORESCENT
LIGHT



LED COLOR
CONTROL
6-position push
button

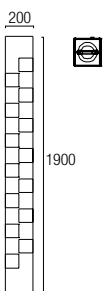

25-2384-AF-M1

1 x R7s L=118 Max. 300W OSRAM included
+ 1 x T8 58W included
+ 95 LEDS RGB COLOR SYSTEM
A++ C



General information

LÁMPARAS | LAMPS | LAMPES | LAMPEN | LAMPADINE |
LÂMPADAS | ЛАМПЫ | LAMPA

Los pedidos de lámparas siempre deben respetar las unidades de embalaje reflejadas en esta página. Todas las bombillas son de 1ª marca.

Light bulbs POs shall always be placed according to the packaging units reflected in the present page. All light bulbs are first quality.

Les commandes d'ampoules doivent toujours respecter les unités d'emballage figurant sur cette page. Toutes les ampoules sont de grande marque.









Bei Bestellungen von Leuchtmittel bitte die auf dieser Seite angegebenen Verpackungseinheiten beachten. Alle Leuchtmittel sind von namhaften Fabrikaten.

Gli ordini relativi alle lampadine devono tenere in conto le unità di imballaggio evidenziate in questa pagina. Tutte le lampadine sono di marca.

Os pedidos de lâmpadas devem respeitar sempre as unidades de embalagem refletidas nesta página. Todas as lâmpadas são de 1ª marca.

При составлении заказа необходимо учитывать количество единиц в упаковке, обозначенных на данной странице. Все лампы от лучших производителей.

Zamówienia na źródła światła powinny być przygotowywane zgodnie z pakowaniem pokazanym na tej stronie. Wszystkie źródła światła są najwyższej jakości.

	CÓDIGO CODE	CASQUILLO SOCKET	W	K	V	LM	HAZ ANGLE (°)	 I (Cd)	VIDA LIFE (h)	DIÁMETRO DIAMETER (mm)	LONGITUD LENGTH (mm)	EMBALAJE (mm) (alto x ancho x profundo) PACKAGING (mm) (height x width x depth)		
LED (LEDS-C4)														
	ACT-FLL-015	GU10	10	3.000	220-240	580	24°	•	4.200	>30.000	111	93	275 x 275 x 125	4
	ACT-FLL-017	GU10	10	3.000	220-240	580	35°	•	2.000	>30.000	111	93	275 x 275 x 125	4
	ACT-FLL-032	GU10	15	3.000	220-240	824	24°	•	6.000	>30.000	111	104	275 x 275 x 136	4
	ACT-FLL-033	GU10	15	3.000	220-240	872	35°	•	3.000	>30.000	111	104	275 x 275 x 136	4
	ACT-FLL-024	GU10	5	3.000	220-240	165	24°		1.200	>30.000	50	57	389 x 356 x 178	10
	ACT-FLL-025	GU10	5	3.000	220-240	160	35°		550	>30.000	50	57	389 x 356 x 178	10

- 1-El uso de lámparas de mala calidad, afecta directamente a la vida útil de la reactancia.
- 2-En los casos de reactancias de uso independiente utilizadas en downlights, es importante no cubrir el equipo con mantas térmicas utilizadas habitualmente para aislar los techos.
- 3-Después de un corte en el suministro eléctrico, es importante desconectar la luminaria de manera que cuando se reanude el suministro ésta se encuentre desconectada.
- 4-Importante tener la precaución de no combinar en una misma instalación equipos magnéticos y equipos electrónicos, ya que éste puede ser motivo de reducción de horas de vida de una reactancia electrónica.

- 1-Using bad quality lamps will directly affect the life span of the ballast.
- 2-When talking about ballasts for individual use commonly used in downlights, it's necessary to clarify that the gear cannot be covered with thermic blankets normally used to isolate ceilings.
- 3-After a power failure, it is important to unplug the light fitting, and it should be kept so when the power supply is renewed.
- 4-It is important to pay attention not to combine magnetic and electronic ballasts on the same installation, as this would reduce the life of the electronic ballasts.

- 1-L'utilisation d'ampoules de mauvaise qualité affecte directement la durée de vie utile du ballast.
- 2-Dans le cas des ballasts à utiliser indépendamment dans les downlights, il est important de ne pas couvrir ces dispositifs à l'aide des couvertures thermiques qui servent habituellement à isoler le plafond.
- 3-Après une coupure d'alimentation électrique, il importe de débrancher le luminaire de sorte que ce dernier se trouve éteint au rétablissement du courant.
- 4-Il convient de veiller à ne pas combiner dans une même installation des dispositifs magnétiques et des dispositifs électroniques, car cela peut réduire la durée de vie d'un ballast électronique.

- 1-Die Verwendung von Lampen geringer Qualität kann die Lebensdauer der elektronischen Vorschaltgeräte direkt beeinträchtigen.
- 2-Für einen einwandfreien Betrieb der unabhängigen elektronischen Vorschaltgeräte für die Downlights die Geräte nicht mit zur Dachisolierung verwendeten Dämmplatten abdecken.
- 3-Wenn es zu einem Stromausfall kommt, die Lampe ausschalten bzw. vom Stromanschluss trennen, damit sie bei Rückkehr der Stromversorgung abgeschaltet ist.
- 4-Es muss besonders darauf geachtet werden, in einer Anlage keine magnetischen und elektronischen Geräte zu kombinieren, da dies die Lebensdauer der elektronischen Vorschaltgeräte direkt beeinträchtigen kann.

- 1-L'utilizzo di lampade di cattiva qualità ha conseguenze negative sulla vita utile della reattanza.
- 2-Nei casi di reattanze di uso indipendente utilizzate nei downlight, è importante non coprire il dispositivo con coperte termiche normalmente utilizzate per isolare i soffitti.
- 3-Dopo un black-out, scollegare la lampada in modo che quando la corrente viene riallacciata la lampada sia scollegata.
- 4-È importante fare attenzione a non combinare dispositivi magnetici ed elettronici nella stessa installazione, poiché ciò può comportare una riduzione delle ore di vita di una reattanza elettronica.

- 1-A utilização de lâmpadas de fraca qualidade afeta diretamente o tempo de vida útil da reactância.
- 2-Nos casos de reactâncias de uso independente utilizadas em focos, é importante não cobrir o equipamento com mantas térmicas utilizadas normalmente para isolar os tetos.
- 3-Na sequência de um corte de energia elétrica, é importante desligar a luminária para que, aquando do restabelecimento, esta esteja desligada.
- 4-É importante ter o cuidado de não combinar numa única instalação equipamentos magnéticos e equipamentos eletrónicos, na medida em que esta situação pode causar a redução de horas de vida de uma reactância eletrónica.

- 1-Использование ламп ненадлежащего качества сокращает сроки эксплуатации ПРУ.
- 2-Для встраиваемых потолочных светильников в случае, если оборудование не встроено, запрещается его изолирование теплозащитными материалами, используемыми для изоляции потолка.
- 3-При отключении электроэнергии необходимо выключить светильник так, чтобы при возобновлении тока, светильник находился в отключенном состоянии.
- 4-Избегать одновременного подключения в одну сеть магнитного и электронного оборудования, поскольку это может привести к сокращению срока службы электронной ПРУ.

- 1-Używanie słabej jakości źródeł światła wpłynie negatywnie na żywotność układu zapłonowego.
- 2-Układy zapłonowe używane indywidualnie w lampach typu downlight nie mogą być przykrywane izolacją cieplną używaną do ocieplania sufitów.
- 3-Po zaniku prądu oprawy należy odłączyć od źródła prądu do momentu powrotu zasilania w sieci.
- 4-Ważnym jest, aby nie łączyć magnetycznych i elektronicznych układów zapłonów.

REF.	PAG.
00-0001-BW-M3	74
00-0002-BW-M3	74
00-0003-BW-M1	87
00-0049-AH-AH	118
00-0052-AH-AH	118
00-0053-05-BW	85
00-0054-05-BW	85
00-0056-05-M1	93
00-0056-BW-M1	93
00-0087-N3-F9	108
00-0338-Y6-Y6	123
00-0641-BW-M3	74
00-0642-BW-M3	74
00-0643-BW-M1	87
00-0778-05-M1	93
00-0778-BW-M1	93
00-0779-BW-M1	88
00-0826-BW-M1	88
00-1942-BW-M3	70
00-2397-Y5-E9	125
00-2407-AG-14	129
00-2726-AP-05	98
00-2726-AQ-78	98
00-2727-AP-05	98
00-2727-AQ-78	98
00-2801-14-M3	122
00-2804-21-F1	124
00-2872-05-M2	94
00-2872-25-M2	94
00-2872-78-M2	94
00-2924-BW-M1	80
00-2934-BW-M3V1	76
00-2935-BW-M3V1	76
00-3543-BW-BW	59
00-3543-F5-F5	59
00-3642-BW-M3	74
00-3643-BW-M3	76
00-3644-BW-M3	76
00-3646-BW-M3	74

REF.	PAG.
00-3647-BW-M3	73
00-3648-BW-M3	73
00-3649-BW-M3	73
00-3685-BW-M1	87
00-3687-CI-CIV1	64
00-3688-CI-CIV1	64
00-3689-CI-CIV1	64
00-3806-CI-CIV1	63
00-3813-BW-08	67
00-3813-BW-34	67
00-4034-CT-93	51
00-4348-21-F9	105
00-4348-BW-F9	105
00-4391-BW-03	113
00-4391-BW-05	113
00-4391-BW-25	113
00-4409-21-12	120
00-4413-21-M2	115
00-4416-05-23	103
00-4416-78-03	103
00-4424-21-M3	101
00-4425-21-M3	101
00-4601-21-05	127
00-4601-21-14	127
00-4607-21-05	127
00-4607-21-14	127
00-4615-21-05	127
00-4615-21-14	127
00-4872-BW-M3	78
00-4876-BW-M3	78
00-5079-05-05	25
00-5084-05-05	25
00-5275-BW-M1	47
00-5275-CT-M1	47
00-5278-21-21	27
00-5278-BW-BW	27
00-5279-21-37	27
00-5279-BW-37	27
00-5280-21-21	29

REF.	PAG.
00-5280-BW-BW	29
00-5281-21-37	29
00-5281-BW-37	29
00-5284-21-21	32
00-5284-BW-BW	32
00-5285-21-F1	32
00-5285-BW-F1	32
00-5286-21-21	35
00-5286-BW-BW	35
00-5287-21-F1	35
00-5287-BW-F1	35
00-5288-21-21	36
00-5288-BW-BW	36
00-5289-21-F1	36
00-5289-BW-F1	36
00-5290-21-F1	36
00-5290-BW-F1	36
00-5291-21-21	38
00-5291-BW-BW	38
00-5457-BW-F9	42
00-5457-Z5-F9	42
00-5458-BW-F9	42
00-5458-Z5-F9	42
00-5459-05-05	18
00-5460-05-05	20
00-5494-BW-BW	27
00-5495-BW-37	27
00-5496-BW-BW	29
00-5497-BW-37	29
00-5498-BW-M1	47
05-0047-BW-BW	184
05-0265-Y6-M1	207
05-0266-Y6-M1	207
05-0380-81-B8	205
05-0380-BW-B8	205
05-0381-81-AJ	193
05-0382-81-AJ	193
05-0658-BW-BW	187
05-1817-AF-AF	168

REF.	PAG.
05-1818-AF-AF	168
05-1819-27-27	168
05-1819-AF-AF	168
05-1819-BW-BW	168
05-1822-27-27	168
05-1822-AF-AF	168
05-1822-BW-BW	168
05-1940-81-81	197
05-1940-BW-BW	197
05-1941-81-82	196
05-1941-BW-82	196
05-2397-21-E9	177
05-2397-Y5-E9	177
05-2708-21-21	202
05-2708-AH-AH	202
05-2924-BW-M3	161
05-3544-25-25	165
05-3544-BW-BW	165
05-3686-21-T005	189
05-4394-78-M1V1	174
05-4394-AH-M1V1	174
05-4409-21-12	190
05-4415-78-M2	201
05-4716-03-M2	179
05-4717-03-M2	181
05-4750-14-F9	170
05-4787-81-81	198
05-4787-BW-BW	198
05-5077-21-21	155
05-5077-BW-BW	155
05-5078-21-21	158
05-5078-BW-BW	158
05-5079-05-05	153
05-5085-BW-BW	149
05-5092-81-B9	183
05-5092-BW-B9	183
05-5093-81-B9	183
05-5093-BW-B9	183
05-5276-BW-M1	137

REF.	PAG.
05-5458-BW-F9	139
05-5458-Z5-F9	139
05-5488-AH-AH	135
05-5488-BW-BW	135
05-5499-BW-BW	135
10-0055-BW-BW	269
10-1824-BW-T002	263
10-1824-BW-T003	263
10-1940-05-H13W	259
10-1940-BW-T007	259
10-2708-21-21	273
10-3686-21-T005	256
10-4391-BW-03	265
10-4391-BW-05	265
10-4391-BW-25	265
10-4409-21-12	266
10-4413-21-M2	267
10-4415-05-M2	270
10-4415-78-M2	270
10-5076-06-H13W	255
10-5458-BW-F9	251
10-5458-Z5-F9	251
15-0003-BW-M1	227
15-0056-BW-M1	235
15-0778-BW-M1	235
15-0835-BW-M1	227
15-1950-BW-M1	222
15-1956-BW-M1	222
15-1959-BW-M1	222
15-2411-BW-M1	225
15-2412-BW-BWV1	225
15-2782-78-78	241
15-2782-AH-AH	241
15-2804-21-F1	240
15-2806-14-M1	239
15-2807-14-M1	239
15-2870-AH-F1	236
15-2870-D8-F1	236
15-2870-D9-F1	236

REF.	PAG.
15-3231-81-81V1	231
15-3231-BW-BWV1	231
15-3535-CH-M1	228
15-3536-BW-M1	227
15-3537-CH-M1	228
15-3538-CH-M1	228
15-3825-CH-M1	228
15-4332-21-F9	245
15-4601-21-05	243
15-4601-21-14	243
15-4607-21-05	243
15-4607-21-14	243
15-4615-21-05	243
15-4615-21-14	243
15-4716-03-M2	247
15-4784-BW-BW	225
15-4785-81-81	231
15-4785-BW-BW	231
15-4871-BW-M3	217
15-4875-BW-M3	217
15-5094-S2-M1	233
15-5095-S2-M1	233
15-5096-S2-M1	233
15-5099-BW-BW	219
15-5099-D9-D9	219
15-5100-BW-BW	219
15-5100-D9-D9	219
15-5118-S2-M1	233
15-5119-S2-M1	233
15-5120-S2-M1	233
15-5277-BW-M1	215
15-5278-21-21	213
15-5278-BW-BW	213
15-5279-21-21	213
15-5279-BW-BW	213
15-5280-21-21	213
15-5280-BW-BW	213
15-5281-21-37	213
15-5281-BW-37	213

REF.	PAG.
15-5494-BW-BW	213
15-5495-BW-BW	213
15-5496-BW-BW	213
15-5497-BW-37	213
20-2407-AG-14	129
25-0057-BW-M1	306
25-0058-BW-M1	305
25-1823-BW-T002	295
25-1823-BW-T003	295
25-1824-BW-T002	295
25-1824-BW-T003	295
25-1837-05-05	299
25-1940-05-H13W	290
25-1940-BW-T007	290
25-2384-AF-M1	323
25-2407-AG-14	318
25-2410-BW-M3	308
25-2934-BW-M3	300
25-3230-CH-M3	310
25-3686-21-T005	288
25-4035-CT-93	276
25-4391-BW-03	313
25-4391-BW-05	313
25-4391-BW-25	313
25-4409-21-12	317
25-4413-21-M2	315
25-4415-78-M2	321
25-4786-AF-M1	285
25-4786-CT-M1	285
25-5076-06-H13W	281
71-0053-BW-BW	85
71-1759-BW-BW	295
71-2232-14-14	94, 103, 108
71-2241-00-00	73, 74, 76, 87, 88, 227, 228
71-2934-BW-BW	300
71-3544-25-25	165
71-3544-BW-BW	165

REF.	PAG.
71-4787-AV-AV	198
71-4817-F1-F1	57, 145
71-4818-F1-F1	57, 145
71-4819-CI-CIV1	145
71-4820-50-50V1	57
71-4821-CU-CU	57, 145
71-4824-20-20	57, 145
71-4824-CI-CI	57, 145
71-4825-CI-CI	57, 145
71-4940-CI-CI	57, 145
71-5490-CI-CI	145
71-5491-00-00	145
IBIS C/27-81	231
IBIS C/37-81	231
IBIS C/37-BW	231
IBIS C/47-81	231
IBIS C/47-BW	231
PAN 178-14	194
PAN 178-BY	194
PAN-157-14	194, 196
PAN-157-BY	194, 196
PAN-161-14	194, 196
PAN-161-BY	194, 196
PAN-175-14	194
PAN-175-BY	194
PAN-176-14	194, 196
PAN-176-BY	194, 196
PAN-177-14	194, 196
PAN-177-BY	194, 196
PAN-179-14	194, 196
PAN-179-BY	194, 196
PAN-180-14	194
PAN-180-BY	194
PAN-194-AJ	194, 196

ABS

ABS • ABS • ABS • ABS • ABS • ABS • ABS • ABS

PMMA

PMMA • PMMA • PMMA • PMMA • PMMA • PMMA • PMMA • PMMA • PMMA

AL

Aluminio • Aluminium • Aluminium • Aluminium • Alluminio • Aluminio • Алюминий • Aluminium

GLASS
BOSI

Vidrio de borosilicato • Borosilicate glass • Verre borosilicaté • Borosilikatglas • Vetro borosilicato • Vidro de borossilicato • Боросиликатное стекло • Szkło borokrzemianowe

GLASS
MAT

Vidrio mate • Matt glass • Verre mat • Matter Glas • Bicchiere mat • Vidro mate • Матовое стекло • Szkło matowe

GLASS
OPAL3

Cristal opal triplex • Triplex Opal glass • Verre opal triplex • Optishes Glas • Vetro ottico • Cristal opala triplo • Стекло опаловый триплекс • Trójwarstwowe szkło opalowe

GLASS
OPT

Cristal óptico • Optic glass • Verre optique • Optishes Glas • Vetro ottico • Cristal óptico • Оптическое стекло • Szkło optyczne

GLASS
TRANS

Cristal transparente • Transparent glass • Verre transparent • Transparenter Glas • Bicchiere transparente • Cristal transparente • Прозрачное стекло • Przezroczyste szkło

FELT

Fieltro • Felt • Feutre • Filz • Stoffa di lana • Feltro • Фильтр • Filc

PC

Polycarbonato • Polycarbonate • Polycarbonate • Polykarbonat • Polycarbonato • Polycarbonato • Поликарбонат • Poliwęglan

PE

Polietileno • Polyethylene • Polyéthylène • Polyethylen • Polietilene • Polietileno • Полиэтилен • Polietylen

PS

Poliestireno • Polystyrene • Polystyrène • Polystyrol • Polistirolo • Poliestireno • Рассеиватель • Polistyren

PUR

Poliuretano • Polyurethane • Polyuréthane • Polyurethan • Poliuretano • Poliuretano • Полиуритан • Poliuretán

PVC

PVC • PVC • PVC • PVC • PVC • PVC • PVC • PVC

SIL

Silicona • Silicone • Silicone • Silikon • Silicone • Silicone • Силикон • Silikon

ST

Acero • Steel • Acier • Stahl • Acciaio • Aço • Сталь • Stal

TEX
TIL

Tela • Fabric • Tissu • Stoff • Tela • Tela • Ткань • Tkanina

ZAMAK

Zamak • Zamak • Zamak • Zamak • Zamak • Zamak • Zamak • Zamak • Zamak

03 T002

Gris • Grey • Gris • Grau • Grigio • Cinzento • Серый • Szary

05 H13W

Negro • Black • Noir • Schwarz • Nero • Preto • Черный • Czarny

06

Cobre • Copper • Cuivre • Kupfer • Rame • Cobre • медь • miedziany

08

Verde • Green • Vert • Grün • Vert • Verde • ЗЕЛЕНЬИЙ • Zielony

14 T003 T007

Blanco • White • Blanc • Weiß • Bianco • Branco • Белый • Biały

12

Difusor acrílico fumé • Smoked acrylic diffuser • Diffuseur acrylique fumé • Acryldiffusor geräuchert • Diffusore in acrílico fumé • Difusor acrílico fumado • Акриловый рассеиватель из коричневого стекла • Zadymlony dyfuzor akrylowy

20 BY

Beige • Beige • Beige • Beige • Beige • Bege • бежевый • Bez

21

Cromo • Chrome • Chrome • Chrom • Cromo • Cromo • Хром • Chromowany

23

Dorado • Golden • Doré • Golden • Oro • Dourado • Позолоченный • Złoty

25

Rojo • Red • Rouge • Rot • Rosso • Vermelho • Красный • Czerwony

27

Latón satinado mate • Matt satin finished brass • Laiton satiné mat • Messing, satiniert matt • Ottone satinato opaco • Latão acetinado mateo • Латунь-сатин матовая • Matowy mosiądz satynowany

50

Latón pulido • Polish brass • Laiton poli • Messing poliert • Ottone levigato • Latão polido • Полированная латунь • Mosiądz polerowany

78

Lacado blanco • White lacquered • Laqué en blanc • Weiß lackiert • Laccato bianco • Lacado branco • Белый лак • Polakierowany na bialo

81

Níquel satinado • Satin nickel • Nickel satiné • Nickel satiniert • Nichel satinato • Níquel acetinado • Сатинированный никель • Szcztokowany nikiel

AH

Aluminio ecobright • Ecobright aluminium • Aluminium Ecobright • Aluminium Ecobright • Aluminio ecobright • Aluminio ecobright • Алюминий Экобрайт • Aluminium ecobright

AF S2 Y6

Aluminio satinado • Satin aluminium • Aluminium satiné • Aluminium matt • Alluminio satinato • Aluminio acetinado • Сатинированный алюминий • Aluminium satynowe

AG

Aluminio con cromo • Aluminium with chrome • Aluminium avec chrome • Aluminium mit Chrom • Aluminio con cromo • Aluminio com cromo • Алюминий с хромом • Aluminium z chromem

AJ

Gris Ópera • Opera grey • Gris opéra • Opera grau • Grigio • Gris opera • Серебрянный шелк • Opera szary

AQ CH

Gris metalizado • Metallic grey • Gris métallisé • Metallisch-grau • Grigio metallizzato • Cinza metalizado • Серый металл • Metaliczny szary

AQ

Pantalla interior plisada plata • Silver pleated interior shade • Intérieur d'abat-jour plissé argenté • Innenseite silber Plissee • Paralume interna plisada argento • Abat-jour interior plissado prateado • Внутренний габрированный плафон серебряного цвета • Srebrny abażur wewnętrzny z zakładkami

AP

Pantalla interior plisada dorada • Golden pleated interior shade • Intérieur d'abat-jour plissé doré • Innenseite gold Plissee • Paralume interna plisada oro • Abat-jour interior plissado dourado • Внутренний габрированный плафон цвета позолоты • Złoty abażur wewnętrzny z zakładkami

BW

Blanco mate • Matt white • Blanc mate • Weiß matt • Bianco opaco • Branco fosco • Белый матовый • Matowy biały

CI

Marrón • Brown • Marron • Braun • Marrone • Castanho • Коричневый • Brązowy

CU

Naranja • Orange • Orange • Orange • Arancione • Laranja • Оранжевый • Pomarań czowy

D8

Pan de Oro • Golden leaf • Feuille d'or • Blattgold • Foglia di oro • Capa de ouro сусальное золото • Złoto platkowe

D9

Pan de plata • Silver leaf • Feuille d'argent • Blattsilber • Foglia argento • Capa de prata • Сусальное серебро • Srebro platkowe

F5

Oro pintado • Painted gold • Or peint • Goldfarben lackiert • Oro verniciato • Ouro pintado • Окра ска под позолоту • Malow ane złoto

N3

Gris textura • Grey texture • Gris à effet de texture • Grau matt • Grigio • Cinzento textura • Текстурный серый • Szary tekstury

Y5

Aluminio mate • Matt aluminium • Aluminium mat • Aluminium matt • Alluminio opaco • Aluminio mate • Матовый алюминий • Matowe aluminium



Clase I • Class I • Classe I • Classe I • Classe I •
Clase I • Класс I • Klasa I



Clase II • Class II • Classe II • Classe II • Classe II •
Clase II • Класс II • Klasa II



Clase III • Class III • Classe III • Classe III • Classe III •
Clase III • Класс III • Klasa III



Luminarias no adecuadas para cubrirse con material aislante térmico • Luminaires should never be covered with any heat insulating material • Les luminaires ne devraient pas être couverts par du matériel isolé thermique • Nicht geeignet für eine Installation in einer isolierten Decke • Apparecchi inappropriati per essere coperti con materiale isolante termico • Estas luminárias não podem ser cobertas com material isolante térmico • Не допускается теплоизоляция данных светильников • Ограду nigdy nie powinny być przykrywane materiałem izolującym ciepło.



Luminarias no adecuadas para el montaje directo en superficies normalmente inflamables • Non suitable for direct installation on normally inflammable surfaces • Luminaires inadéquates pour le montage direct sur des surfaces qui sont normalement inflammables • Montage auf normalerweise entflammbaren Oberflächen nicht zulässig • Apparecchi inappropriati per montaggio su superfici infiammabili • Estas luminárias não podem ser montadas diretamente sobre superficies normalmente inflamáveis • Не допускается установка данных светильников на легковоспламеняющихся поверхностях • Nie instalować bezpośrednio na powierzchniach łatwopalnych.



Fabricado según normas de seguridad y electromagnetismo de Europa • Manufactured according to the set safety and electromagnetism standards of Europe • Fabriqués en conformité avec les normes de sécurité et d'électromagnétique de l'Europe • Hersgestellt nach den in Europa geltenden Sicherheits- und elektromagnetischen Bestimmungen • Tutti i prodotti fabbricati rispettano le norme di sicurezza e di elettromagnetismo europee • Fabricado de acordo com as normas de segurança e electromagnetismo da Europa • Изготовлено в соответствии с европейскими стандартами для электронного и электромагнитного оборудования. • Wyprodukowane zgodnie z zasadami europejskich standardów bezpieczeństwa i elektromagnetyki.



Resistente al hilo incandescente a 850°C • Resistance to incandescent wire at 850°C • Tenue au feu 850°C • Glühdrahtbeständig auf 850°C • Resistente a filo incandescente 850°C • Resistente ao fio incandescente a 850°C • Прошло испытание спиралью накаливания 850°C • Odporność na drut żarowy o temperaturze 850°C



Distancia mínima entre el foco de la luminaria y el objeto iluminado • Minimum distance to be left between the focus of the lighting fixture and the lightened object • La distance minimum pour être gauche entre le foyer de l'accessoire d'éclairage et l'objet allumé • Mindestabstand zwischen dem Scheinwerfer der Leuchte und dem beleuchteten Gegenstand • Distanza minima tra la lampada e l'oggetto illuminato • Distância mínima entre o foco da luminaria e o objeto iluminado • Минимальное расстояние между световым фокусом и освещаемым объектом. • Minimalna odległość do zachowania pomiędzy czołem lampy a oświetlanym obiektem.



Sistema de codificación para indicar el grado de protección proporcionado por una envoltura contra la entrada de elementos sólidos y líquidos • A coding system that shows the degree of protection that a casing provides against the penetration of solid objects or dust and liquids • Système de codification permettant d'indiquer le degré de protection procuré par une enveloppe contre la pénétration de corps solides, poussières et liquides • Dieses Codierungssystem dient zur Angabe des Schutzgrades, der mit einer besonderen Verkleidung zum Schutz gegen das Eindringen fester Gegenstände, Staub oder Flüssigkeiten erreicht wird • Sistema di codifica per indicare il grado di protezione offerto da un involucro contro la penetrazione di oggetti solidi, di polvere, o di liquidi • Sistema de codificação para a indicação do grau de proteção proporcionado por um invólucro contra a penetração de objetos sólidos ou pó e líquidos • Система кодирования для обозначения степени защиты корпуса против попадания твердых и жидких элементов • System kodowania wskazujący na stopień ochrony przed wnikaniem ciał obcych, kurzu i wody.



Instalación en el techo • Ceiling installation • Installation au plafond • Deckenmontage • Installazione a soffitto • Instalação no tecto • Установка под потолком • Instalacja sufitowa



Dirección del halo de luz • Halo light direction • Direction du faisceau lumineux • Halo Lichtrichtung • Direzione del Fascio di luce • Direcção do feixe de luz • Направление света. • Kierunek fali światła



Uds. de embalaje • Items per box • Unité d'emballage • Verpackungseinheiten • Unità d'imballaggio • Uds. de embalagem • Количество единиц в коробке • Sztuk w pudełku



Luz cálida • Warm light • Lumière chaude • Warmweißes Licht • Luce calda • Luz quente • Тёплый свет • Ciepłe światło



Modelos registrados • Registered models • Modèles enregistrés • Eingetragene Modelle • Modelli registrati • Modelos registados • Зарегистрированные модели • modele zastrzeżone



Material difusor • Diffuser material • Materialu diffusant • Difuseur Material • Materiale diffusore • Material difusor • Материал диффузора • Materiał rozpraszający



Material pantalla • Shade material • Matériels Abat-jour • Material des Schirmes • Materiale del paralume • Material Abajur • Материал абажура • Materiał abazuru



Equipo electrónico • Electronic gear • Equipement électronique • Elektronische Vorschalgerät • Dispositivo electrónico • Aparelho electrónico • Электронный балласт • Osprzet elektroniczny



Regulador de intensidad • Dimmer • Régulateur d'intensité • Mit dimmer • Con regolatore d'intensità • Com regulador de intensidade • Регулятор яркости • Ściemniacz



Regulador de intensidad táctil • Touch dimmer • Variateur d'intensité tactile • Regler zur Einstellung der Berührungintensität • Regolatore tattile dell'intensità • Variador de intensidade táctil. • Сенсорный диммер • Ściemniacz dotykowy



Interruptor de encendido • On/off switch • Interrupteur simple allumage • Schalter • Interruttore di accensione • Interruptor on/off • Клавишный выключатель • Włącznik



Doble interruptor de encendido • Double on/off switch • Interrupteur double allumage • Doppel Schalter • Doppio interruttore di accensione • Duplo interruptor on/off • Два клавишных выключателя • Włącznik podwójny



Interruptor de encendido en el cable • Cable on/off switch • Interrupteur d'allumage sur le câble • Schalter am Kabel • Interruttore d'accensione nel cavo • Cabo com interruptor on-off • Выключатель на проводе • Wyłącznik w przewodzie



Interruptor de cuerda • Pull cord switch • Interrupteur à ficelle • Strickschalter • Interruptor de cordão • Interruttore a corda • Вербочный выключатель • Włącznik sznurowy



Mando a distancia • Remote control • Télécommande • Fernbedienung • Telecomando • Comando à distância • Пульт управления • Pilot zdalnego sterowania



Controlador con mando a distancia • Controller with remote control • Contrôleur avec télécommande • Controller mit Fernbedienung • Regolatore con telecomando • Controlador com comando à distância • Контроллер с дистанционным управлением • Nastawnik z pilotem zdalnego sterowania



Pilas incluidas • Batteries included • Piles fournies • Batterien inklusive • Pile incluse • Pilhas incluídas • Батарейки в комплекте • Łącznie z bateriami



Consulte con equipo comercial • Please, contact our sales team • Consultez l'équipe commerciale • Bitte wenden Sie sich an unsere Vertriebsmitarbeiter • Consultare il team di vendita • Consulte a n/ Equipa Comercial • Проконсультируйтесь у наших менеджеров по продажам • Proszę skonsultować się z działem handlowym



A++ A
A+ A
A++ B
A++ C

Eficiencia energética • Energy Efficiency • Efficience énergétique • Energieeffizienz • Efficienza Energetica • Eficiência Energética • Энергосбережение • Efektywność energetyczna

INFORMACIÓN GENERAL | GENERAL INFORMATION | INFORMATION GÉNÉRALE | ALLGEMEINE INFORMATIONEN | INFORMAZIONE GENERALE | INFORMAÇÃO GERAL | ОБЩАЯ ИНФОРМАЦИЯ | OGÓLNA INFORMACJA

• Debido a la constante evolución tecnológica del LED, los productos que incluyen esta fuente de luz pueden experimentar variaciones en sus características técnicas con el objetivo de poder ofrecer siempre las máximas prestaciones en nuestros productos. • Las descripciones y medidas de los aparatos del presente catálogo son orientativas, pudiendo por tanto ser modificadas, a fin de mejorar las características técnicas o de diseño. • La empresa se reserva el derecho de anular o modificar cualquier modelo sin previo aviso. • Los acabados y las especificaciones técnicas corresponden a los productos que se suministran en Europa, pudiendo éstos variar en otros mercados. • Para una buena conservación de las lámparas, no usar bombillas de potencia superior a las recomendadas y limpiar simplemente con un paño seco. No usar limpia metales, ya que dañan los barnices protectores que garantizan la duración del acabado.

• Due to the constant evolution of LED technology, those products which contain this light source can vary in their technical characteristics so as to ensure that we can always offer maximum product performance. • The descriptions and dimensions of the items in this catalogue are indicative and may be modified for the purpose of technical or design improvements. • We reserve the right to cancel or change all models without prior notice. • The finishes and technical specifications listed here are for the European market and may vary elsewhere. • Do not use stronger bulbs than recommended, and always clean lamps with a soft dry cloth alone since metal polish will damage the protective finish.

• En raison de l'évolution constante de la technologie LED, les produits dotés de cette source lumineuse peuvent connaître des variations dans leurs caractéristiques techniques, en vue de toujours en optimiser les prestations. • Les descriptions et mesures des appareils de ce catalogue sont données à titre d'orientation, pouvant être modifiées dans le but d'améliorer les caractéristiques techniques ou de design. • L'usine se réserve le droit d'annuler ou modifier l'un ou l'autre de ses modèles sans avis préalable. • Les finitions et spécifications techniques correspondent à la demande du marché européen. Elles peuvent être modifiées pour d'autres pays. • Ne pas utiliser d'ampoules d'une puissance supérieure à celle recommandée. Pour un bon entretien, utiliser simplement un chiffon sec. N'utilisez aucun produit pour métaux, ils abîment le vernis protecteur.

• Aufgrund der kontinuierlichen Fortschritte bei der LED-Technik, mit denen wir sicherstellen, dass wir stets Artikel auf dem neusten Stand der Technik liefern, können sich die Merkmale der Produkte dieser Lichtquelle ändern. • Die Beschreibung und Maße der in diesem Katalog aufgeführten Modelle dienen der Orientierung und können zur Verbesserung der technischen Eigenschaften oder des Designs geändert werden. • Der Hersteller behält sich das Recht vor, Modelle zu ändern oder aus dem Programm zu nehmen. • Die Ausführungen und technischen Daten gelten für den europäischen Markt und können in anderen Ländern abweichen. • Für eine gute Erhaltung der Leuchten ist der Betrieb mit Lampen höherer Leistung als empfohlen zu vermeiden. Zur Reinigung benutzen Sie einfach ein trockenes Tuch, da Metallputzmittel die Schutzlackierung angreifen.

• A causa della costante evoluzione tecnologica del LED, i prodotti che contengono questa fonte di luce possono subire variazioni nelle loro caratteristiche tecniche con l'obiettivo di offrire sempre massime prestazioni. • Le descrizioni e le dimensioni degli articoli del presente catalogo vengono fornite a mero titolo orientativo e possono pertanto essere modificate al fine di migliorarne le caratteristiche tecniche o di design. • La Casa si riserva il diritto di cessare la produzione o di modificare qualsiasi modello senza preavviso. • Le rifiniture e le specifiche tecniche corrispondono ai prodotti venduti in Europa; tali dati possono pertanto variare su altri mercati. • Per una buona conservazione delle lampade, non utilizzare lampadine di potenza superiore a quella consigliata e pulirle semplicemente con un panno asciutto. Non utilizzare prodotti per la pulizia del metallo che potrebbero rovinare le vernici di protezione che garantiscono la vita della rifinitura.

• Devido à constante evolução tecnológica do LED, os produtos que incluem esta fonte de luz podem apresentar variações nas suas características técnicas com o objetivo de garantir sempre o máximo desempenho dos nossos produtos. • As descrições e medidas dos modelos do presente catálogo são orientativas podendo, portanto, ser modificadas com o fim de melhorar as características técnicas ou de desenho. • Medidas em cm. • LEDS reserva-se o direito de anular ou modificar qualquer modelo sem aviso prévio. • Para uma boa conservação dos aparelhos, nunca usar lâmpadas de potência superior à recomendada nem usar produtos para limpeza de metais porque podem danificar os vernizes de proteção que garantem a duração do acabamento. Para limpeza usar apenas um pano seco. • Recomenda-se não molhar as luminárias com água de rega que contenha um elevado grau de sais ou ácidos. • As potências indicadas para as lâmpadas PL electrónicas correspondem às marcas Osram, Philips ou GE indistintamente, excepto se se especifica alguma marca em concreto.

• В силу постоянного технологического прогресса в области производства светодиодов, технические характеристики нашей продукции, в которой используется этот источник света, могут претерпевать изменения, всегда с целью обеспечения наилучших потребительских свойств. • Описания и размеры, фигурирующие в этом каталоге, являются приблизительными, поэтому они могут изменяться в случае улучшения технических характеристик или дизайна изделий. • Фирма-изготовитель оставляет за собой право на снятие с производства или модификацию любой модели без предупреждения. • Типы отделки и технические характеристики соответствуют продукции, поставляемой в Европу; на иных рынках данные показатели могут меняться. • Для обеспечения максимального срока службы светильников, не рекомендуется использовать лампы, мощность которых, превышает рекомендованную. Для гигиенической обработки светильника используйте сухую тряпку. Не используйте средства для чистки металлов, так как они могут повредить лак, покрывающий и защищающий внешнюю сторону светильника.

• Z uwagi na ciągły rozwój technologiczny LED, produkty które zawierają to źródło światła mogą ulegać zmianom pod względem właściwości technicznych, tak aby móc zawsze oferować maksymalną ilość świadczeń w naszych produktach. • Opisy i wymiary urządzeń z niniejszego katalogu są orientacyjne, mogą zatem ulec zmianie w celu ulepszenia właściwości technicznych lub wzornictwa. • Firma zastrzega sobie prawo do wycofania lub zmodyfikowania jakiegokolwiek modelu bez wcześniejszego uprzedzenia. • Wykończenia i specyfikacje techniczne odpowiadają produktom jakie są dostarczane w Europie, mogą one różnić się na innych rynkach. • Dla odpowiedniej konserwacji lamp nie stosować żarówek o mocy wyższej niż zalecana i czyścić suchą szmatką. Nie stosować środków do czyszczenia metali, gdyż uszkadzają one lakiery ochronne, które zapewniają trwałość wykończeń.

• Todos los derechos reservados. Ninguna parte de este libro puede ser reproducida en ningún formato de papel o electrónico, sin el consentimiento previo del editor o de los propietarios de los derechos.

• All rights reserved. No part of this publication may be reproduced or transmitted in any form or by any means, electronic storage and retrieval system, without permission in writing from the copyright owner (s).

• Tous droits réservés. Aucune partie de ce livre ne pourra être reproduite en format papier ou électronique sans l'autorisation préalable de l'éditeur ou du propriétaire des droits.

• Sämtliche Rechte vorbehalten. Kein Teil dieses Buches darf in keinem Papier- oder elektronischem Format ohne ausdrückliche Zustimmung des Herausgebers oder der Inhaber der Urheberrechte wiedergegeben oder vervielfältigt werden.

• Tutti i diritti riservati. Nessuna parte di questo libro può essere riprodotta in nessun formato cartaceo o elettronico, senza la previa autorizzazione dell'editore o dei proprietari dei diritti.

• Todos os direitos reservados. Nenhuma parte deste livro pode ser reproduzida em nenhum formato de papel ou electrónico, sem o consentimento prévio do editor ou dos proprietários dos direitos.

• Все права защищены. Запрещено использование любого материала из данного каталога без разрешения носителя прав собственности.

• Wszystkie prawa zastrzeżone. Żadna część niniejszej publikacji nie może być powielana w żadnym formacie papierowym ani elektronicznym bez wcześniejszej zgody wydawcy lub właścicieli tych praw.

Otros catálogos

Other catalogues

/335



THE ONE

Technical
Decorative
Outdoor



HOSPITALITY

Iluminación para hoteles
Hotel lighting
Éclairage hôtelier
HotelBeleuchtung
Illuminazione per hotel
Iluminação para hotéis
Освещение для отелей
Oświetlenie dla hoteli



RETAIL

Iluminación comercial
Commercial lighting
Éclairage commercial
shopBeleuchtung
Illuminazione commerciale
Iluminação comercial
Освещение для торговых
помещений
Oświetlenie handlowe

CLOSE TO YOU

HEADQUARTERS

LED S-C4, S.A.

Afores s/n 25750 Torà (Lleida)
SPAIN
Tel.: + 973 468 100
e-mail: leds-c4@leds-c4.com

CUSTOMER SERVICE DEPARTMENT

ESPAÑA

Tel.: + 34 973 468 101
e-mail: spain@leds-c4.com

UK

Tel.: 0808 234 2641
e-mail: uk@leds-c4.com

FRANCE

Tel.: + 34 973 468 130
e-mail: france@leds-c4.com

GERMANY

Tel.: 0800 188 0989

ITALIA

Tel.: 800 784 275
e-mail: italia@leds-c4.com

PORTUGAL

Tel.: + 34 973 468 130
e-mail: portugal@leds-c4.com

EUROPE

Tel.: + 34 973 468 102
e-mail: europe@leds-c4.com

AMÉRICA LATINA

Tel.: + 34 973 468 115
e-mail: latinamerica@leds-c4.com

USA - CANADA

Tel. USA: + 1-888-3710243
Tel. Canada: + 1-866-5636666
e-mail: usa@leds-c4.com

ASIA - PACIFIC & AFRICA

Tel.: + 34 973 468 116
e-mail: asiapacific@leds-c4.com
africa@leds-c4.com



MIDDLE EAST COUNTRIES

LED S-C4 LIGHTING DMCC

Fortune Executive Tower – JLT
PO 336910 – DUBAI – UAE
Tel. + 971 4458 4272
e-mail: middleeast@leds-c4dubai.com

POLAND

LED S-POLSKA SP. Z O.O.

ul.Nektarowa 11B 52-210. Wrocław
POLAND
Tel.: + 48 71 733 64 01
e-mail: biuro@leds-polska.pl



 **LEDs-C4**

Afueras s/n
25750 Torà (Lleida)
SPAIN

www.leds-c4.com